

**WANG**

3102

**FLEXIBLE  
DISK DRIVE**

**Models:**

<b>640</b>	<b>2242</b>
<b>749</b>	<b>2243</b>
<b>2240</b>	

**Customer Engineering  
Product Maintenance Manual**

**729-0134-A**

## PREFACE

This publication is a combined reprint of 729-0134 and 729-0135 for ease of handling and stocking.

The purpose of this manual is to provide the Wang-trained Customer Engineer (CE) with instructions to operate, troubleshoot and repair the Wang Flexible Disk Drives.

### Second Edition (February, 1984)

This edition is a reprint of and obsoletes 729-0134 and 729-0135. The material in this document may only be used for the purpose stated in the Preface. Updates and/or changes to this document will be published as Publication Update Bulletins (PUBs) or subsequent editions.

This document is the property of Wang Laboratories, Inc. All information contained herein is considered company proprietary, and its use is restricted solely for the purpose of assisting the Wang-trained CE in servicing this Wang product. Reproduction of all or any part of this document is prohibited without the prior consent of Wang Laboratories, Inc.

© Copyright WANG Labs., Inc. 1984

**SERVICE  
BULLETIN  
NO. 46**

EDITED BY PRODUCT SERVICE DEPT.

---

MODEL 640/740/2240 DUAL REMOVABLE  
FLEXIBLE DISK DRIVE

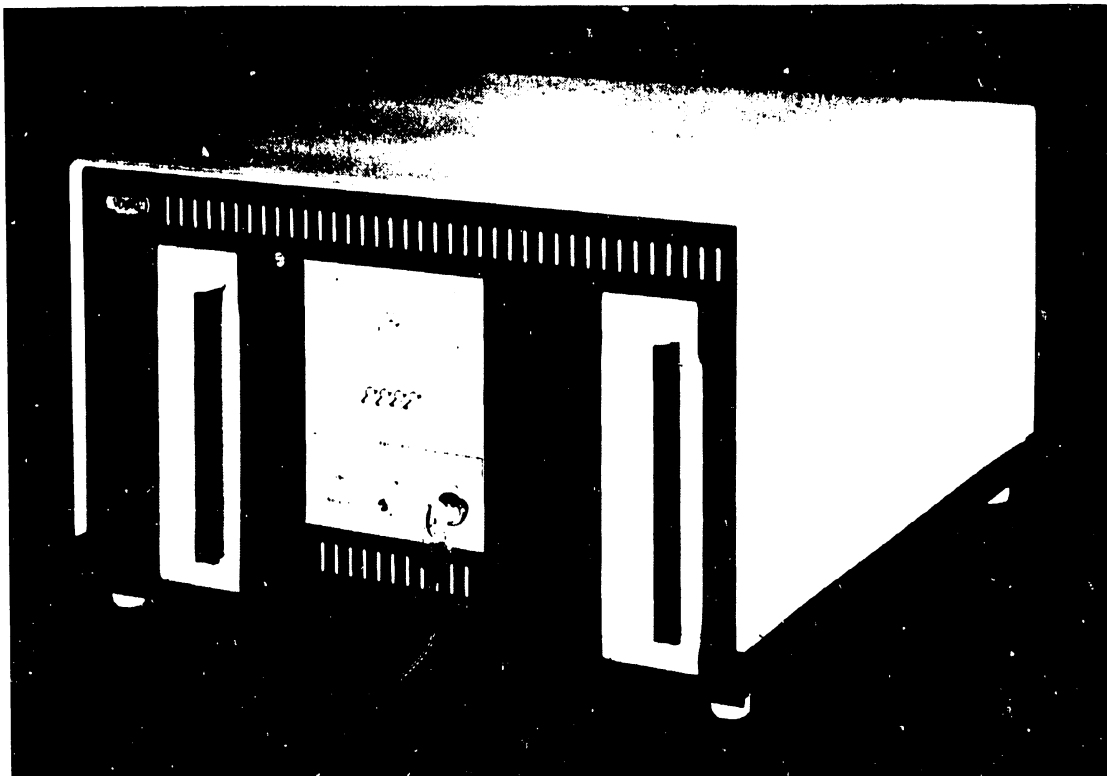

**NOTICE:**

This document is the property of Wang Laboratories, Inc. Information contained herein is considered company proprietary information and its use is restricted solely to the purpose of assisting you in servicing Wang products. Reproduction of all or any part of this document is prohibited without the consent of Wang Laboratories.

**WANG**

LABORATORIES, INC.

836 NORTH STREET, TEWKSBURY, MASSACHUSETTS 01876, TEL (617) 851-4111, TWX 710 343-6709, TELEX 94-7421

Printed in U.S.A.  
13-210

## TABLE OF CONTENTS

1.	DESCRIPTION	3
	1.1 General	3
	1.2 Special Features	4
	1.3 Hardware Nomenclature	4
2.	INSTALLATION	16
3.	OPERATION	19
	3.1 Indicator Lights and Switches	19
	3.2 Loading and Handling of Disk Cartridges	20
	3.3 Disk Formatting	22
	3.4 Model 740 Operation	23
	3.5 Model 640 Operation	25
	3.6 Model 2240 Operation	26
4.	DIAGNOSTICS	27
	4.1 Model 740 Diagnostic	27
	4.2 Model 640 Diagnostics	30
	4.3 Model 2240 Diagnostics	33
5.	MAINTENANCE	35
	5.1 Head Radial Alignment Check	38
	5.2 Head Radial Alignment Procedure	40
	5.3 Index and Sector Sensing Components	42
	5.4 Carriage Stop Adjustment Procedure	45
	5.5 Track 00 Switch Assembly	46
	APPENDIX A - 640 Beginning and Ending Track Addresses	48
	APPENDIX B - 740 Beginning and Ending Track Addresses	50
	APPENDIX C - 2240 Beginning and Ending Track Addresses	52
	APPENDIX D - Conversion from 640/740 to 2240	54

## 1. DESCRIPTION

### 1.1 GENERAL

The Model 40 is a compact, direct access, removable disk unit made up of two Memorex<sup>R</sup> 651 Disk Drives and a Wang Controller.

The controller for both drives is located behind the control panel and consists of the following printed circuit boards:

- 1) 352 regulator
- 2) 6296 micro processor
- 3) \*6297 micro processor
- 4) 6298 ROM
- 5) 6390 motherboard
- 6) 6391 power supply
- 7) 6392 front panel
- 8) 6395 interface
- 9) 6399 disk control

\*Per ECN #4074, the 640/2240 use a 6297-1 and the 740 uses a 6297-2.

The 651 drives are placed on either side of the controller and are referred to as Left and Right. The left and right drives utilize FD/IV Flexible Disk Cartridges each having a capacity of up to 262,144 bytes producing a unit with a maximum of 524,288 bytes. The disk cartridges are interchangeable from one drive to another.

The Model 40 can replace the 710-1 Disk Drive; all addressing and read/write commands are identical with a few exceptions.

<sup>R</sup> Registered Trademark, Memorex Corporation

## 1.2 SPECIAL FEATURES

The Model 40 contains the following design features:

- 1) Compact: Allows easy exchange of disk drives.
- 2) Compatibility: Permits the disk cartridges to be swapped between drives and units.
- 3) Interlocks: Contains interlocks which prevent damage to a disk cartridge during loading or unloading.
- 4) Write Protect: Logic is provided to disable the write circuits should the user wish to protect data recorded on the disk.
- 5) Byte addressing and multiple byte transfer to make it compatible with 710 DMS's (740 only).
- 6) Cyclic Redundancy Check: A built-in check to insure that data is read correctly.

## 1.3 HARDWARE NOMENCLATURE

### 1.3.1 Memorex<sup>R</sup> Portion

The Read, Write, Safety and Control Logic are the interface electronics between the Wang controller and the 651 drive (shown in Figure 1).

The electronic circuits are packaged on one PC board and contain:

- 1) Sector/Index Detector Circuits
- 2) Track Position Actuator Driver
- 3) Head Load Actuator Driver
- 4) Read/Write Amplifier and Transition Detector
- 5) Data/Clock Separation Circuits
- 6) Safety Sensing Circuits

<sup>R</sup>Registered Trademark, Memorex Corporation

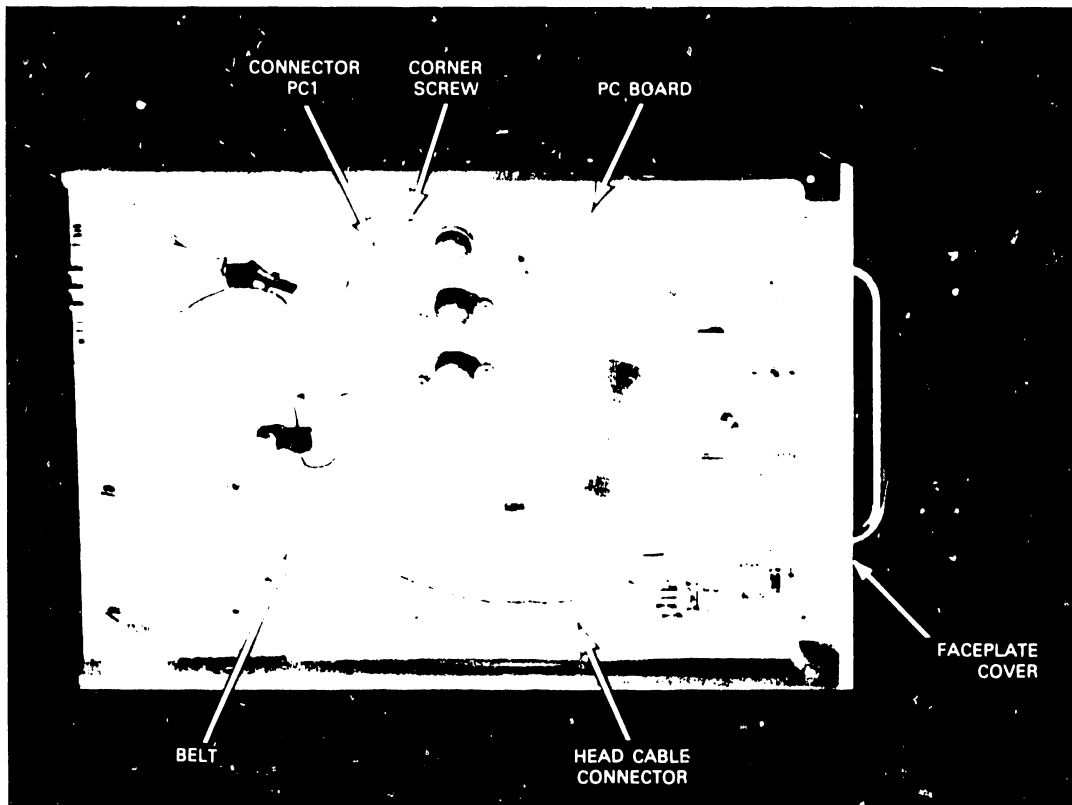

FIGURE 1 INTERFACE ELECTRONICS

In Figure 2 the track positioning actuator and lead screw positions the Read/Write head to the desired track on the disk. The head load actuator loads the disk against the Read/Write head and data may then be recorded or read from the disk.

The disk drive motor rotates the spindle at 375 RPM through a belt-drive system. 50 or 60 Hz power is accommodated by means of a stepped pulley. A registration hub, centered on the face of the spindle, positions the disk. A clamp (that moves in conjunction with the insertion door) fixes the disk to the registration hub.



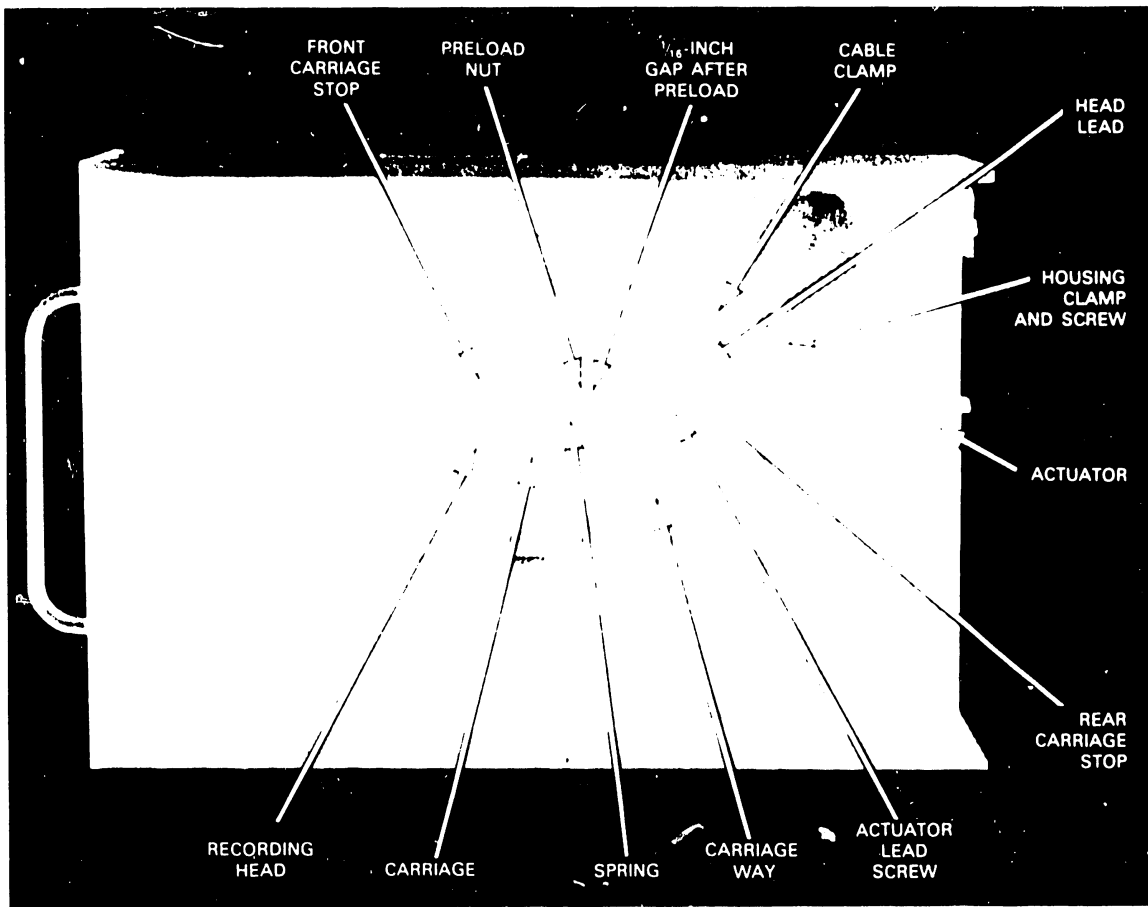

FIGURE 2

The Read/Write head is mounted on a carriage that is moved by the lead screw. As shown in Figure 3, head load is achieved when the disk is lightly loaded against the rigidly mounted head by energizing a solenoid. This releases the bail from the spring-loaded carriage load arm and causes the load arm pad to press against the head. Deenergizing the solenoid causes the retracting bail to lift the load pad from the disk thereby unloading the disk.

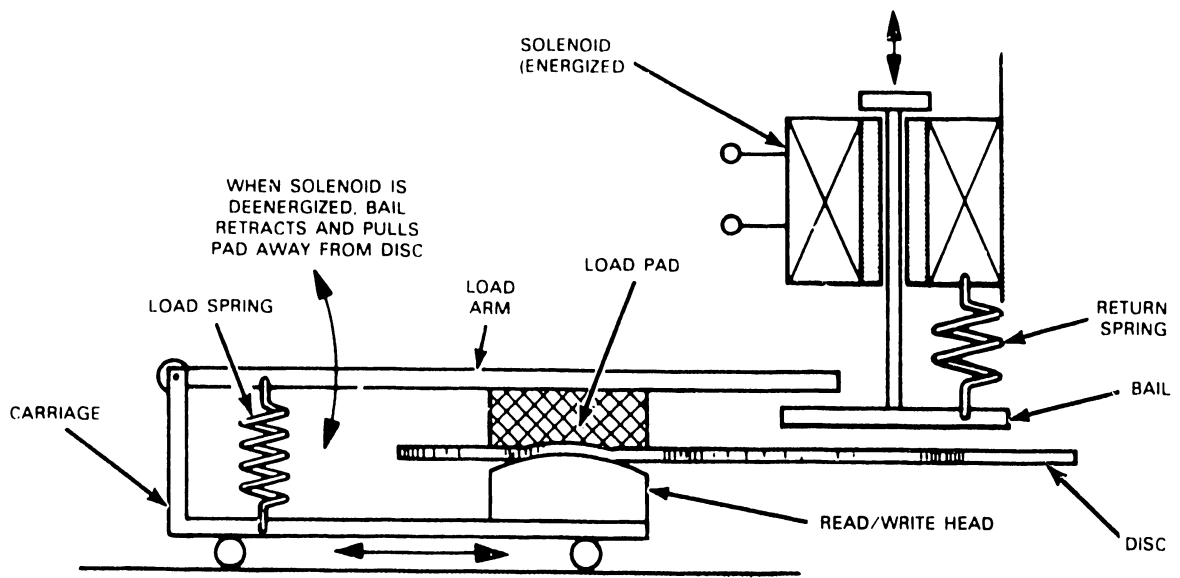

FIGURE 3

### 1.3.2 Wang Portion

Figure 4 is a top view of the Model 40. Facing the unit, the component side of the PC boards is to the left except for the 352 regulator board which faces to the right.

Figure 5 shows the PROM layout and part numbers for the various units and capacities. When changing the storage capacity of a unit, the only change that has to be made is the change of PROMs.

**NOTE:**

Figure 5 illustrates PROM loading only and not conversion procedures from 640, 740, or 2240. See Appendix D for conversion procedures.

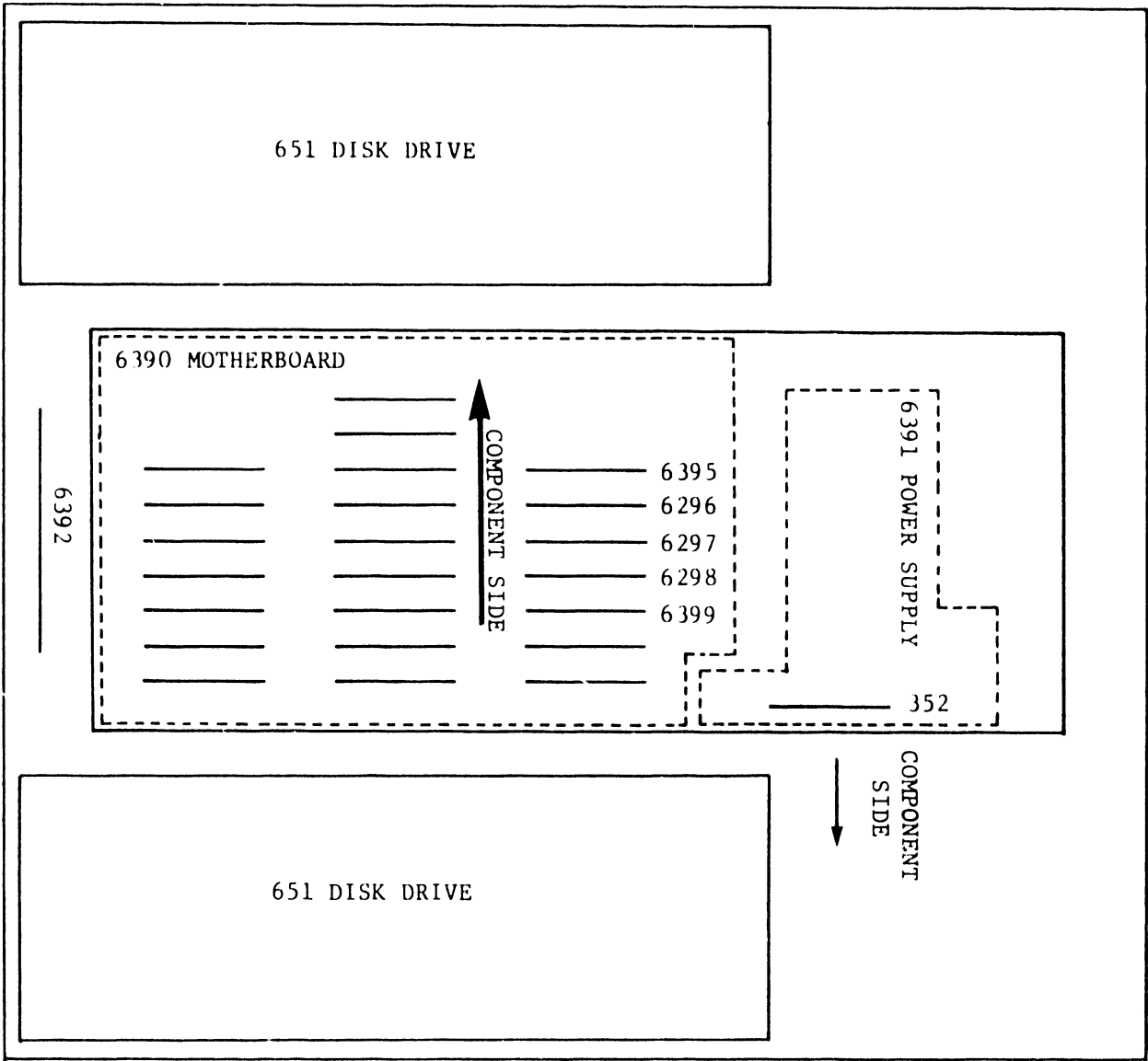

FIGURE 4

	L1	L3	L4	L5	L7	L8
640-1		378-0227	378-0229R2		378-0228	378-0230R2
640-2		378-0231	378-0233R2		378-0232	378-0234R2
740-1	378-0218R2	378-0214	378-0216	378-0219R2	378-0215	378-0217R1
740-2	378-0224R2	378-0220	378-0222	378-0225R2	378-0221	378-0223R1
2240-1		378-0235	378-0237R1		378-0236	378-0238R1
2240-2		378-0239	378-0241R1		378-0240	378-0242R1

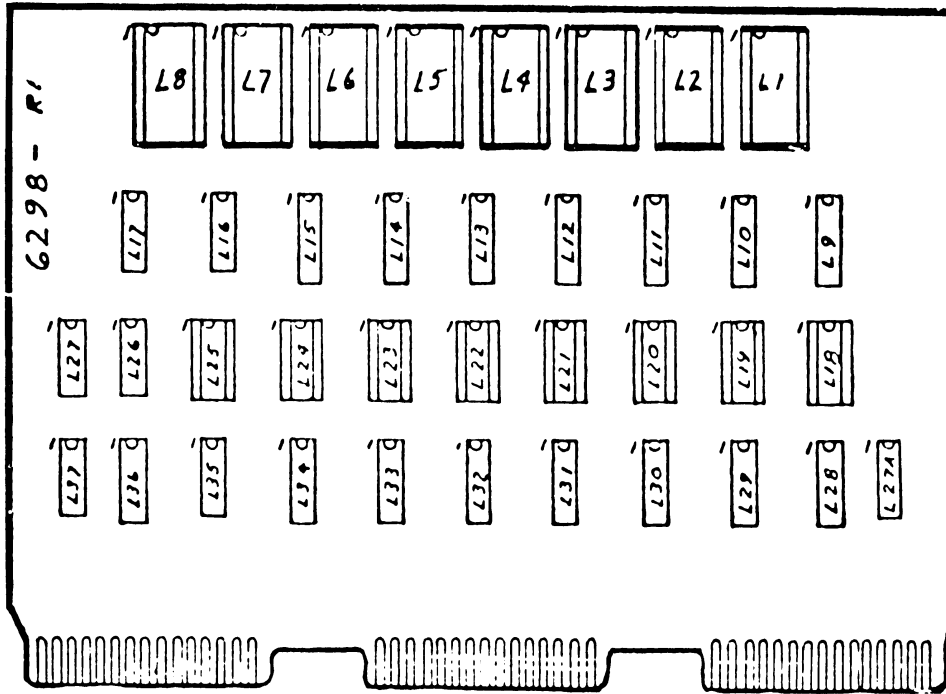

FIGURE 5 PROM LOADING

#### Voltage Checks - 352 Regulator

There are four voltages that should be checked, three being adjustable on the 352 regulator board. Measure all voltages with respect to  $\pm 0V$  on pin C or 3 of the 352 card.

	VOLTAGE	POT	352 PIN NO.
1.	+5	R3(Top right)	B or 2
2.	+24	R10(Top left)	H or 7
3.	-13.5	R13(Bottom right)	A or 1

The fourth voltage is -9.5V which should be measured on pin 24 of a PROM on the 6298.

### 1.3.3 FD/IV Flexible Disk Cartridge

#### 1) General (See Figure 6)

The Model 40 can write and read disks interchangeably from unit to unit. The FD/IV Flexible Disk Cartridges used in the Model 40 are flat disks composed of polyester substrate coated with a magnetic oxide and are approximately 7 1/2" (19.05 cm) in diameter. For protection during handling, operation, storage and mailing, the coated disks are encased in a flexible vinyl envelope, eight inches square by one sixteenth inch thick, which is sealed around the edges of the disk and lined with a self-cleaning wiper. An oval slot in the envelope permits the Read/Write head to access the disk for recording. Only one side of the cartridge is used for recording.

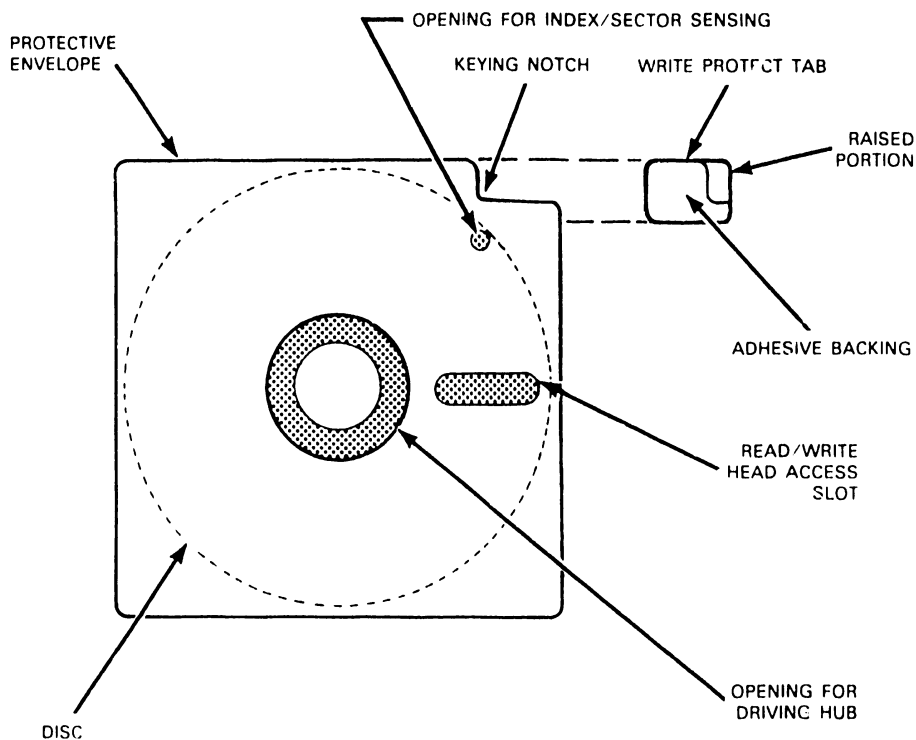

FIGURE 6  
FD/IV FLEXIBLE DISK CARTRIDGE

Formatting and writing on the disk can be inhibited by sliding a fitted one inch by three fourths inch adhesive-backed write protect tab into the keying notch of the vinyl envelope containing the disk. When this removable plastic tab is in position and the disk is inserted in the 651 drive, the raised portion of the tab pushes the actuator which closes the write protect switch. Once the switch is OFF (closed), the file is protected. The full Read/Write capabilities can be restored by physically removing the write protect tab.

2) Design and Utilization (See Figure 7)

There is only one recordable surface on each disk platter. The proper surface is accessed when the platter is loaded into the disk drive correctly.

Each surface of a disk contains 32 or 64 tracks depending on the capacity of the unit. The tracks are numbered from the outside inward starting with track 0. Each track has a capacity of 4096 bytes. The table below summarizes tracks and total bytes.

MODEL	DISK	TRACKS	TOTAL TRACKS	TOTAL BYTES
40-1	LEFT	32	64	262,144
	RIGHT	32		
40-2	LEFT	64	128	524,288
	RIGHT	64		

In the 740-1 unit, the addresses begin at track 0 of the left disk until track 32 is reached, then they proceed to track 0 of the right side.

In the 740-2 unit, the addresses begin at track 0 of the left disk until track 31 is reached, then they proceed to track 0 of the right disk. When track 31 of the right disk is filled, track 32 of the left disk is used until track 63 is encountered. The addresses continue to track 32 of the right disk until track 63 is reached.

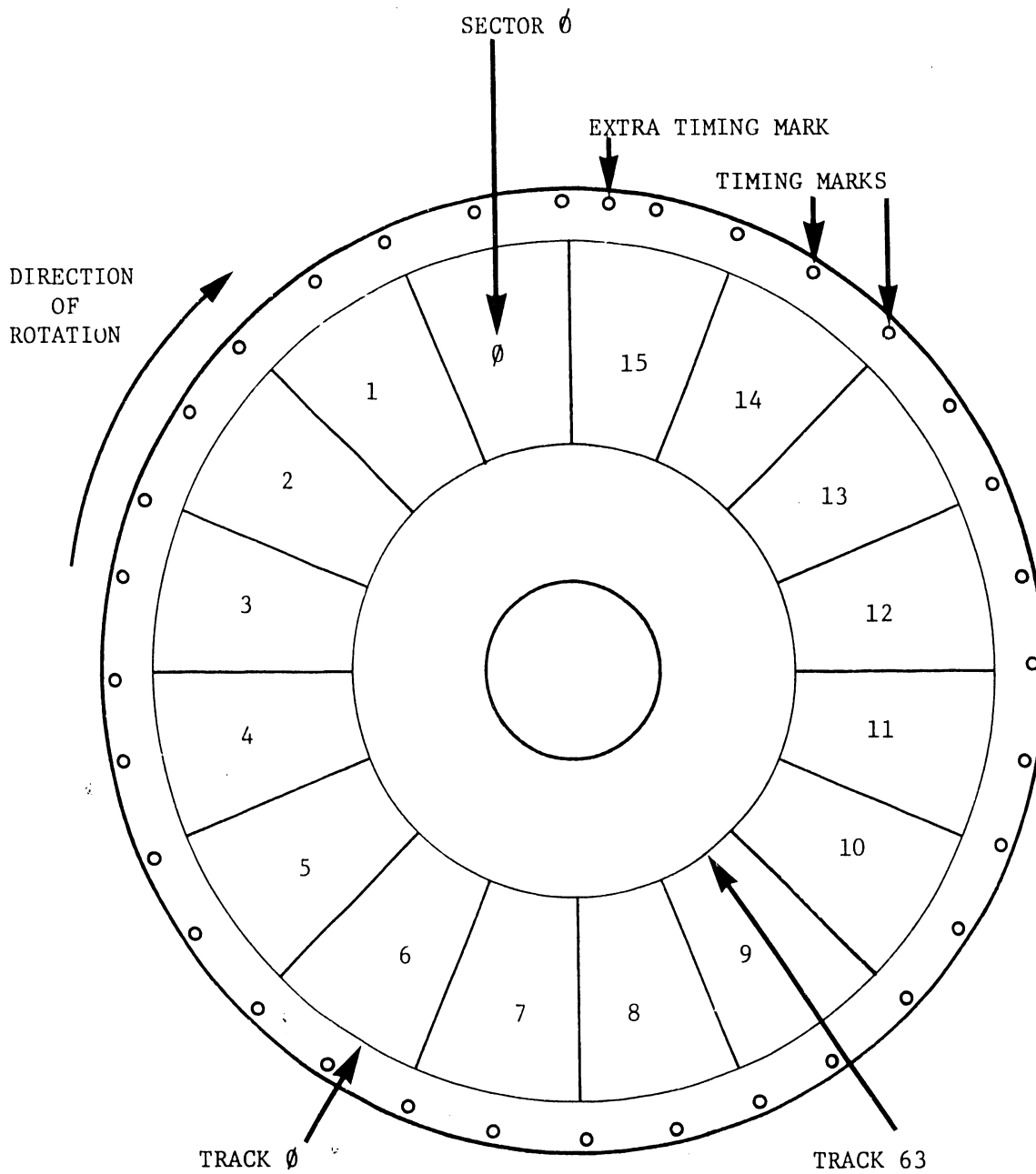

FIGURE 7  
DISK DESIGN AND UTILIZATION

The 640 addresses begin on the left disk and continue to the right disk regardless of capacity.

The 2240 addresses are identical on both the left and right disks regardless of capacity.

Each track is divided into 16 sectors each containing 256 bytes. Each sector is found by the unit using the timing marks as guides. Every other timing mark constitutes a sector.

3) Cyclic Redundancy Check

When data is recorded on the disk, two additional bytes are automatically written by the controller at the end of each sector. On a READ command, these bytes are transferred into the controller and verify the fact that a correct READ took place. This is called a Cyclic Redundancy Check (CRC).

4) How Data Is Written On A Disk

The Model 40 Writes and Reads 256 bytes at one time. The 640 and 2240 addresses are entire sectors. The 740 is capable of writing and reading the following number of bytes: 1, 8, 16, 32, 64, 128, and 256. When using a 740, special attention must be paid to transferring data efficiently.

In a 700/740 system, when a WRITE command is executed, the controller writes 256 bytes, starting at the beginning of a sector, despite the amount of bytes specified in the WRITE command and address issued by the operator. For an operator to WRITE data most efficiently, the operator should use WRITE 256 commands at an address which is a multiple of 256. The following examples explain what happens when a WRITE command is issued, and why a WRITE 256 at a sector address is fastest.



Example 1: WRITE 128 at Address 520

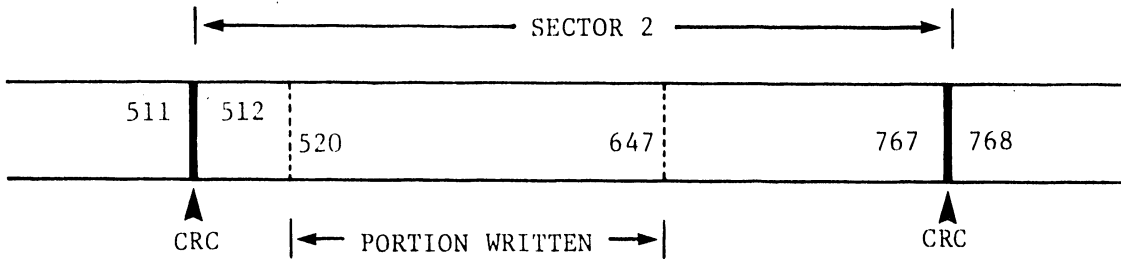

- (a) First, the system determines on what track and in what sector the starting address is located and moves the READ/WRITE head to the beginning of that sector.
- (b) The READ/WRITE head then reads the entire sector, byte for byte, into a buffer of 256 bytes. In the buffer, the bytes are manipulated and the specified bytes (i.e., 520-647) are stored with the other bytes remaining unchanged.
- (c) The buffer is then written into sector 2.
- (d) The reason the entire sector is read into the buffer is due to the CRC. The CRC is calculated only for each sector and only when the sector is written. Therefore, to have an up-to-date CRC, the CRC must be recalculated each time any of the bytes in the sector are changed. By reading the entire sector into the buffer, and then rewriting it back onto the disk, the controller, in effect, is writing the entire sector from scratch and calculates the new CRC. There is no way for the controller to update a CRC for only a portion of a sector without the controller rewriting the entire sector.

Example 2: WRITE 128 at Address 650

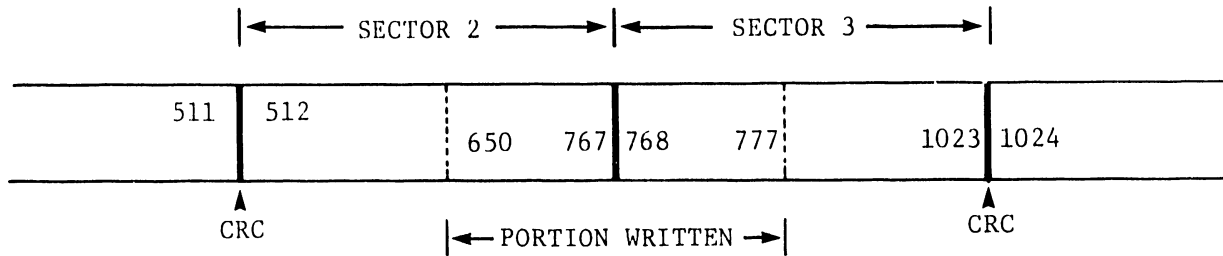

The procedure described for example 1 is identical for example 2, except two sectors (2 and 3) are read into a buffer of 512 bytes. The WRITE command involves bytes which overlap from one sector to the next. Therefore, each sector CRC must be updated.

Example 3: WRITE 256 at Address 512

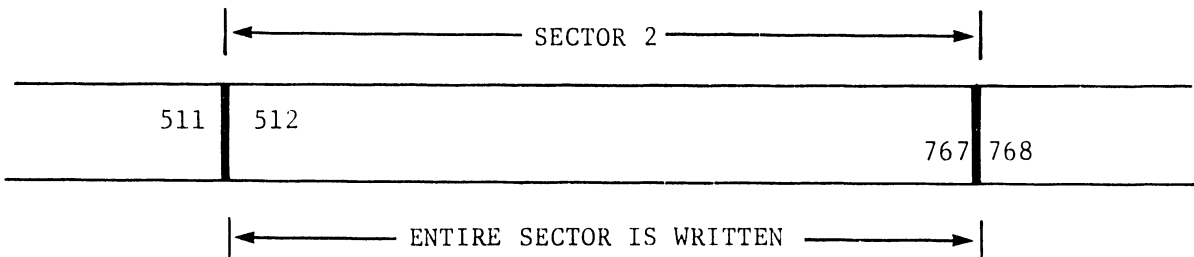

The procedure is not the same in this example as it was in examples 1 and 2. The READ before WRITE is eliminated. The information written goes directly from the buffer onto the disk because address 512 is a multiple of 256. Therefore, the CRC can be calculated as the sector is written the first time the sector passes under the READ/WRITE head.

In examples 1 and 2 the sector had to pass under the READ/WRITE head twice; once in order to read the sector into the buffer (first rotation) and once to write it back onto the disk (second rotation). A WRITE 256 at a sector address (multiple of 256) is the most efficient means of writing data, as no extra rotations of the disk are required.

## 2. MODEL 40 INSTALLATION

The Model 40 is shipped in one box with two disk packs included. Remove the unit from its box and remove the six screws holding the cover in place; remove the cover. Next remove the six screws holding the front panels in place; slide the front panel to the right and pull out.

**CAUTION:**

Do not open the drive doors to remove the front panel. Damage to the head load bails may result.

When removing the front panel, insure that the control panel does not fall forward, for it is modular and held in place by the front panel. Disconnect the two ribbon cable connectors, one of which plugs into the controller motherboard, the other into the front control panel; remove the control panel. This will give easy access to the right drive PCB test points. At this point, remove the two plexiglass covers protecting the drive mechanics by pulling them forward. Now remove the tape restraining the head load bail of each drive, being careful not to dislocate the bail.

**NOTE:**

The disk cartridges must be installed to perform the checks (tolerances). See Section 3.2.

There are two adjustments that must be checked before operating the Model 40. First, the gap between the actuator bail and the actuator solenoid, and second, the gap between the actuator bail and the load arm tab. To check these adjustments, the left drive must be removed

because the areas to be checked are inaccessible with the drive in the unit. The left drive is held in place by four 3/8" bolts on the bottom of the unit. Removal of the drive can be accomplished by sliding the unit over the edge of the surface on which it is setting to allow access to the bolts.

A gap between the actuator bail and the actuator solenoid should be .030" (.076 cm) measured at point A in Figure 8 (this can be done with power off). Should this need adjustment, it is accomplished by forming the tab D shown in Figure 8. By moving this tab away from the solenoid bracket in direction F, the bail is moved closer to the solenoid likewise by moving it closer to the solenoid bracket in direction E, the bail is moved away from the solenoid.

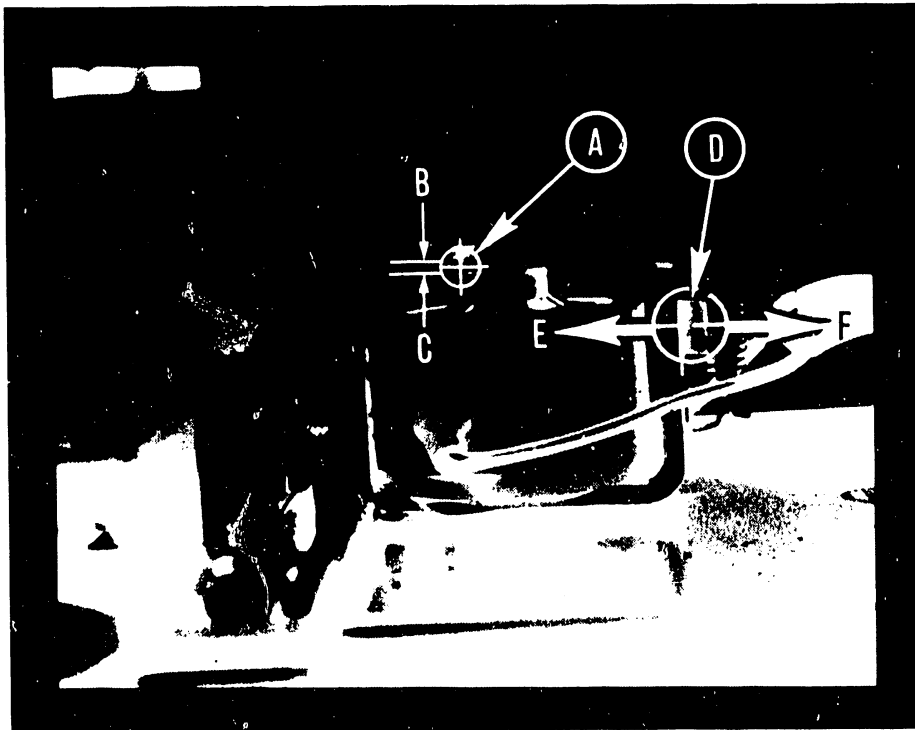

FIGURE 8

Next connect a jumper wire from test point 28 located near the center of the 22 pin connector of the PC board to ground, test point 23 (See Figure 10 for Test Points). Apply power to the unit; the power switch is located on the rear of the unit next to the fuses. The gap between the actuator bail and the load arm tab should be  $.015" \pm .005"$  ( $.038 \text{ cm} \pm .013 \text{ cm}$ ), points A and B in Figure 8A. Should this need adjustment, it is accomplished by loosening the bail adjustment screw and moving the bail closer or further from the load arm tab. Insure that the gap remains the same from one end of the bail to the other.

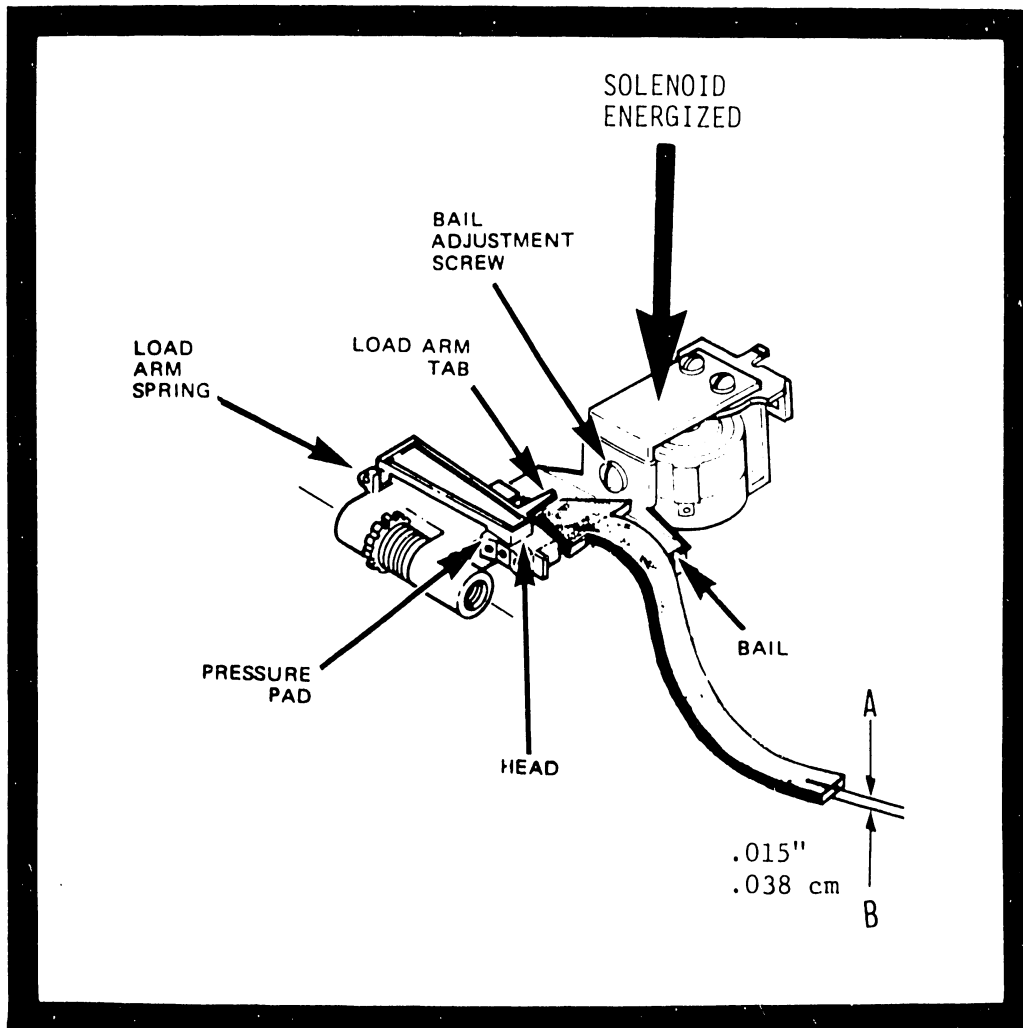

FIGURE 8A

Access track 63 (or 31 if a 40-1 unit) and again check the gap,  $.015" \pm .005"$  ( $.038 \text{ cm} \pm .013 \text{ cm}$ ), to insure that the bail is parallel to the disk surface.

NOTE:

Return heads to the retracted position after adjustments or the unit will not be able to be selected.

These adjustments are essential because they determine: how much pressure the cartridges apply to the read/write heads and, the correct clearance for installing and removing the cartridges from the unit.

Head radial alignments and index alignments will be checked upon installation when a Field Service Alignment Cartridge is available for field servicemen. Both drives must be removed to do these alignments. (See Section 5.)

The control panel and front panel should be installed after the adjustments are made on the head load bail and solenoid.

### 3. OPERATION

#### 3.1 INDICATOR LIGHTS AND SWITCHES

The control panel for the Model 640 and 740 incorporate five indicator lights, five toggle switches, one push button switch and a keylock switch.

- 1) POWER - A lamp that illuminates when the power switch on the rear of the unit is turned on.
- 2) ERROR - Informs operator of several types of errors:
  - (a) *Flashing* - Indicates an illegal address given to the disk unit.
  - (b) *On* - Indicates either an incorrect read due to the CRC or the disk cannot locate the address requested.
- 3) LEFT DISC - Illuminates when the left disk is selected.
- 4) RIGHT DISC - Illuminates when the right disk is selected.
- 5) MANUAL LEFT/RIGHT - Switch used to select a disk when formatting.
- 6) GROUP ADDRESS - Used to select the unit for transfer of data. When all down they equal 00, all up equal 15. (Not used on 2240)
- 7) LOCK/ON - When in the lock position, no formatting is possible; on allows formatting.
- 8) FORMAT SWITCH - When depressed, with the key in the on position, initiates formatting of a disk.
- 9) FORMAT INDICATOR - Illuminates when either disk is being formatted. Flashes when disk is used for transfer while the format key is on.

### 3.2 LOADING AND HANDLING OF DISK CARTRIDGES

A disk cartridge should be handled carefully when being inserted or removed from the Model 40. The following paragraphs give procedures necessary for insertion of a disk cartridge into the drive and for cartridge handling.

The cartridge consists of a flexible disk encased in a plastic jacket. Wipe cushions are bonded to the inside of the jacket. The disk is housed and rotates between these cushions during normal operation. Figure 9 shows how the cartridge is inserted in the cartridge guide. This is accomplished by opening the door, inserting the cartridge into the cartridge guide and closing the door. The cartridge may be loaded or unloaded with power on or off. When removed from the drive, the cartridge should be stored in a plastic coated envelope. To protect the cartridge, follow these precautions:

- 1) Return the cartridge to its storage envelope whenever it is removed from the Model 40.
- 2) Store cartridges vertically.
- 3) Keep cartridges away from magnetic fields; strong magnetic fields can destroy recorded data on the disk.
- 4) Replace storage envelopes when they become worn; envelopes are designed to protect the disk.

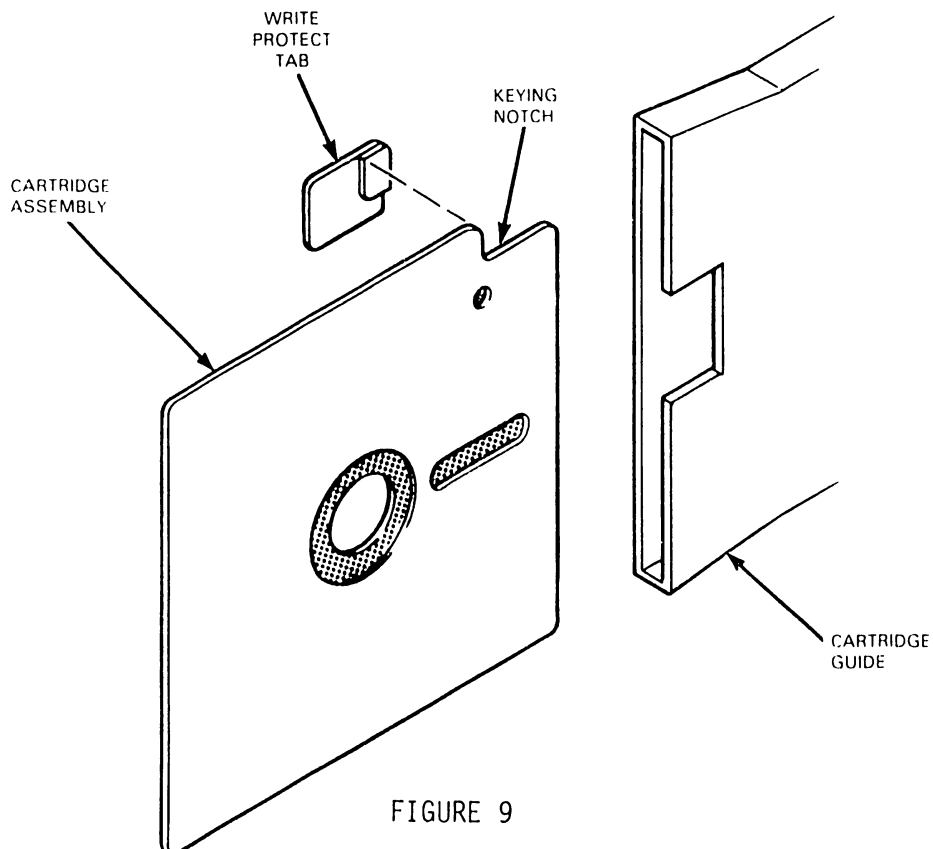

FIGURE 9



- 5) Do not write on the plastic cartridge with a lead pencil or ball point pen; use a felt tip pen.
- 6) Do not smoke while handling cartridges. Heat and contamination from a carelessly dropped ash can damage a disk.
- 7) Do not expose cartridge to heat or sunlight. The Read/Write head cannot properly track a warped disk.
- 8) Do not touch or attempt to clean the disk surface. Abrasions may cause loss of recorded data.

### 3.3 DISK FORMATTING

Whenever a new disk is loaded into the disk unit, the new disk must be formatted. Also, if an old disk is causing Read/Write errors, the problem can sometimes be corrected by reformatting the disk. Every disk must be formatted at least once. The formatting procedure results in the automatic recording of addresses on the disk which enables the disk controller to locate information on the disk for reading and writing purposes.

- 1) Turn the format key located on the front panel of the disk unit to the ON position.
- 2) Select which disk is to be formatted (i.e., right or left) by pushing the manual switch to right or left. The left or right disk light comes on indicating which disk is to be formatted.

**NOTE:**

The only time the manual switch is used is during the formatting procedures.

- 3) Push the format switch. Formatting begins immediately, signaled by the format indicator light illuminating. The format indicator light goes off when formatting is complete.

NOTE:

It takes approximately 40 seconds to format a disk if the first attempt is successful. The 740 and 2240 automatically try to format a disk four times. Should the format light remain on for more than three minutes, the system has been unsuccessful in formatting a disk. The error light also illuminates. Repeat the procedure again from step 1, check that the disk drive door is properly closed by opening and closing it again, and/or try another disk platter.

- 4) When the format indicator light goes off, turn the format key to LOCK. The 740 and 2240 automatically check the format before turning off the format light.
- 5) Repeat this procedure from step 1 for the other disk.
- 6) Once both or all disks are formatted, the Model 40 is ready to use.

### 3.4 MODEL 740 OPERATION

#### 3.4.1 *Disk Selection*

The 740 must be selected by a 700C or 720C calculator before it can be used. The disk is addressed by a two-step command:

GROUP 2    00XX

where on the 700 keyboard, GROUP 2 is a key, 00 is all toggle switches down and XX is one of the function keys 00 through 15. The XX must match the setting of the group address switches on the 740. The 740 remains selected until it is turned off or another high speed device is selected (GROUP 2 00XX).

### 3.4.2 Disk Addresses

MODEL	LEFT DISK ADDRESSES	RIGHT DISK ADDRESSES	TOTAL BYTES
740-1	0-131071	131072-262143	262,144
740-2	0-131071 262144-393215	131072-262143 393216-524287	524,288

The above table provides the legal addresses for the 740. A transfer command that begins on one disk and ends on the other is not possible; since this is illegal, the disk error light flashes.

EXAMPLE: When an attempt is made to WRITE 8 bytes beginning at address 131070, an error occurs because the 740 is unable to complete a transfer command utilizing both disks.

### 3.4.3 Data Transfer

The following table lists the transfer commands available in the 740:

COMMAND	CODE	FUNCTION
READ 1	0800	Transfers 1 byte from disk to 700.
READ 8	0801	Transfers 8 bytes from disk to 700.
READ 16	0802	Transfers 16 bytes from disk to 700.
READ 32	0803	Transfers 32 bytes from disk to 700.
READ 64	0804	Transfers 64 bytes from disk to 700.
READ 128	0805	Transfers 128 bytes from disk to 700.
READ 256	0806	Transfers 256 bytes from disk to 700.
WRITE 1	0808	Transfers 1 byte from 700 to disk.
WRITE 8	0809	Transfers 8 bytes from 700 to disk.
WRITE 16	0810	Transfers 16 bytes from 700 to disk.
WRITE 32	0811	Transfers 32 bytes from 700 to disk.
WRITE 64	0812	Transfers 64 bytes from 700 to disk.
WRITE 128	0813	Transfers 128 bytes from 700 to disk.
WRITE 256	0814	Transfers 256 bytes from 700 to disk.

Prior to using one of the transfer commands, place the starting address of the disk in the Y display and the step number where transfer is to begin in the calculator in the X display.

### 3.5 MODEL 640 OPERATION

#### 3.5.1 *Disk Selection*

The 640 must be selected before it can be used. The disk is addressed by a two-step command:

GROUP 2 00XX

where on the 600 keyboard, GROUP 2 is a key, 00 is all function switches up and XX is one of the register keys 00 through 15. The XX must match the setting of the group address switches.

#### 3.5.2 *Disk Addresses*

The table below provides the legal addresses for the 640. Unlike the 740, the 640 only transfers a block of 256 bytes.

MODEL	LEFT DISK ADDRESSES	RIGHT DISK ADDRESSES	TOTAL BYTES
640-1	0-511	1048576-1049087	262,144
640-2	0-1023	1048576-1049599	524,288

### 3.5.3 Data Transfer

Data is transferred in blocks of 256 bytes. There are five read/write functions.

COMMAND	CODE	FUNCTION
WRITE 256	I/O 1314	Transfers 256 steps from calculator to disk.
READ 256	I/O 1306	Transfers 256 steps from disk to calculator.
COMPARE 256	I/O 1314	Compares one block on the disk with one block of 256 steps in the calculator.
WRITE 1	I/O 1308	Transfers one step from the calculator to the disk controller.
READ 1	I/O 1300	Transfers one step from the disk controller to the calculator.

To read or write information, store the disk address in register 00 of the 600 and the step number where transfer is to begin in the 600 in register 01.

The COMPARE 256 command compares the contents of one block of the disk with one block of 256 steps in the 600. This is the same code as WRITE 256, but the number 8,388,608 must be added to register 00 in the 600 to signify to the disk that this is a compare command.

The primary purpose of the COMPARE 256 command is to allow the programmer to immediately check that data has been correctly written onto the disk.

### 3.6 MODEL 2240 OPERATION

Because of the complexity of manually operating the 2240, an operation section is not included. Refer to the *2240 Reference Manual*.

## 4. MODEL 40 DIAGNOSTICS

### 4.1 MODEL 740 DIAGNOSTICS

Prior to running the diagnostics, format each disk. If the disks can be formatted, a large portion of the unit is good since the 740 has written and read its format.

The 740 diagnostic tape consists of three blocks with verifies of 2895, 2415 and 10985. The first two blocks are Data Checks in that they write all ones and zeros on every address of both disks. The third block is a Random Data Test that exercises the mechanical portions of the 740.

#### 1) Data Check (Verifies 2895, 2415)

The Data Check programs write and read 1515s (first block, 2895) and 0000s (second block, 2415) on any number of tracks keyed in by the operator, beginning with track 0. The two programs check the integrity of both disk cartridges.

Beginning with track 0, the programs first write all information in 256 byte transfers up to the number of tracks entered. The programs then read all information, previously written, in 256 byte transfers. After each read, the calculator compares the data that was read with the data that was written. The approximate running time for a 740-1 is eight minutes.

NOTE:

Any data pattern can be used. Program steps 32 - 47 inclusive contain the data pattern. Anytime the data pattern is changed, the verify changes, and, the program must be restarted.

Equipment Needed:

700C or 720C

740-1 or 740-2

Operating Instructions:

- (a) Set address switches on 740 to 0000.
- (b) Prime, Load Program, Verify 2895 or 2415, Prime.
- (c) Enter 1 if 700C, 2 if 720C, Go.
- (d) Enter number of tracks to be checked:
  - (1) If entire 740- to be checked, key 64, Go.
  - (2) If entire 740-2 to be checked, key 128, Go.
  - (3) Any number can be entered provided it does not exceed the number of tracks in the unit.
- (e) When the test is successful, the calculator stops at program step 240 with X+1 displayed in both registers. (X= the last address of the number of tracks entered in step (d).)
- (f) Calculator stops at step 243 if test fails.

2) Random Data Test (Verify 10985)

The 740 Random Data Test randomly selects addresses on either disk, and writes and reads data keyed in by the operator. The random address selection is dependent on the random number used for data transfer. The test also checks all the read/write commands.

Equipment Needed:

720C

Output Writer (701, 702, 711, 721)

740-1 or 740-2

Operating Instructions:

- (a) Set address switches on 740 to 0000.
- (b) Turn on or select output writer as program does not perform this function.
- (c) Prime, Load Program, Verify 10985, Prime.
- (d) Key 0000. Output writer prints out heading.
- (e) Key 740 capacity (1 or 2). GO.
- (f) Key a random number (any positive *integer* greater than 1). GO.
- (g) If hang up occurs, key search 0002. The X display contains the disk address that failed.
- (h) If errors on a read or write occur, the disk address will be printed out.



## 4.2 MODEL 640 DIAGNOSTICS

### 1) Format Check (Verify 559)

Since the 640 does not automatically check a disk cartridge after formatting, a format check should be run to check disk address integrity. The test only checks one disk at a time.

The program writes a block of 256 bytes at every location and then does a write compare. When the test is complete, the last address and the letter "G" is printed. If an error exists, the printer prints the address that failed with the letter "E" indicating an error at that location. Registers used: 00, 01, 02. Approximate running time is six (6) minutes per disk.

#### Operating Instructions:

- (a) Set address switches on 640 to 0000.
- (b) Prime, Load Program, Verify 559, Prime.
- (c) Turn printer on.
- (d) Key beginning and ending addresses of disk to be checked:
  - 640-1 Left: 0, Go, 511
  - 640-1 Right: 1048576, Go, 1049087
  - 640-2 Left: 0, Go, 1023
  - 640-2 Right: 1048576, Go, 1049599
- (e) If hang up occurs, Prime, Search 0. Faulty address will be displayed.

2) Random Data Test (Verify 2886)

The 640 Random Data Test should be run after the format check program has been run. The random test exercises the disk unit in that the addresses are randomly chosen. Data, keyed in by the operator, is written into buffer 1 (registers 16-47), written on the disk, read into buffer 2 (registers 48-79), and compared.

Operating Instructions:

- (a) Set address switches on 640 to 0000.
- (b) Prime, Load Program, Verify 2886, Prime.
- (c) Turn printer on.
- (d) Key Search 0. Clear display results. If "640" appears in the display and keyboard locked, unit cannot be selected.
- (e) Key in unit capacity (1 or 2). GO. Printer prints capacity and letter "M".
- (f) Key the number of writes and reads desired at each address. GO. Printer prints number and letter "I".
- (g) Key the data to be transferred (any positive number larger than 1). Printer prints the number with the letter "J".
- (h) Enter a number which will cause a printout for that number of writes and reads. (If 100 is entered, the printer will print out the amount of writes and reads in 100 intervals.) GO.
- (i) Test continues to run until stopped. If the 600 hangs up, Prime, Search, Search.

Print-Out Messages:

(a) Write Error

When a write error occurs, the printer prints the disk address with the letter "X".

(b) Read Error

When a read error occurs, the printer prints the disk address with the letter "Z".

(c) Compare Error

When a compare error occurs, the printer prints the following:

XXXX A (Beginning register number in the 600 that was used for the compare.)

XXXX B (Incorrect data)

XXXX A (Disk address that did not compare)

XXXX B (Original data)

(d) Hang-Up Error

After search, search, the printer prints one of the following:

XXXX X (Write malfunction)

XXXX Y (Compare malfunction)

XXXX Z (Read malfunction)

#### 4.3 MODEL 2240 DIAGNOSTICS

##### 1) 2240 Disk Hardware Diagnostic

###### Equipment Needed:

2200B-1 (4K memory minimum)

2216/2217

2215 or 2222

2240-1 or 2240-2

###### Operating Instructions:

- (a) Format the left and right disks.
- (b) CLEAR EXECUTE
- (c) LOAD EXECUTE
- (d) RUN EXECUTE
- (e) Key 1 for 2240-1 or 2 for 2240-2
- (f) Key Y or N for TEST #1
  - (Y for test #1)
  - (N skip test #1)

**NOTE:**

It is advisable to skip TEST #1 the first time running the diagnostic because of the time required to run TEST #1.

The program automatically loads the following programs:

- (a) TEST #1 (write at every sector address and read the information back to check for errors).
- (b) Testing DATA SAVE DA, DATALOAD DA from 1 to 10 variable.
- (c) ALPHANUMERIC VARIABLE

- (d) ALPHANUMERIC ARRAYS
- (e) Testing DATA SAVE BA, DATALOAD BA, using Numeric and Alpha-numeric sector addressing.
- (f) Read after write at random locations.

2) 2240 Disk Microcode Diagnostic

Equipment Needed:

2200B-1 (4K memory minimum)

2216/2217

2215 or 2222

2240-1 or -2

Operating Instructions:

- (a) FORMAT the left and the right disks.
- (B) CLEAR EXECUTE
- (c) LOAD EXECUTE
- (d) RUN EXECUTE
- (e) Enter 1, or 2 for a 2240-1 or -2.

The program automatically loads the following. Each program checks the operation of the 2240 for that BASIC INSTRUCTION.

- (a) DATA LOAD/DATA SAVE DC OPEN
- (b) DATA LOAD/DATA SAVE DC
- (c) DATA LOAD/DATA SAVE DA
- (d) DATA LOAD/DATA SAVE BA
- (e) D SKIP/D BACKSPACE
- (f) VERIFY
- (g) LIMITS
- (h) MOVE END

- (i) CATALOG INDEX
- (j) SCRATCH DISK
- (k) COPY
- (l) MOVE
- (m) DATA SAVE DC CLOSE
- (n) SCRATCH

## 5. MAINTENANCE

The maintenance procedures contained in this section are:

- 1) Head radial alignment check.
- 2) Head radial alignment procedure.
- 3) Index alignment check.
- 4) Index alignment procedure.
- 5) Carriage stop adjustment procedure.
- 6) Track 00 switch assembly adjustment procedure.

As of this writing, April, 1974, the 651 drives will be treated as tape drives. All repairs to the disk drives will be done at the Home Office. However, procedures 1 and 3 above, along with the gap between the actuator bail and the actuator solenoid, and the gap between the actuator bail and the load arm tab contained in section 2 should be checked on every service call.

The following tools and accessories are needed to perform all of the maintenance procedures.

- 1) Oscilloscope, two probes, ground lead.
- 2) A BNC to banana adapter (for external triggering).
- 3) Jumper wire with male banana on one end and an alligator clip on the other (for external triggering).
- 4) Jumper wire with alligator clips on both ends.
- 5) Phillips and common screwdrivers.
- 6) Feeler gauges.
- 7) Allen wrenches.
- 8) Alignment cartridge.
- 9) 3/8" hex driver.
- 10) Read Write adapter plug.

Remove the cable clamp on top of left drive. Remove both 651 drives from the unit by removing the eight bolts on the bottom of the units using the 3/8" hex driver. Remove both plexiglass protectors.

To determine that a drive is bad, the drives may be swapped in the unit by exchanging the I/O cables.

NOTE:

The Field Service Alignment Cartridge used for the alignment checks is not sectorized or formatted, therefore, when the disk is accessed, the display will go blank on the calculator until the unit does four retries. At this time, the heads will retract to track 0 then return to the track accessed and make another retry. The calculator will regain control but in an error condition. Since the stepping motor on a step out depends on sector to move, the head will retract with every index pulse.

The following maintenance procedures are written for the 740 and 640. Since the two units differ in addressing, the first addresses are for the 740 and the addresses in parenthesis are for the 640. In the procedures, numerous Read commands will be encountered. Perform the following for a Read:

- 1) 700 calculator read commands
  - (a) Key the disk address in the Y display
  - (b) Clear X
  - (c) Key any read command from 0801 - 0806
  
- 2) 600 calculator read command
  - (a) Store the disk address in register 00
  - (b) Clear register 01
  - (c) Key I/O, 1306

CAUTION:

When performing the following maintenance procedures, do not set a disk cartridge on a drive unit due to the heat produced by the drive.



## 5.1 HEAD RADIAL ALIGNMENT CHECK

**NOTE:**

Both 651 drive and Field Service alignment disk must be exposed to ambient room temperature for at least 20 minutes prior to performing alignment procedures.

- 1) Insert Field Service alignment cartridge into the cartridge guide.
- 2) Ground TP28 on PC board to load the head. (See Figure 10)

**CAUTION:**

Do not allow jumper to become entangled in drive belt.

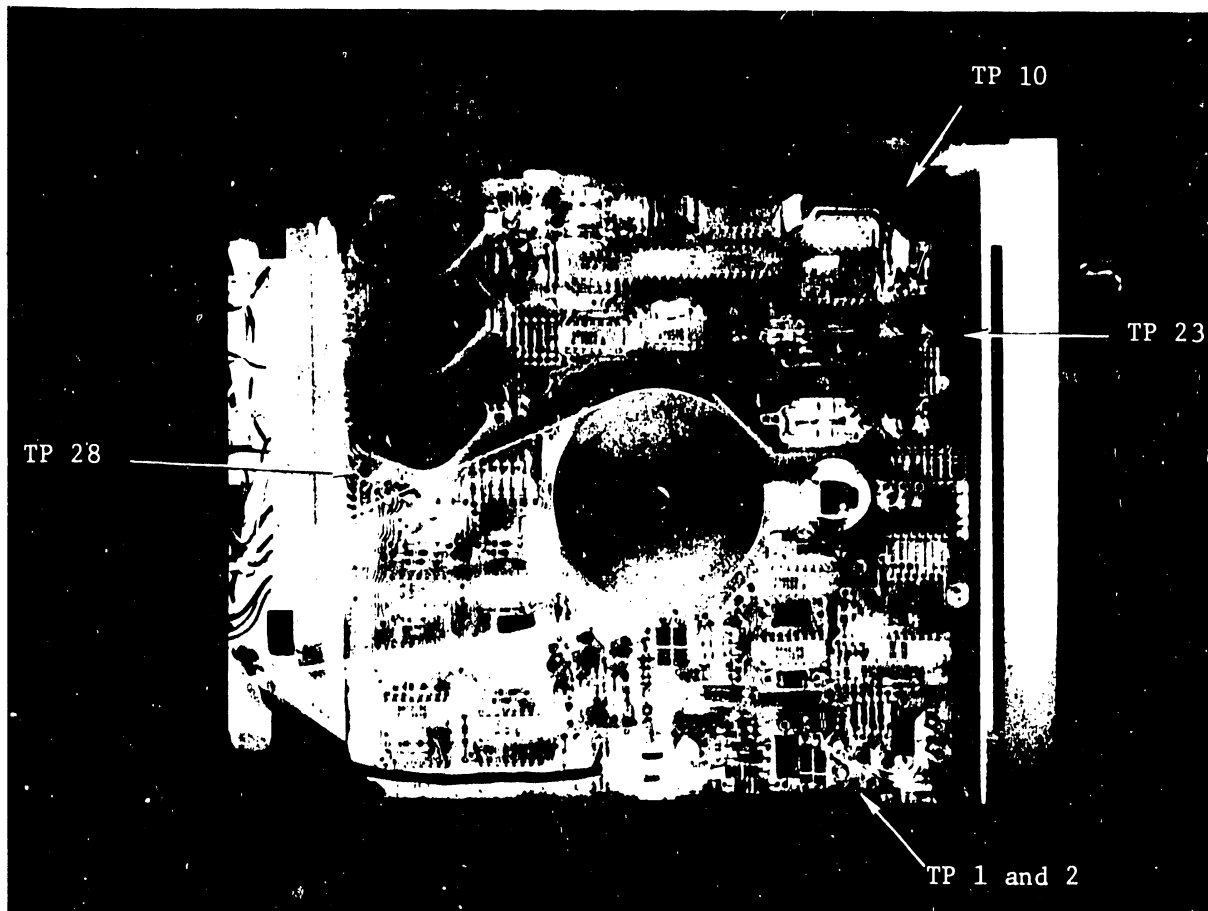

FIGURE 10 TEST POINTS

- 3) Connect oscilloscope probes to monitor test points TP1 and TP2 (head signals). Set oscilloscope to external sync, invert and add. Connect the banana-BNC adapter into the external sync input of the scope. Plug the banana jumper into the adapter and connect the other end on TP10. Set time base to 20 ms/division; set amplitude to 20 mv/division/AC; normal trigger; positive slope. Connect a ground from the scope to TP23.
- 4) Apply power to unit and select unit (Group II, 00XX). Access track 31 by keying 258048 (1049072) for the right drive or 126976 (496) for the left drive doing a Read.

NOTE:

An alignment pattern as pictured in Figure 11 is recorded on alignment disk track 31. The oscilloscope should now display a signal envelope.

- 5) Compare amplitudes of two adjacent oscilloscope displayed lobes (Figure 11). They must be equal within 25% ( $3/4$  of a division). If they are, perform index alignment check (Section 5.3.2).
- 6) *If amplitudes are not specified in step 5, perform head radial alignment (Section 5.2).*

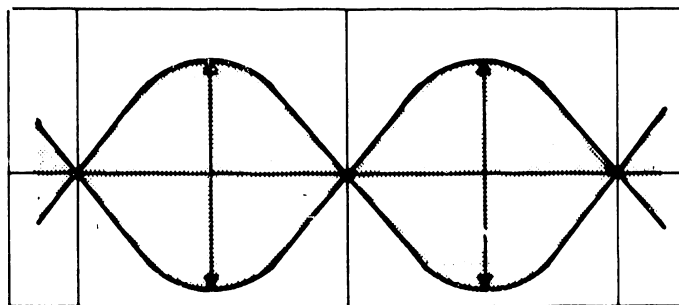

FIGURE 11

## 5.2 HEAD RADIAL ALIGNMENT PROCEDURE

- 1) Perform steps 1, 2, 3 and 4 of the Head Radial Alignment Check if not already done.
- 2) Loosen three screws in head position actuator housing-to-baseplate clamps sufficiently to permit housing rotation (Figure 12)

**WARNING:**

The head position actuator is operating at a temperature of 175°F (65°C). Do not grasp housing with unprotected hand.

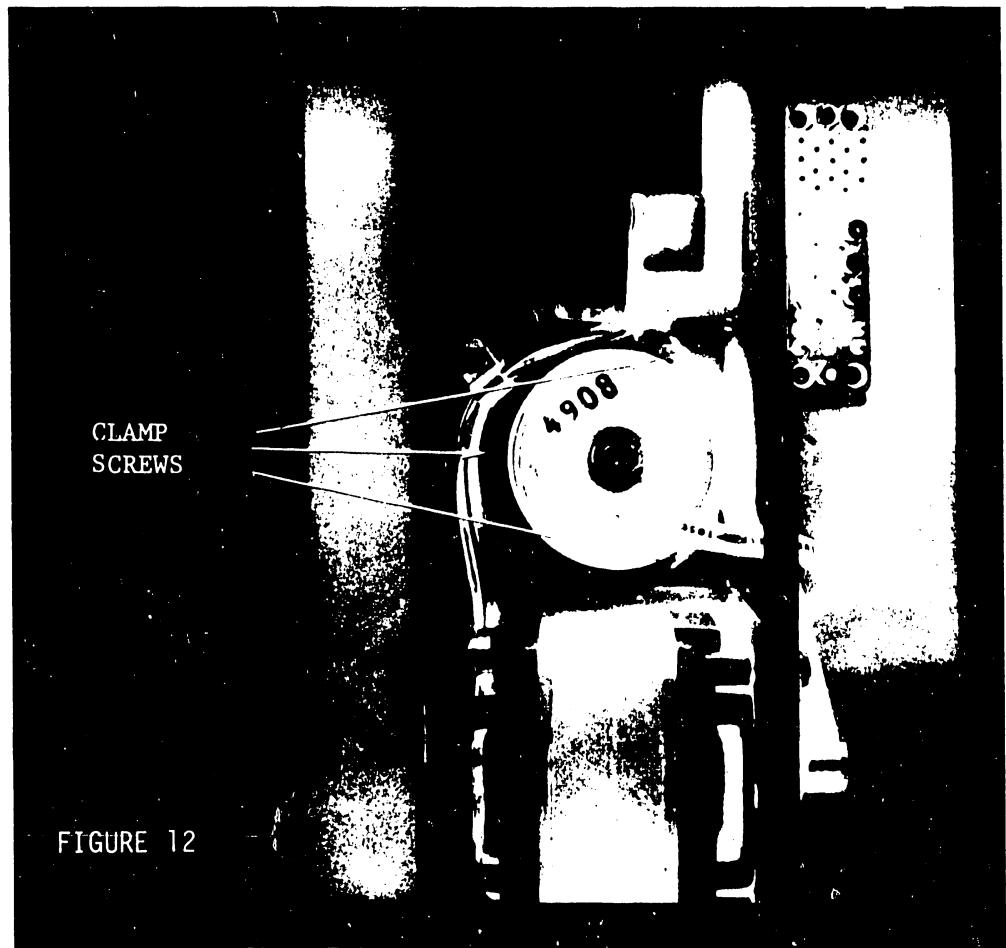

FIGURE 12

- 3) Rotate actuator housing until oscilloscope displays distinct lobe patterns, and then adjust housing radial position until two adjacent lobes are equal in amplitude. See Figure 11.
- 4) Retighten clamp screws without disturbing alignment.
- 5) Prime, and then reaccess track 31, 258048 (1049072) for the right drive, 126976 (496) for the left drive.
- 6) Compare amplitudes of two adjacent lobes. They must equal within 15%, if not, repeat steps 2, 3, and 4.

NOTE:

The 15% tolerance in this step is deliberately tighter than the 25% tolerance specified in step 5 of the Head Radial Alignment Check. The 25% tolerance makes allowance for the alignment having been set with a different Field Service alignment cartridge.

- 7) Disconnect and remove test equipment.

## 5.3 INDEX AND SECTOR SENSING COMPONENTS

### 5.3.1 *Description*

These components consist of the light emitting diode assembly, mounted on the front of the cartridge guide, and the phototransistor assembly, mounted behind the cartridge guide. The line of sight connecting these two components is perpendicular to the plane of the disk, and intersects the disk at the circle formed by the thirty-two sector holes and the index hole. When the disk is rotating, invisible infrared light emission from the light emitting diode actuates the phototransistor, which generates a 5 volt pulse, each time one of the .10" diameter holes in the disk exposes the phototransistor to the light emitting diode. An adjusting screw on the phototransistor assembly permits positioning the phototransistor along the arc of the disk holes so that the leading edge of the index/sector pulse occurs simultaneously with coincidence of the recording head and the geometric index or sector radius on the disk. This will assure that the leading edge of the sector pulse will occur simultaneously with the beginning of the physical sector.

NOTE:

A 6298-2 is needed to do this alignment.

### 5.3.2 *Index Alignment Check*

- 1) Perform Head Radial Alignment Check if not already done.
- 2) Connect oscilloscope as in Head Radial Alignment Check except: set time base to 20  $\mu$ s/cm and 50 mv/division.
- 3) Disconnect head cable connect from PC board and insert R/W adaptor plug in its place. Connect head cable connector to adaptor plug.

- 4) Access track 07 address 159744 (1048688) for right drive or 28672 (112) for left drive.
- 5) Verify that first peak of burst occurs  $100 \pm 40$   $\mu$ sec after start of oscilloscope sweep. See Figure 13.

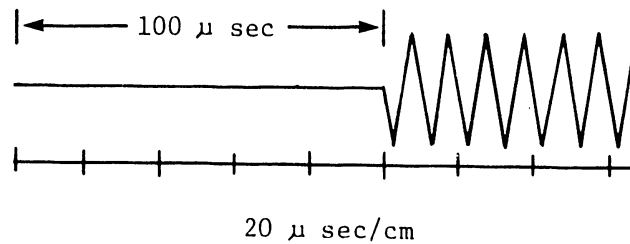

FIGURE 13

- 6) Access track 56 address 491520 (1049472) for the right drive address; 360448 (896) for the left drive.
- 7) Repeat step 5.
- 8) If tolerances specified in steps 5 and 7 are not met, perform index and sector timing alignment procedure (Section 5.3.3).
- 9) Disconnect and remove test equipment.

### 5.3.3 Index Alignment Procedure

- 1) Perform steps 2, 3, 4, 5, and 6 of Index Alignment Check if not already done.

- 2) Set time base to 10 ms/cm.
- 3) Insert screwdriver through baseplate top access hole (Figure 14) and rotate detector shaft as required to position burst within first 20 ms of oscilloscope sweep.
- 4) Expand oscilloscope time base to .1 msec/cm.
- 5) Rotate detector shaft to adjust burst so that first peak occurs 100  $\mu$ sec after start of sweep.
- 6) Expand oscilloscope time base to 20  $\mu$ sec/cm.
- 7) Repeat step 5.

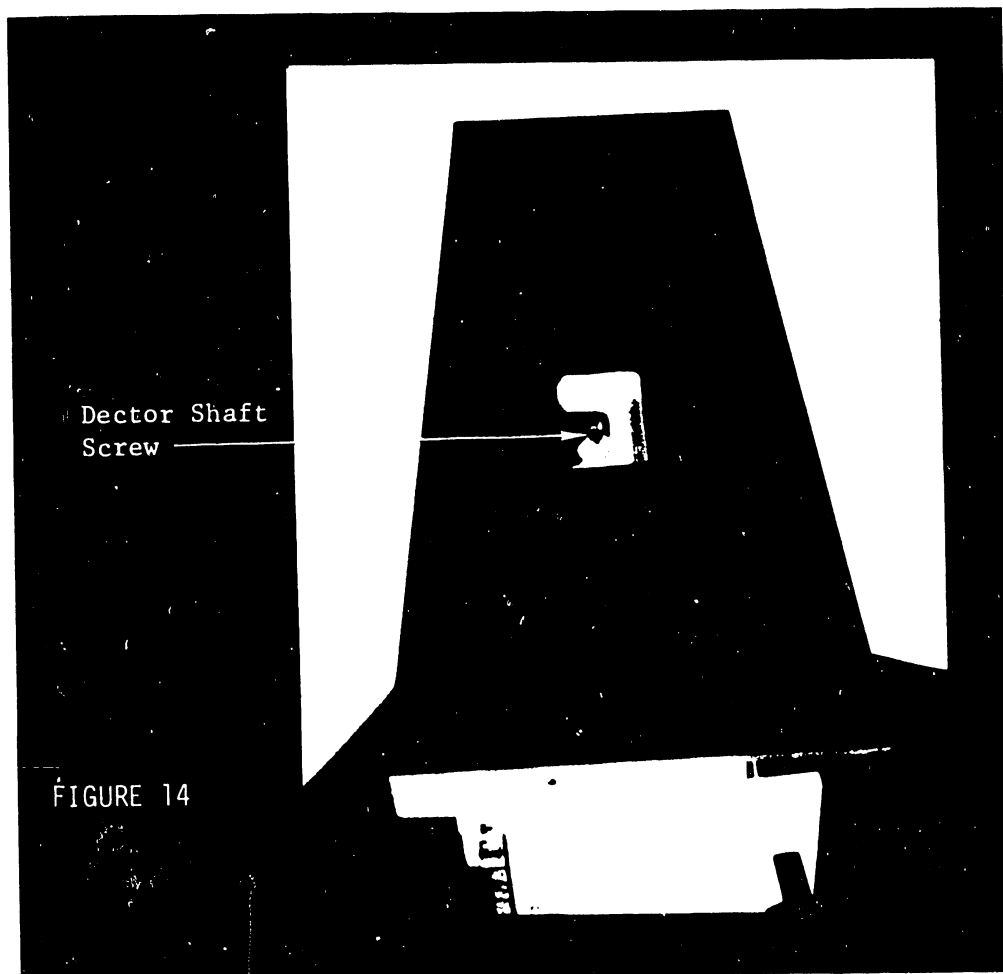

- 8) Access track 56 address 491520 (1049472) for right drive; address 360448 (896) for left drive). First peak of track 56 burst must occur  $100 \pm 40$   $\mu$ sec after start of sweep. If not, repeat step 5 and compensate this adjustment in the direction required to permit track 56 to be within tolerance. Do not exceed  $100 \pm 40$   $\mu$ sec setting at either track.
  
- 9) Access track 07 159744 (1048688) right, 28672 (112) left and repeat steps 5 through 8 until required tolerance is met on both tracks. Failure to meet tolerance specified may be caused by poor optical coupling between led and phototransistor, misaligned track position actuator, broken carriage, or damaged Field Service alignment disk.

#### 5.4 CARRIAGE STOP ADJUSTMENT PROCEDURE

- 1) Perform Head Radial Alignment Check.
  
- 2) Ground TP28, select unit, and access track 0.
  
- 3) Loosen rear carriage stop set screw (Figure 15).
  
- 4) Insert .007" (.018 cm) gauge (one data processing card) between rear carriage stop and carriage.
  
- 5) Press rear carriage stop firmly against gauge, tighten set screw and remove gauge.
  
- 6) Access track 63, address 524032 (1049584) for the right drive and 392960 (1008) for the left drive.
  
- 7) Repeat steps 3 through 5 for the front carriage stop.



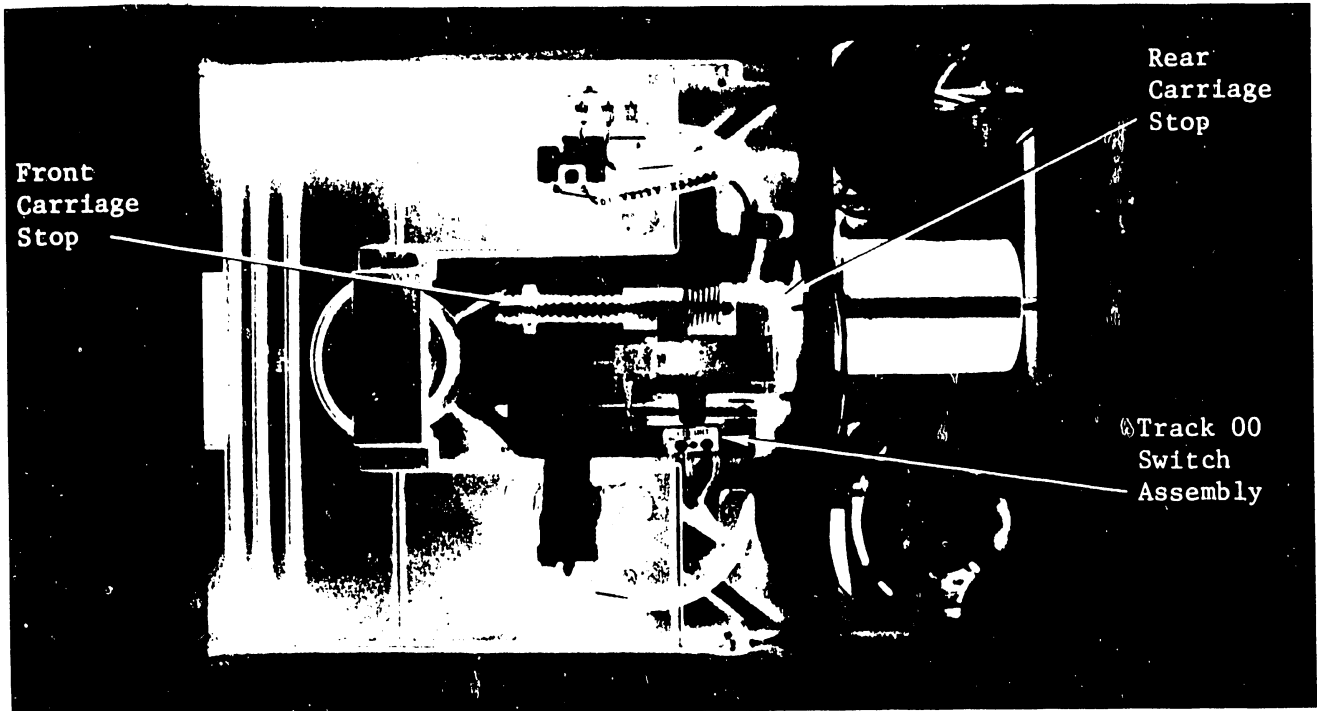

FIGURE 15

#### 5.5 TRACK 00 SWITCH ASSEMBLY (See Figure 15)

The Track 00 Switch is a two position actuator button switch that generates the track 00 head position status signal. The switch is actuated by a cam surface on the carriage assembly when the carriage is in the track 00 position. Following the head radial alignment, this switch must be positioned so that it is actuated when the head is positioned at track 01, and is deactivated when the head is stepped to track 02.

#### Track 00 Switch Assembly Adjustment Procedure

**NOTE:**

Carriage Stop Adjustment must be performed first.

- 1) Shut power off to unit (head must be at track 00).
- 2) Turn head screw to extend head so that the track 00 switch is disengaged.

- 3) Place a .028" (.071 cm) gauge between rear carriage stop and carriage.
- 4) Retract head by turning head screw.
- 5) With .028" (.071 cm) gauge between the rear carriage stop and the carriage the track 00 switch should be closed.
- 6) Turn head screw to extend head so that the track 00 switch is disengaged.
- 7) Place .049" (.124 cm) gauge between rear carriage stop and carriage.
- 8) Retract head by turning head screw.
- 9) With .049" (.124 cm) gauge between the rear carriage stop and the carriage the track 00 switch should not be closed.
- 10) To adjust track 00 switch assembly, loosen the two screws mounting the assembly to the chassis and adjust as necessary to achieve the conditions set in steps 5 and 9 (Figure 13).

## APPENDIX A

## 640 BEGINNING AND ENDING TRACK ADDRESSES

TRACK #	LEFT DISK ADDRESSES	RIGHT DISK ADDRESSES
0	0-15	1048576-1048591
1	16-31	1048592-1048607
2	32-47	1048608-1048623
3	48-63	1048624-1048639
4	64-79	1048640-1048655
5	80-95	1048656-1048671
6	96-111	1048672-1048687
7	112-127	1048688-1048703
8	128-143	1048704-1048719
9	144-159	1048720-1048735
10	160-175	1048736-1048751
11	176-191	1048752-1048767
12	192-207	1048768-1048783
13	208-223	1048784-1048799
14	224-239	1048800-1048815
15	240-255	1048816-1048831
16	256-271	1048832-1048847
17	272-287	1048848-1048863
18	288-303	1048864-1048879
19	304-319	1048880-1048895
20	320-335	1048896-1048911
21	336-351	1048912-1048927
22	352-367	1048928-1048943
23	368-383	1048944-1048959
24	384-399	1048960-1048975
25	400-415	1048976-1048991
26	416-431	1048992-1049007
27	432-447	1049008-1049023
28	448-463	1049024-1049039
29	464-479	1049040-1049055
30	480-495	1049056-1049071

## 640 ADDRESSES, CONTINUED

TRACK #	LEFT DISK ADDRESSES	RIGHT DISK ADDRESSES
31	496-511	1049072-1049087
32	512-527	1049088-1049103
33	528-543	1049104-1049119
34	544-559	1049120-1049135
35	560-575	1049136-1049151
36	576-591	1049152-1049167
37	592-607	1049168-1049183
38	608-623	1049184-1049199
39	624-639	1049200-1049215
40	640-655	1049216-1049231
41	656-671	1049232-1049247
42	672-687	1049248-1049263
43	688-703	1049264-1049279
44	704-719	1049280-1049295
45	720-735	1049296-1049311
46	736-751	1049312-1049327
47	752-767	1049328-1049343
48	768-783	1049344-1049359
49	784-799	1049360-1049375
50	800-815	1049376-1049391
51	816-831	1049392-1049407
52	832-847	1049408-1049423
53	848-863	1049424-1049439
54	864-879	1049440-1049455
55	880-895	1049456-1049471
56	896-911	1049472-1049487
57	912-927	1049488-1049503
58	928-943	1049504-1049519
59	944-959	1049520-1049535
60	960-975	1049536-1049551
61	976-991	1049552-1049567
62	992-1007	1049568-1049583
63	1008-1023	1049584-1049599

## APPENDIX B

## 740 BEGINNING AND ENDING TRACK ADDRESSES

TRACK #	LEFT DISK ADDRESSES	RIGHT DISK ADDRESSES
0	0-4095	131072-135167
1	4096-8191	135168-139263
2	8192-12287	139264-143359
3	12288-16383	143360-147455
4	16384-20479	147456-151551
5	20480-24575	151552-155647
6	24576-28671	155648-159743
7	28672-32767	159744-163839
8	32768-36863	163840-167935
9	36864-40959	167936-172031
10	40960-45055	172032-176127
11	45056-49151	176128-180223
12	49152-53247	180224-184319
13	53248-57343	184320-188415
14	57344-61439	188416-192511
15	61440-65535	192512-196607
16	65536-69631	196608-200703
17	69632-73727	200704-204799
18	73728-77823	204800-208895
19	77824-81919	208896-212991
20	81920-86015	212992-217087
21	86016-90111	217088-221183
22	90112-94207	221184-225279
23	94208-98303	225280-229375
24	98304-102399	229376-233471
25	102400-106495	233472-237567
26	106496-110591	237568-241663
27	110592-114687	241664-245759
28	114688-118783	245760-249855
29	118784-122879	249856-253951
30	122880-126975	253952-258047

## 740 ADDRESSES, CONTINUED

TRACK #	LEFT DISK ADDRESSES	RIGHT DISK ADDRESSES
31	126976-131071	258048-262143
32	262144-266239	393216-397311
33	266240-270335	397312-401407
34	270336-274431	401408-405503
35	274432-278527	405504-409599
36	278528-282623	409600-413695
37	282624-286719	413696-417791
38	286720-290815	417792-421887
39	290816-294911	421888-425983
40	294912-299007	425984-430079
41	299008-303103	430080-434175
42	303104-307199	434176-438271
43	307200-311295	438272-442367
44	311296-315391	442368-446463
45	315392-319487	446464-450559
46	319488-323583	450560-454655
47	323584-327679	454656-458751
48	327680-331775	458752-462847
49	331776-335871	462848-466943
50	335872-339967	466944-471039
51	339968-344063	471040-475135
52	344064-348159	475136-479231
53	348160-352255	479232-483327
54	352256-356351	483328-487423
55	356352-360447	487424-491519
56	360448-364543	491520-495615
57	364544-368639	495616-499711
58	368640-372735	499712-503807
59	372736-376831	503808-507903
60	376832-380927	507904-511999
61	380928-385023	512000-516095
62	385024-389119	516096-520191
63	389120-393215	520192-524287

APPENDIX C

2240 BEGINNING AND ENDING TRACK ADDRESSES

TRACK #	LEFT AND RIGHT DISK ADDRESSES
0	0-15
1	16-31
2	32-47
3	48-63
4	64-79
5	80-95
6	96-111
7	112-127
8	128-143
9	144-159
10	160-175
11	176-191
12	192-207
13	208-223
14	224-239
15	240-255
16	256-271
17	272-287
18	288-303
19	304-319
20	320-335
21	336-351
22	352-367
23	368-383
24	384-399
25	400-415
26	416-431
27	432-447
28	448-463
29	464-479
30	480-495

## 2240 ADDRESSES, CONTINUED

TRACK #	LEFT AND RIGHT DISK ADDRESSES
31	496-511
32	512-527
33	528-543
34	544-559
35	560-575
36	576-591
37	592-607
38	608-623
39	624-639
40	640-655
41	656-671
42	672-687
43	688-703
44	704-719
45	720-735
46	736-751
47	752-767
48	768-783
49	784-799
50	800-815
51	816-831
52	832-847
53	848-863
54	864-879
55	880-895
56	896-911
57	912-927
58	928-943
59	944-959
60	960-975
61	976-991
62	992-1007
63	1008-1023



APPENDIX D

Conversion from 640/740 to 2240

1. Change PROMs on 6298 board.
2. Change jumper on 6395 from 5MHz to 10MHz, and turn all switches ON.
3. Change the I/O cable:

END	WIRE FROM	WIRE TO
Amphenol	Pin 33	Pin 11
Fingerboard	Pin 13	Pin 10

**SERVICE  
BULLETIN  
NO. 46.1**

# SERVICE BULLETIN

# NO. 46.1

EDITED BY CUSTOMER ENGINEERING DIVISION

MODEL 2242 SINGLE REMOVABLE DISK DRIVE

MODEL 2243 TRIPLE REMOVABLE DISK DRIVE

This Bulletin is a supplement to *Service Bulletin 46*; it is written with the assumption that *S.B. #46* has been read. The Model 2240, 2242, and 2243 are all similar in installation, operation, and maintenance. Only unit differences are explained in this Bulletin.

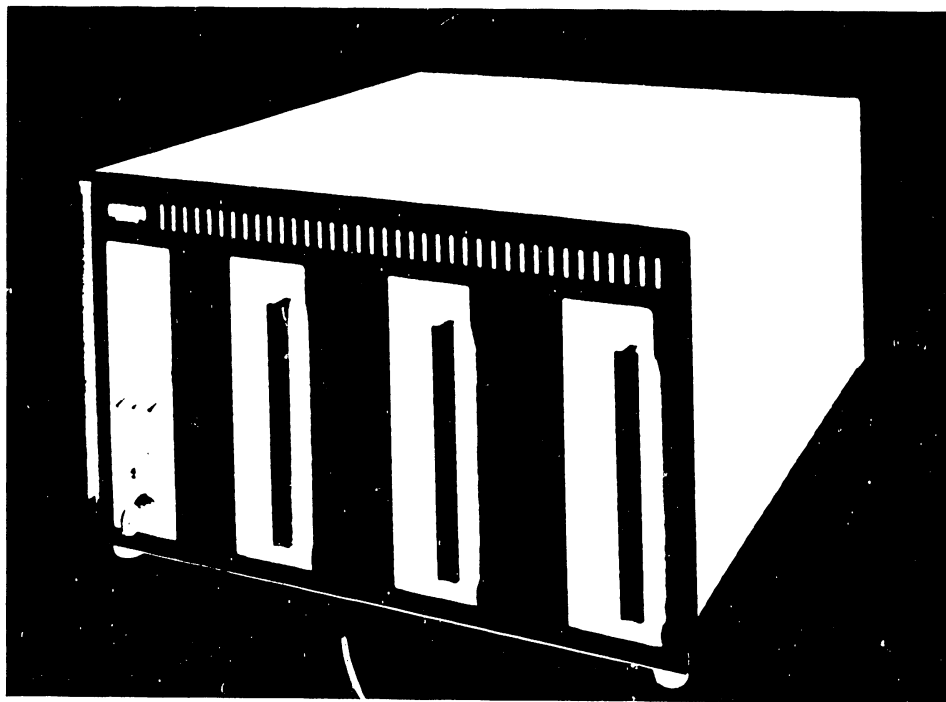

**NOTICE:**

This document is the property of Wang Laboratories, Inc. Information contained herein is considered company proprietary information and its use is restricted solely to the purpose of assisting you in servicing Wang products. Reproduction of all or any part of this document is prohibited without the consent of Wang Laboratories.

**WANG**

LABORATORIES, INC.

836 NORTH STREET, TEWKSBURY, MASSACHUSETTS 01876, TEL. (617) 851-4111, TWX 710 343-6769, TELEX 94-7421

Printed in U.S.A.  
13-210

# MODELS 2242 AND 2243

## TABLE OF CONTENTS

1.	DESCRIPTION . . . . .	3
1.1	General . . . . .	3
1.2	Model 2242 . . . . .	3
1.3	Model 2243 . . . . .	4
2.	MODEL 2242 AND 2243 INSTALLATION . . . . .	4
2.1	2242 . . . . .	4
2.2	2243 . . . . .	6
3.	OPERATION . . . . .	6
3.1	Indicator Lights and Switches for 2242 and 2243 . . . . .	6
3.2	Loading and Handling of Disk Cartridges . . . . .	7
3.3	Disk Formatting . . . . .	7
3.4	Addressing the Disk Cartridges in Each Model (2240, 2242, 2243) . . . . .	9
4.	DIAGNOSTICS . . . . .	11
4.1	2240/2242/2243 Microcode Diagnostic (Version 6/25/74) . . . . .	11
4.2	2240/2242/2243 Hardware Diagnostic . . . . .	12
5.	MAINTENANCE . . . . .	13
	APPENDIX A - 2242 to 2240 Conversion Procedure . . . . .	14
	APPENDIX B - 640/740/2240 Assembly Drawings . . . . .	14

# 1. DESCRIPTION

## 1.1 GENERAL

The 2242 and 2243 disk units utilize the same Memorex 651 Disk Drives and FD/IV Flexible Disk Cartridges as the 2240. The 2242 utilizes the same basic chassis as the 2240 whereas the 2243 chassis is altered to allow room for three disk drives.

## 1.2 MODEL 2242

The 2242 contains one disk drive and is equivalent to a 2240-1 in capacity; it contains 262,144 bytes of memory. The disk cartridge contains 64 tracks with 16 sectors per track. The sectors are numbered sequentially from 0-1023. The 2242 is identical to the 2240 except for the following:

- (a) Only one disk drive is used; it is located on the left of the unit.
- (b) The door on the right is secured by bolts to help prevent dust from entering the unit.
- (c) The 6395 board has one minor change. The etch going to pin 11<sub>3</sub> is cut and tied to ground.
- (d) The front panel is changed. There are no select lights for left and right disk select; the select switch is absent.
- (e) The 6392 front panel board has a jumper wire from the center of the switch mounting hole to the left disk select line.
- (f) The microprogram is different requiring new PROMs on the 6298 board:

L3	L4	L7	L8
378-0279	378-0281	378-0280	378-0282

### 1.3 MODEL 2243 - See Figure 1

The 2243 has three disk drives; it contains 786,432 bytes of memory. The drives are referred to as disk drives #1, #2, and #3. The drives are arranged in sequence to the right of the control panel.

The 2243 differs from the 2240 in the following ways:

- (a) The 6395 board is replaced by the 6537.
- (b) The microprogram is different requiring new PROMs on the 6298 board:

L3	L4	L7	L8
378-0283R1	378-0285R1	378-0284R1	378-0286R1

- (c) The motherboard is changed from a 6390 to a 6538.
- (d) The power supply motherboard is changed from a 6391 to a 6539.
- (e) The front panel is changed to provide three disk select lights and three format control switches.
- (f) The front panel board is changed from a 6392 to a 6540.
- (g) On the 2200 CPU, the 6375 I/O disk controller board is replaced by the 6541. (This board allows the third disk drive to be accessed.)

## 2. MODEL 2242 AND 2243 INSTALLATION

### 2.1 2242

The 2242 installation procedure is identical to that for the 2240 in *S.B. #46* pages 16-19.

REAR

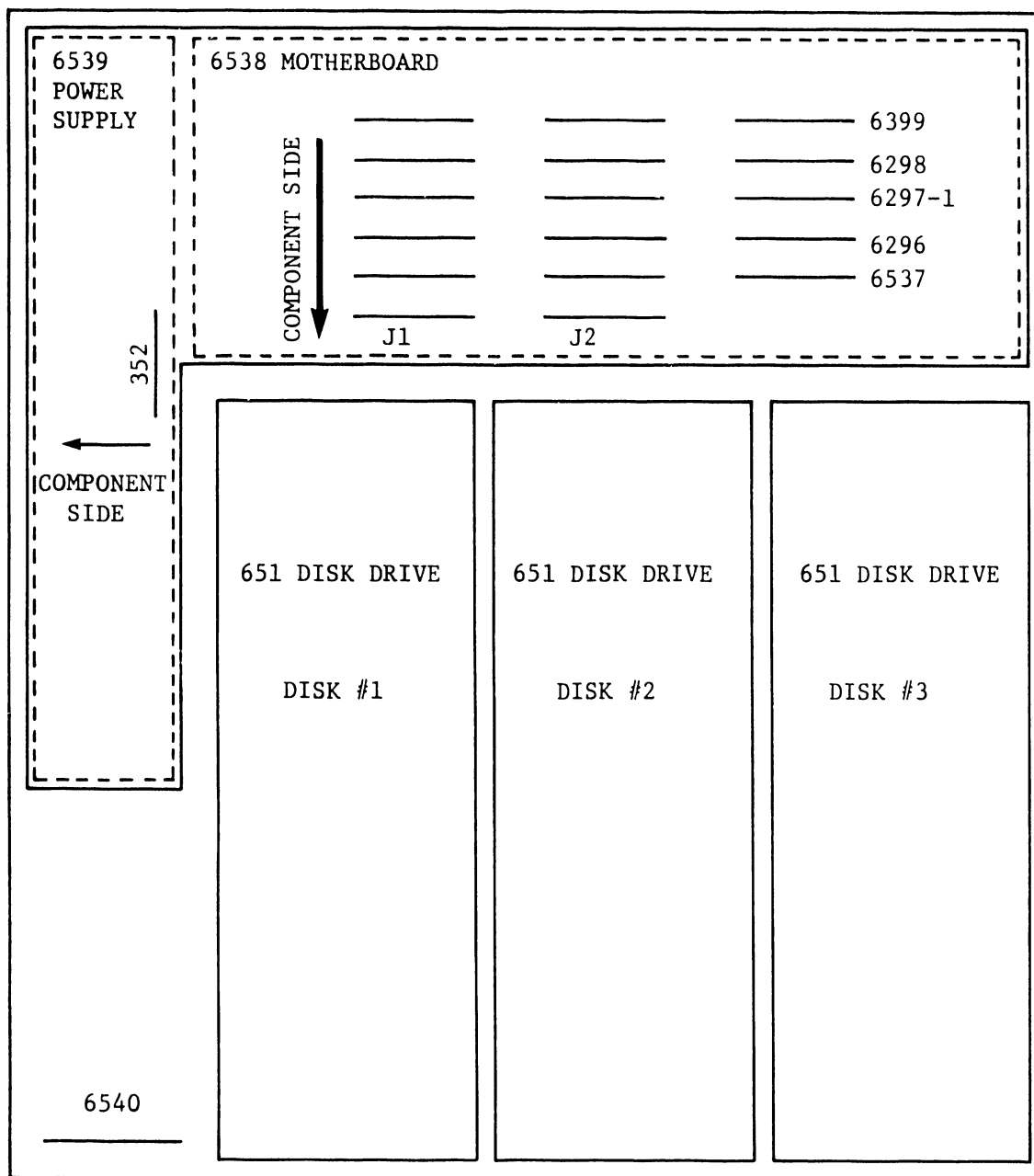

FRONT

FIGURE 1

NOTE:

The caution on page 16 of *S.B. #46* no longer applies because of the new arrangement of the shipping tape.

2.2 2243

After removing the cover and front panel, remove the center disk drive from the unit by tilting the unit so that it is resting on its rear feet.

CAUTION:

Do not tilt the unit more than 30° or fuseholder damage may occur.

Remove the two rear mounting bolts. Ease the unit down and slide the unit forward so that it is overhanging on its resting surface. Remove the two front mounting bolts. With the center disk removed, all the adjustments outlined in *S.B. #46* should be performed.

CAUTION:

Upon assembly of the front panel, insure that the disk drives are perpendicular to the front panel to allow the drive door to close completely. Failure to do so may cause damage to the flexible disk cartridge.

Install the 6541 I/O controller board in the 2200 CPU insuring that the address switches are set to  $10_{16}$ .

3. OPERATION

3.1 INDICATOR LIGHTS AND SWITCHES FOR 2242 AND 2243

1) POWER.

A lamp that illuminates when the power switch on the rear of the unit is turned on.



2) ERROR.

Informs the operator of several types of errors:

- (a) *Flashing* - Indicates an illegal address given to the disk unit.
- (b) *On* - Indicates either an incorrect read, legal address requested cannot be located, or unit unable to format a cartridge properly.

3) LOCK/ON.

When in the LOCK position, no formatting is possible; ON allows formatting but no information transfer.

4) FORMAT SWITCH.

When depressed, with the key in the ON position, initiates formatting of a disk.

5) FORMAT INDICATOR.

Illuminates when any disk is being formatted. Flashes when data transfer is attempted while the format key is ON.

6) DISK SELECT LIGHTS 1, 2, and 3 (2243 ONLY).

Indicates which disk is being formatted or accessed.

### 3.2 LOADING AND HANDLING OF DISK CARTRIDGES

See S.B. #46 pages 20-22.

### 3.3 DISK FORMATTING

Whenever a new disk cartridge is loaded into a disk drive, the new cartridge must be formatted. Also, if an old disk is causing read/write errors, reformatting may correct the problem. Every disk must be formatted at least once. The formatting procedure results in the automatic recording of addresses on the disk which enables the disk controller to locate addresses on the disk for reading and writing purposes.

FORMATTING PROCEDURE FOR 2242 AND 2243

- 1) Turn the format key on the front panel of the disk unit to the ON position.
- 2) 2243 Only - Turn on (up position) one of the format control switches labeled 1,2,3. The light above the appropriate switch illuminates.
- 3) On the 2200 keyboard, key RESET.
- 4) Press the FORMAT SWITCH. Formatting begins immediately, signaled by the format indicator light illuminating. The format light goes off when formatting is complete.

NOTE:

It takes approximately 40 seconds to format a disk if the first attempt is successful. The 2242 and 2243 automatically try to format a disk four times. Should the format light remain on for more than 3 minutes, the system has been unsuccessful in formatting a disk. The error light also illuminates. Repeat the procedure from step 1 after checking that the disk drive door is properly closed and/or trying another disk cartridge.

- 5) When the format indicator light goes off, the disk cartridge has been formatted.
- 6) Turn the format key off. The unit cannot be accessed while the format key is on.
- 7) 2243 Only - Repeat steps 1-6 for any additional disk cartridges that need to be formatted.

### 3.4 ADDRESSING THE DISK CARTRIDGES IN EACH MODEL (2240, 2242, 2243)

#### (a) "F" AND "R" PARAMETERS.

The 2200 CPU regards a disk unit as a discrete peripheral device that contains two disk drives. Two parameters, "F" and "R", are used to identify the disk drives. In the 2242, only the "F" parameter is applicable. The 2243, which contains three disk drives, requires a special procedure for accessing the third drive.

The table below illustrates the relationship between the "F" and "R" parameters and the disks:

PARAMETER	MODEL 2240	MODEL 2242	MODEL 2243*
F	LEFT DISK	LEFT DISK	DISK #1
R	RIGHT DISK	NOT LEGAL	DISK #2

\*A special procedure is required to address the third disk.

The "F" or "R" parameter must be included in a disk statement to access a particular disk cartridge. For example, the statement

```
10 LOAD DC F "PROG 1"
```

accesses the left disk cartridge in the 2240 and 2242, and disk cartridge #1 in the 2243. The statement

```
20 LOAD DC R "PROG 2"
```

accesses the right disk cartridge in the 2240 and disk cartridge #2 in the 2243. The statement above is illegal for the 2242 which does not have a right disk.

#### (b) DISK DEVICE ADDRESSES.

In addition to the "F" and "R" parameters that identify the disk cartridges, the disk unit must be addressed. Device address  $310_{16}$  is assigned to the first disk unit with  $320_{16}$  to the second and  $330_{16}$  to the third.

The disk device address can be included in a disk statement:

```
10 LOAD DC F /310, "PROG 3"
```

The address is preceded by a "/" when it specified in a disk statement.

It is unnecessary to address the first disk unit in a system because address 310 is a default address (when power is applied to the 2200 CPU it automatically selects address 310). A disk address must be included in a statement if more than one disk unit is connected to the system or if disk #3 is being addressed.

(c) 2243 DISK #3 ADDRESSING.

The 2200 only recognizes disks #1 and #2 with the "F" and "R" parameters respectively. Disk #3 is considered as being a separate unit and is accessed by the "F" or "R" parameter and address 350.

For example

```
10 LOAD DC F /350 "PROG 1"
```

accesses disk drive #3.

(d) LIMITATIONS AND FEATURES OF 2240, 2242, 2243

- 1) Model 2240 - All disk statements and commands can be used. The "F" parameter designates the left disk and the "R" parameter designates the right disk.
- 2) Model 2242 - All disk statements and commands can be used with the exception of disk to disk MOVE and COPY operations. The "R" parameter is illegal.
- 3) Model 2243 - Same as 2240. The MOVE and COPY operations cannot be used between disk #1 or #2 and #3 because the third disk is considered another unit.

#### 4. DIAGNOSTICS

Discard the present 2240 diagnostics (hardware and microcode) as they have several errors and will only check a 2240. The 2240/2242/2243 diagnostics (hardware and microcode) replace the 2240 only tests. Prior to running any disk diagnostic, insure that the switches on the 6375 or 6541 board are set to  $10_{16}$ .

##### 4.1 2240/2242/2243 MICROCODE DIAGNOSTIC (VERSION 6/25/74)

The 2240/2242/2243 Microcode Diagnostic checks the following instructions:

- (a) DALALOAD/DATASAVE DC OPEN
- (b) DATALOAD/DATASAVE DC
- (c) DATALOAD/DATASAVE DA
- (d) DATALOAD/DATASAVE BA
- (e) DSKIP, DBACKSPACE
- (f) VERIFY
- (g) LIMITS
- (h) MOVE END
- (i) CATALOGUE INDEX
- (j) SCRATCH DISK
- (k) COPY
- (l) MOVE
- (m) DATASAVE DC CLOSE
- (n) SCRATCH

An approximate time is displayed on the CRT for each test; this is the maximum time needed to check a 2243. The length of time decreases for the smaller capacity units. The test automatically rewinds the tape and repeats the diagnostic indefinitely if no error conditions exist.

1) Equipment Needed:

2200B1 (4K memory minimum)

2216/2217

2215 or 2222

2240, 2242, or 2243

2) Operating Instructions:

(a) Format all disks to be used if not already formatted.

(b) Insert tape into tape drive and rewind.

(c) Key: CLEAR EXECUTE

LOAD EXECUTE

RUN EXECUTE

(d) Key correct number, EXECUTE.

(e) To restart a test that terminated due to an error, key:

RESET RUN EXECUTE

4.2 2240/2242/2243 HARDWARE DIAGNOSTIC

The 2240/2242/2243 Hardware Diagnostic checks the following instructions:

- (a) TEST #1 - Writes at every sector address and reads the information to check for errors.
- (b) DATASAVE DA, DATALOAD DA from 1 to 10 variables.
- (c) ALPHANUMERIC VARIABLE
- (d) ALPHANUMERIC ARRAYS
- (e) DATASAVE BA, DATALOAD BA using numeric and alphanumeric sector addressing.
- (f) Read after write at 260 random locations.

Tests b, c, d, and e run five loops per disk drive. It is advisable to skip TEST #1 the first time because of the length of time required to complete TEST #1. After tests b, c, d, e, and f are completed, the program automatically rewinds the tape and runs TEST #1.

1) Equipment Needed:

2200B1 (4K memory minimum)

2216/2217

2215 or 2222

2240, 2242, or 2243

2) Operating Instructions:

(a) Format all disks to be used if not already formatted.

(b) Insert tape into tape drive and rewind.

(c) Key: CLEAR EXECUTE

LOAD EXECUTE

RUN EXECUTE

(d) Key correct number, EXECUTE.

(e) Key Y or N for TEST #1 (Y for TEST #1, N skip TEST #1).

5. MAINTENANCE

See S.B. #46 pages 35-47.

APPENDIX A

2242 TO 2240 CONVERSION PROCEDURE

- 1) Replace PROMs on 6298 board with those listed on page 9 of S.B. #46.
- 2) Connect etch on pin 11<sub>3</sub> of 6395 board and remove the ground.
- 3) Remove the right door and hold bracket for the right disk.
- 4) Install right disk drive and interface cable.
- 5) Connect AC line to disk drive.
- 6) Replace front panel.

APPENDIX B

640/740/2240 ASSEMBLY DRAWINGS

D6499-32	Control Panel Assembly
E6499-33	Chassis Sub Assembly
E6499-34	Main Assembly



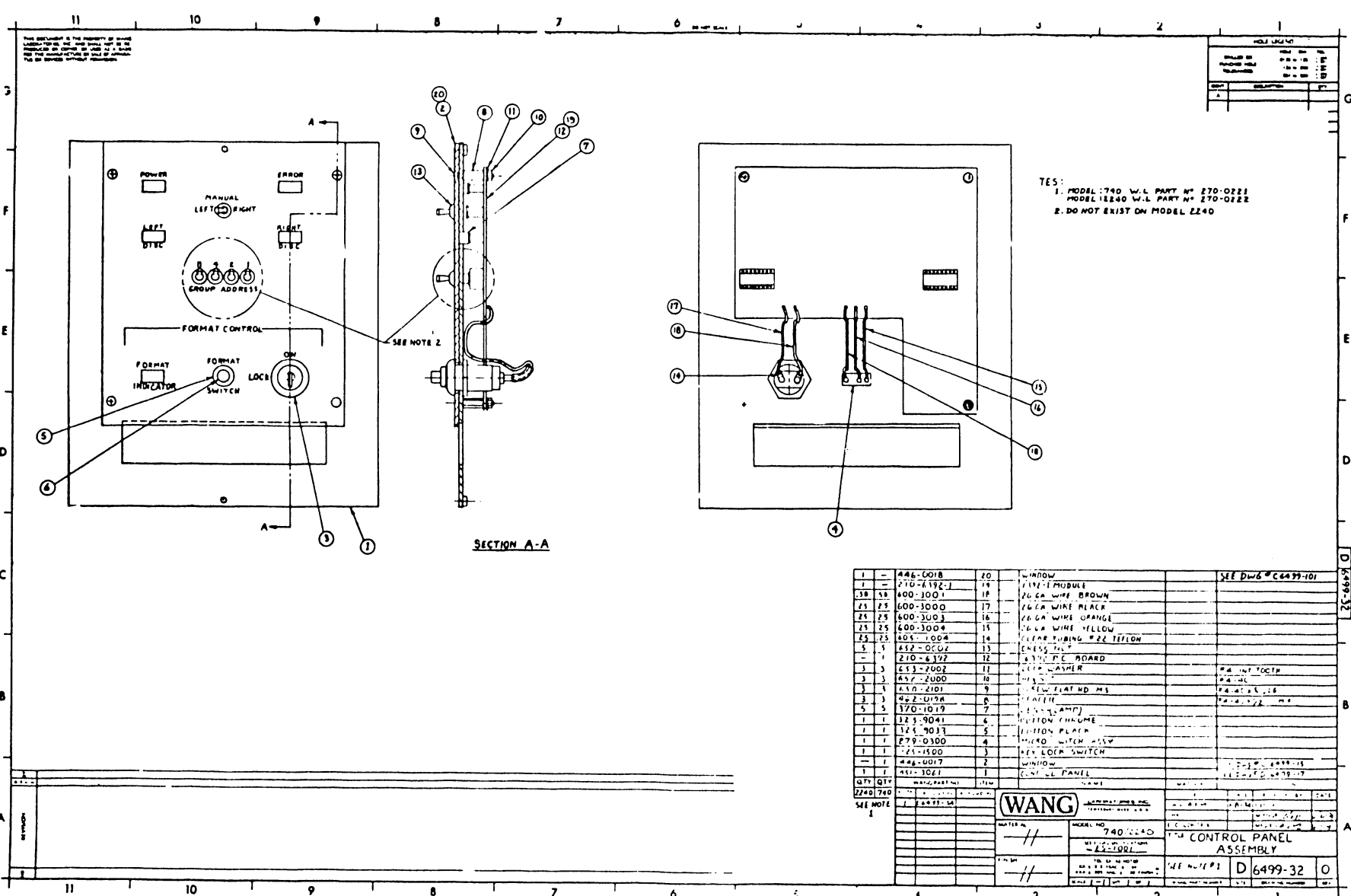

This document is the property of Wang Laboratories, Inc. and shall not be reproduced or copied in whole or in part without the written consent of Wang Laboratories, Inc.

WANG LOG NO.			
DATE	BY	NO.	REV.

TES:  
 1. MODEL 740 W.L. PART # 270-0221  
 MODEL 1240 W.L. PART # 270-0222  
 2. DO NOT EXIST ON MODEL 2240

15

SECTION A-A

QTY	QTY	WANG PART NO.	ITEM	WANG PART NO.	ITEM
1	1	446-0018	WINDOW	20	WINDOW
1	1	270-6392-1	270-6392-1 MODULE	19	270-6392-1 MODULE
18	18	400-3001	26 GA WIRE BROWN	18	26 GA WIRE BROWN
25	25	400-3002	26 GA WIRE BLACK	17	26 GA WIRE BLACK
25	25	400-3003	26 GA WIRE ORANGE	16	26 GA WIRE ORANGE
25	25	400-3004	26 GA WIRE YELLOW	15	26 GA WIRE YELLOW
25	25	404-1004	CLEAR TUBING #22 TITAN	14	CLEAR TUBING #22 TITAN
5	5	452-0002	WESS TUB	13	WESS TUB
1	1	210-6392	270-6392 BOARD	12	270-6392 BOARD
3	3	453-2002	WATER WASHER	11	WATER WASHER
3	3	457-2000	WATER	10	WATER
3	3	450-2101	WATER FLAT HD MS	9	WATER FLAT HD MS
3	3	442-0198	WATER	8	WATER
5	5	170-1019	WESS TAMP	7	WESS TAMP
1	1	125-9041	WATER CRADLE	6	WATER CRADLE
1	1	125-9037	WATER PLATE	5	WATER PLATE
1	1	279-0300	WATER SWITCH ASSY	4	WATER SWITCH ASSY
1	1	22-1500	WATER LOCK SWITCH	3	WATER LOCK SWITCH
1	1	446-0017	WINDOW	2	WINDOW
1	1	451-3021	CONTROL PANEL	1	CONTROL PANEL

SEE NOTE 1  
 2240 740  
 SEE NOTE 1

WANG	MODEL NO. 740-0240	CONTROL PANEL ASSEMBLY
DATE	1968-11-15	REV. 1
BY		
CHECKED		
APPROVED		

SEE NOTE 1  
 D 6499-32 0



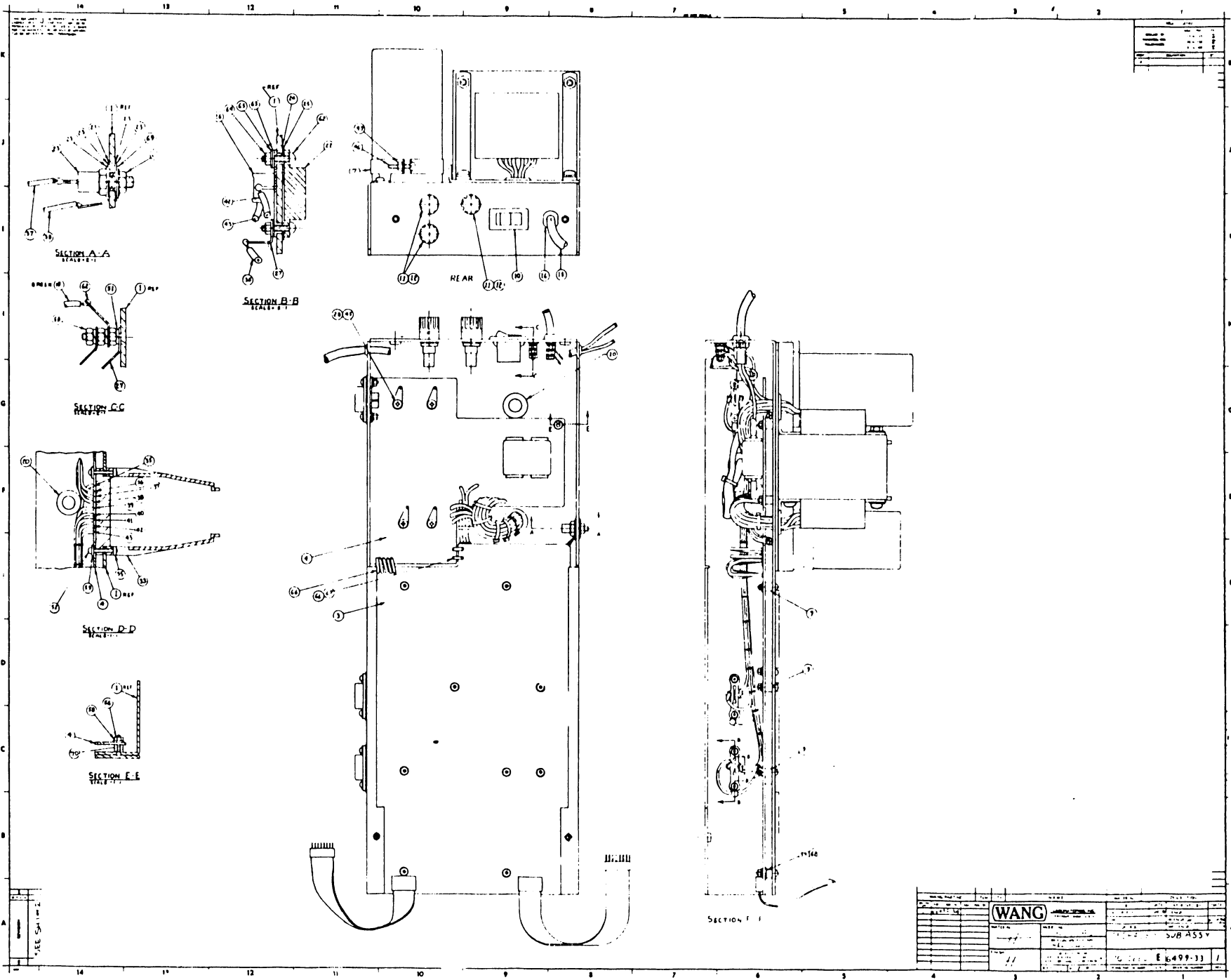

DATE	BY	CHKD	APP'D

WANG		NO. 499-33
DATE	BY	CHKD
SUB ASSY		
E 499-33		

17

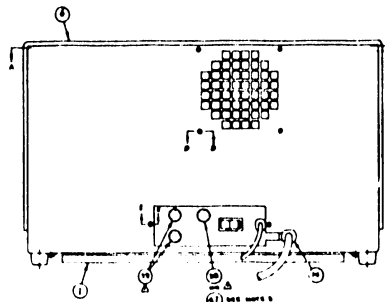
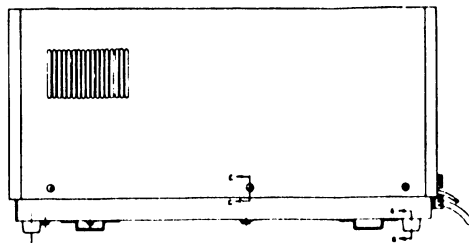
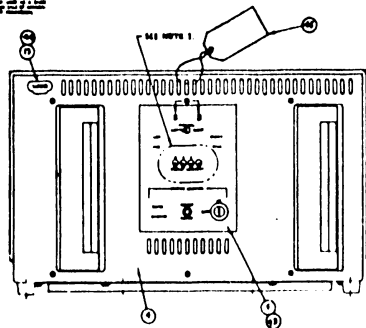

NOTE:  
 1 SWITCHES DO NOT EXIST ON 1200 FRONT PANEL ASSEMBLY  
 2 MODEL 740 W/L # 117 0001  
 3 MODEL 740 W/L # 117 1240  
 4 AS SHOWN ON DRAWING FROM 1200 VIEW OF DEPENDS ON CONTRACTOR'S BEST TO ORIGINAL MANUFACTURE

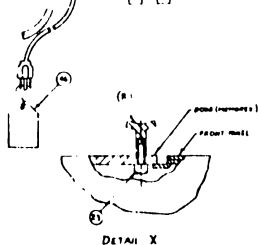
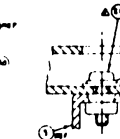
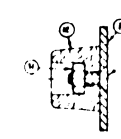
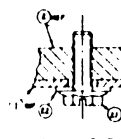
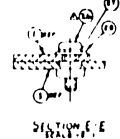
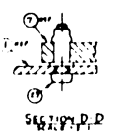
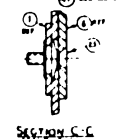
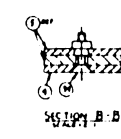
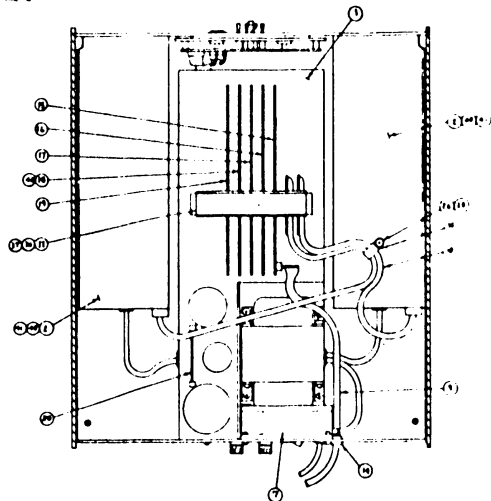
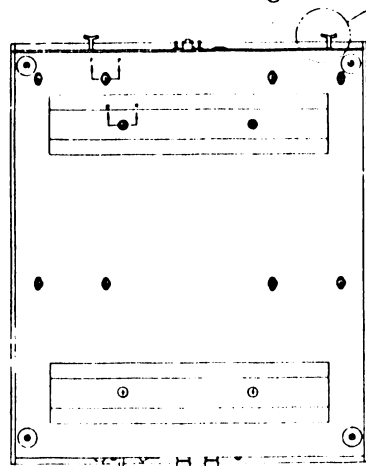

SECTION A-A

LINE NO.	DESCRIPTION	QTY	UNIT	REMARKS
1	...	...	...	...
2	...	...	...	...
3	...	...	...	...
4	...	...	...	...
5	...	...	...	...
6	...	...	...	...
7	...	...	...	...
8	...	...	...	...
9	...	...	...	...
10	...	...	...	...
11	...	...	...	...
12	...	...	...	...
13	...	...	...	...
14	...	...	...	...
15	...	...	...	...
16	...	...	...	...
17	...	...	...	...
18	...	...	...	...
19	...	...	...	...
20	...	...	...	...
21	...	...	...	...
22	...	...	...	...
23	...	...	...	...
24	...	...	...	...
25	...	...	...	...
26	...	...	...	...
27	...	...	...	...
28	...	...	...	...
29	...	...	...	...
30	...	...	...	...
31	...	...	...	...
32	...	...	...	...
33	...	...	...	...
34	...	...	...	...
35	...	...	...	...
36	...	...	...	...
37	...	...	...	...
38	...	...	...	...
39	...	...	...	...
40	...	...	...	...
41	...	...	...	...
42	...	...	...	...
43	...	...	...	...
44	...	...	...	...
45	...	...	...	...
46	...	...	...	...
47	...	...	...	...
48	...	...	...	...
49	...	...	...	...
50	...	...	...	...
51	...	...	...	...
52	...	...	...	...
53	...	...	...	...
54	...	...	...	...
55	...	...	...	...
56	...	...	...	...
57	...	...	...	...
58	...	...	...	...
59	...	...	...	...
60	...	...	...	...
61	...	...	...	...
62	...	...	...	...
63	...	...	...	...
64	...	...	...	...
65	...	...	...	...
66	...	...	...	...
67	...	...	...	...
68	...	...	...	...
69	...	...	...	...
70	...	...	...	...
71	...	...	...	...
72	...	...	...	...
73	...	...	...	...
74	...	...	...	...
75	...	...	...	...
76	...	...	...	...
77	...	...	...	...
78	...	...	...	...
79	...	...	...	...
80	...	...	...	...
81	...	...	...	...
82	...	...	...	...
83	...	...	...	...
84	...	...	...	...
85	...	...	...	...
86	...	...	...	...
87	...	...	...	...
88	...	...	...	...
89	...	...	...	...
90	...	...	...	...
91	...	...	...	...
92	...	...	...	...
93	...	...	...	...
94	...	...	...	...
95	...	...	...	...
96	...	...	...	...
97	...	...	...	...
98	...	...	...	...
99	...	...	...	...
100	...	...	...	...

(WANG)

**END**