

PRODUCT SERVICE NOTICE

DATE : 12/15/82

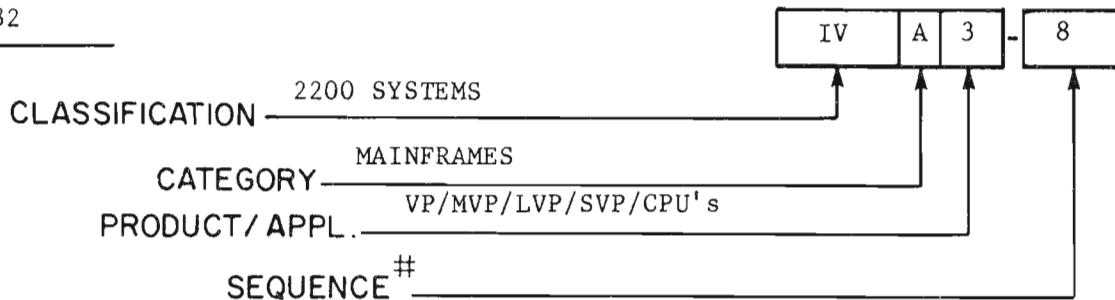

TITLE:

2200 SVP OPTION W BOARD INSTALLATION

This PSN provides installation, checkout, and operating instructions for the optional 210-7486 Multi-Terminal SVP Board (Option W) used to replace the original 2200 SVP Board (P/N 210-7789). The Multi-Terminal SVP Board supports one, two, or three workstations and a printer. The original 7789 board supports only one workstation and a printer.

The information in this PSN is presented under the following headings:

- 1.0 RELATED DOCUMENTATION
- 2.0 EQUIPMENT REQUIRED
- 3.0 INSTALLATION PROCEDURE
- 4.0 OPERATION.



IV.A.3

1.0 RELATED DOCUMENTATION

Refer to the following publications for further information concerning the equipment described in this PSN:

2236 MXE TERMINAL CONTROLLER: reorder number 729-1127

2200 SVP MANUAL: reorder number 729-0935

2.0 EQUIPMENT REQUIRED

A standard loopback connector (P/N 210-1040) is the only special item required. This connector is used during the testing of the 7846 board in the system.

NOTE

If the 2200 SVP system's rear panel does not contain a mounting plate hole (See Figure 1), a replacement rear plate (P/N 270-0683) must be ordered. Equally important, the 7846 option W requires that the system contains a 210-7588-1 (32K control memory) board (See Figure 1). Check to ensure this board is included before running the 2.4 MVP system software.

3.0 INSTALLATION PROCEDURE

1. Turn system power OFF.
2. Using a Phillips screwdriver, remove the six screws, three on each side of the unit, that secure the sides of the cover. Next, remove the two screws that secure the cover to the rear of the chassis.
3. Slide the cover to the front of the unit, and then lift the cover off.
4. Remove the original 7789 board. See Figure 1.
5. As shown in Figure 2, set switches on the 7846 board as follows:

KEY:

0=OFF

1=ON

SW1 (Baud Rate)

SW2 (Baud Rate)

SW3 (Device Address)

SW1

SW2

SW3

1	ON	1	ON	1	OFF
2	OFF	2	OFF	2	OFF
3	ON	3	ON	3	OFF
4	ON	4	ON	4	OFF

REAR CONNECTOR PLATE MOUNTING HOLE 210-7588-1 PCB ORIGINAL 210-7789 PCB

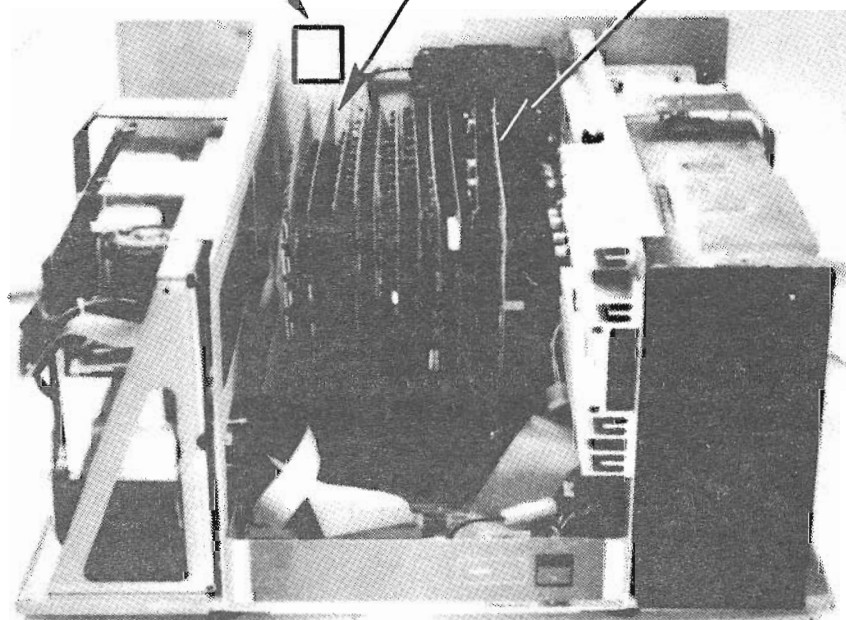

Figure 1. Component Locations

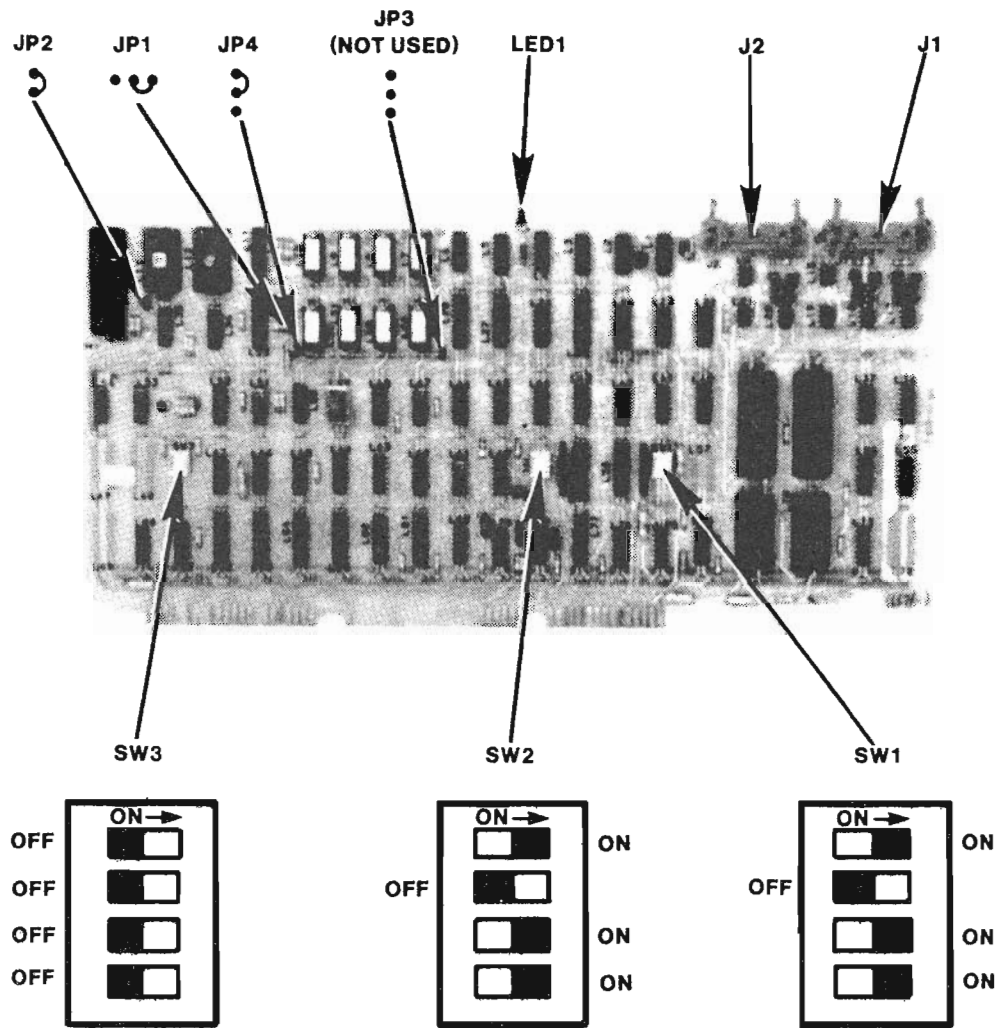

Figure 2. Option W Board Jumper and Switch Locations

NOTE: SW1 and SW2 settings, as specified in step 5, indicate the correct settings for 19.2 K baud rate. Refer to the table below for other correct settings:

SVP OPTION W HARDWARE SWITCH SETTINGS

<u>BAUD RATE</u>	<u>PORT 1 OR PORT 2</u>	<u>SW1 OR SW2</u>			
		<u>1</u>	<u>2</u>	<u>3</u>	<u>4</u>
9600		OFF	OFF	ON	ON
7600 (NOT USED)		ON	ON	OFF	ON
4800		OFF	ON	OFF	ON
3600 (NOT USED)		ON	OFF	OFF	ON
2400		OFF	OFF	OFF	ON
1800 (NOT USED)		ON	ON	ON	OFF
1200		OFF	ON	ON	OFF
600		ON	OFF	ON	OFF
300		OFF	OFF	ON	OFF
200		ON	ON	OFF	OFF
150		OFF	ON	OFF	OFF
134.5		ON	OFF	OFF	OFF
110		OFF	OFF	OFF	OFF

NOTE: Port 0 is automatically set for 19.2 K baud rate as its default setting.

IV.A.3

6. Check that the jumpers on the 7846 board are configured as shown in Figure 2.

NOTE JP3 is not used.

7. Insert the new 7846 board into the original 7789 board's slot. Check that the 7846 board is seated properly.
8. Remove the four screws securing the original rear connector cover plate from the cabinet.
9. Install ribbon cable assembly to top of option W board (J1) as illustrated in Figure 3. Run 7846 board's cable assembly to rear mounting hole.

CAUTION

Check to ensure that the cable assembly allows sufficient clearance from fan so as not to impede ventilation.

9. Connect the RS-232 cable connectors to their respective port locations.
10. Mount the new rear plate using the hardware supplied with the 7846 board. See Figure 4.
11. Power ON the system. The 7846 option W board is equipped with a power-up diagnostic. The power-up diagnostic run time is approximately six seconds. LED 1 at the top of the 7846 board (See Figure 2) indicates a GO or NO GO diagnostic condition as follows.
 - a. LED 1 will initially turn ON.
 - b. After approximately six seconds, LED 1 should turn OFF.
 - c. If it does turn OFF after this time elapses, the board has passed this hardware diagnostic.
 - d. If it does not turn OFF as described, a hardware problem with the 7846 board is indicated. At this time, remove the 7846 board and repeat the installation procedure using another 7846 option W board.
12. Install the cover and secure it with the eight previously removed screws.

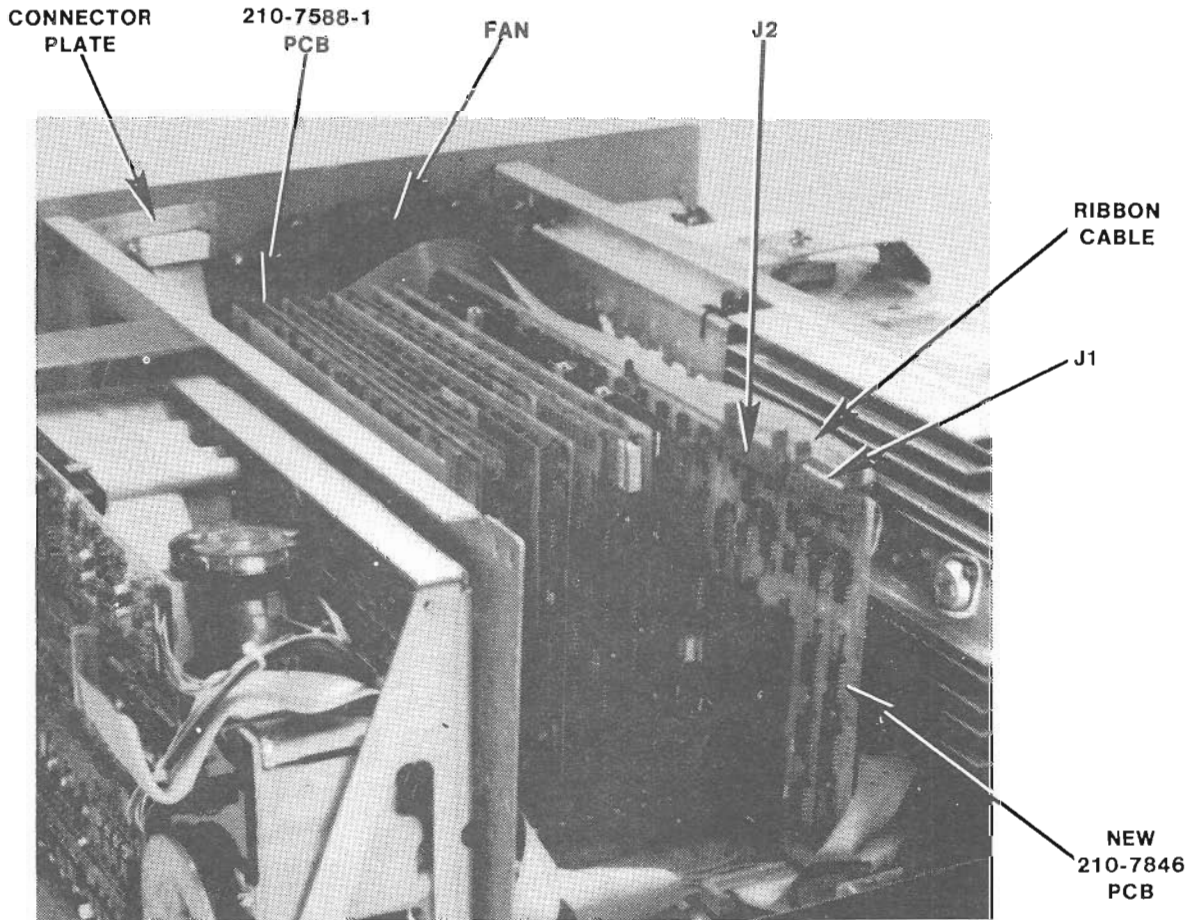
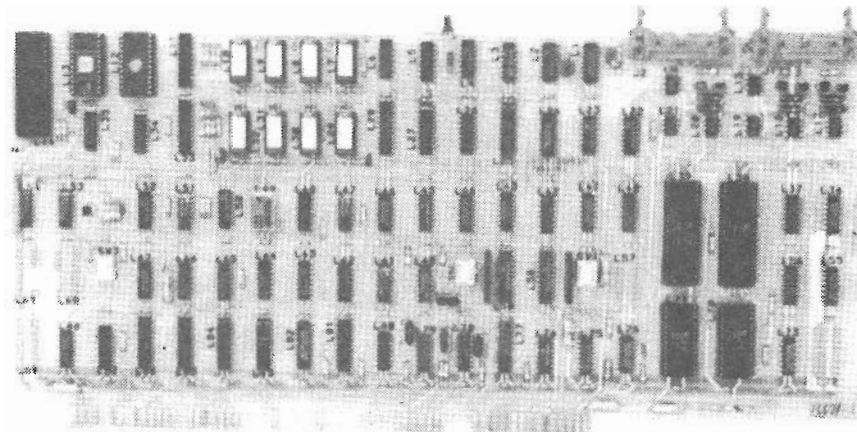
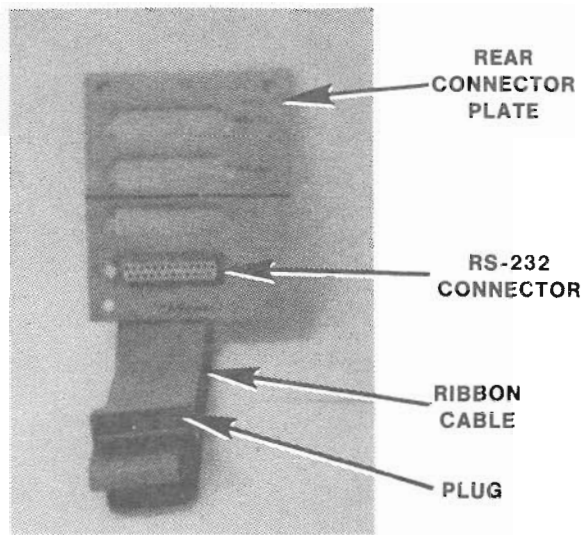

Figure 3. Ribbon Cable Routing

IV.A.3



210-7846 SVP BOARD

Figure 4. Option W Components Supplied

3.1 WANG TERMINAL TO OPTION W CONTROLLER INTERFACE

Each terminal can be attached locally to the SVP option W Terminal Controller at distances ranging up to 2,000 feet. Communication between the terminal and the SVP option W Terminal Processor is asynchronous and full-duplex, with selectable line speeds ranging from 50 through 19,200 bits per second (bps). The three ports, used in option W, are 25-pin and are RS 232-C compatible.

A local cable connection between the SVP option W and a terminal is less than 25 feet. For cable distances from 25 feet through 2,000 feet, optional direct connection cable is available. For cable distances beyond 2,000 feet, two asynchronous full-duplex, 11 bit, RS-232-C compatible modems per terminal must be used to provide the communication link over switched lines.

One modem is connected to a port on the terminal processor; the other is connected to a terminal. The WANG Model WA3451 Asynchronous/Synchronous Modem, which is compatible with 2200 SVP terminals, is the recommended modem for switched remote connection of these terminals to SVP systems.

Cable is optionally available for modem connections to WANG equipment in lengths of 12 feet, 25 feet, and 50 feet. Two lengths of modem cable for each terminal connection provide the required link between the terminal processor and its modem, and between the terminal and its modem.

3.2 PRINTERS/PLOTTERS TO OPTION W INTERFACE

A variety of printers, offering various speeds and print types, may be used with the 2200 SVP Option W. The printers supported range in speed from fifteen characters per second through 600 lines per minute, and these include matrix, chain, band, and daisy-wheel impact types. The option W also supports a selection of plotters that include drum, CRT, and daisy-wheel type. In addition, printer/plotter multiplexers are also available for use with the Option W. Refer to the appropriate sections in documentation category III.C for detailed information concerning these printers, plotters, and multiplexers.

NOTE: Due to the physical structure of the SVP Option W, only one printer or plotter is supported. If desired, an additional printer or plotter may be connected to the 2236DE Terminal.

3.3 INITIAL TURN-ON

After LED 1 turns OFF and, therefore, verifies that the hardware test is successfully completed, the terminals connected to ports 1, 2, and 3 should prompt similar to the following:

2236DE (or DW) R04 19200BPOS 8+0 (USA)

IV.A.3

This prompt is a self-identification message and consists of several fields separated by spaces. The following is a brief description of this message:

2236DE (DW)	the model number and is preceded by an asterisk.
R04	the revision number of the terminal firmware preceded by R.
19200BPS	the data rate followed by BPS.
8+0	the number of data bits (seven or eight). E is even parity; 0 is odd parity; N is no parity.
(USA)	the version of the keyboard and the CRT character set, enclosed in parenthesis.

Type "RESET" once. The following prompt should display:

'KEY SF'?

Load the 2.4 MVP software. The following diagnostic procedure is intended to test the 7846 board's performance in the system.

3.4 LOADING OPTION W (2.4) COMMAND CODE

The SVP option W responds to certain user commands by entering a "Command Mode". By using this feature, the user can set both the transmission rate and which port is to perform as Terminal 1 on the system. In addition, these can be set through the software alone, without manually resetting any switches. Command mode can be used: to set a system password, to test the RAM memory of the board, to lock the current transmission rate of the port issuing the command, and to list all commands. Since all command mode statements are password protected, only a privileged user has access to these commands.

To enter the option W command mode, press the "LOAD" key three times and observe the following screen prompt:

'ENTER COMMAND:' followed by a new line of '%'

The user should now enter the desired option W command, whose descriptions follow. The option W will process the command and will prompt for another command until the user enters a blank line. By entering a blank line, the user is returned to the previous mode. Note that the user should not key a command until an option W command mode prompt appears.

Any terminal may enter option W COMMAND MODE at ANY time. If the 2200 is displaying to the screen during command mode, the 2200 output will be temporarily suspended to prevent the two outputs from becoming intermixed.

3.5 COMMAND DEFINITIONS

For the command descriptions that follow, use these definitions:

The command "psw" is a six character password containing no blanks.

The command "port designator" is a one character designator. Note that 0 is equal to the port at which the command is being typed and, therefore, the user need not know which port he or she is connected to. Equally important, Port 4 is NOT used with option W. The C.E. can troubleshoot ports as follows:

Port 1	use standard SVP troubleshooting procedures
Port 2	use option W COMMAND MODE software diagnostic
Port 3	use option W COMMAND MODE software diagnostic
Port 4	not used

All commands possess a format depicted as follows. All begin with a ONE character command code. Most commands next have a six character password (which is the option W password) similar in use to the 2200 system password. These are followed by any necessary parameters in the order specified below. Note that the user can always type 'H' for 'HELP', while in the option W command mode, to obtain a list of command codes.

The command line is divided into three fields. The first field is a one character field. It identifies the program or the command to be run. The second field is a six character field. It contains the desired password for the option W command. Note that the password will NOT be printed on the screen. Instead, the option W will print the numbers, zero through 5, as the password characters are typed. As a result, the password is still protected for the user. The third field is used for setting the desired the command such as the "port designator", "baud rate", "new password", or some other option W command.

3.6 COMMANDS

This section includes command descriptions as well as the step by step procedure for entering the proper commands. While in command mode, there are two commands, Help and Status as described below, that are an important aid to the C.E..

IV.A.3

The first important command is 'H' (HELP). This command allows the user to see all the command code letters and definitions. To enter the 'H' (HELP) command code, procede as follows:

3.6.1 'H' (HELP) ALL COMMAND CODES

Steps:

1. Type 'H'
2. Return

Example: %H

```
CRT DISPLAY:  A Set VP user
               B Set Baud rate
               C Set psw
*            E Analog Loopback
*            F Digital Loopback
               H Help
               I RAM Test
               L Lock
               ? Status
```

* indicates the operator should use loopback connector, (P/N 210-1040), when running these tests.

The second important command is '?' (Status). Status ('?') shows the status of all ports on the SVP option W board. Specifically, it shows: 'ON' or 'OFF' line condition; 'Software Baud Rate' 'L' (Lock); '(Hardware Baud Rate)'. Procede as follows to enter the '?' (Status) command code.

3.6.2 '?' (Status)

Steps:

1. Type '?'
2. Return

Example: %?

```
CRT DISPLAY:  Option W R0 (BOOTSTRAP)
* PORT 1 ON  19200 L / (19200)
  PORT 2 OFF 19200  / (19200)
  PORT 3 OFF 19200  / (19200)
  PORT 4 OFF 19200  / (19200)
              SOFTWARE / (HARDWARE)
```

* indicates the Primary User.

3.6.3 'A' SET PRIMARY USERSteps:

- | | | |
|--------------------------|----------|----------------------|
| 1. Type | 'A' | |
| 2. Password (psw), type | 'MXEPSW' | (any six characters) |
| 3. Port designator, type | 'X' | (ports 1 through 3) |
| 4. Return | | |

Example: %AM012345

CRT DISPLAY: OK

The port designated has become the new primary user in the MVP mode.

3.6.4 'B' SET BAUD RATESteps:

- | | | |
|--------------------------|--------|-----------------------|
| 1. Type | 'B' | |
| 2. Password (psw), type | MXEPSW | (any six characters) |
| 3. Port designator, type | 'X' | (ports one through 3) |
| 4. Baud Rate, type | '1200' | (1200=example) |

Example: %BM0123451200

CRT DISPLAY: R0 (BOOTSTRAP)

```
* PORT 1 ON 19200 L / (19200)
  PORT 2 OFF 19200 / (19200)
  PORT 3 OFF 19200 / (19200)
  PORT 4 OFF 19200 / (19200)
Are you SURE?(Y/N): Y (answer Y or N)
OK
```

To ensure that the new baud rate is set properly, perform a '?' (STATUS) check. Refer to 2.5.2 (STATUS).

NOTE: Setting the baud rate through software overrides any hardware switch setting. Therefore, the baud rate desired is now set at the port designated.

3.6.5 'C' SET PASSWORDSteps:

- | | | |
|--------------------------------|----------|----------------------|
| 1. Type | 'C' | |
| 2. Password (psw), type | 'MXEPSW' | (any six characters) |
| 3. New Password (newpsw), type | 'NEWPSW' | (any six characters) |
| 4. Return | | |

IV.A.3

Example: %C012345EWPSW

CRT DISPLAY: C////////////////////
OK

'NEWPSW' becomes the new password.

3.6.6 'E' ANALOG LOOPBACK

Steps:

- | | | |
|--------------------------|----------|----------------------|
| 1. Type | 'E' | |
| 2. Password (psw), type | 'MXEPSW' | (any six characters) |
| 3. Port designator, type | 'X' | (ports 1 through 3) |
| 4. Return | | |

Example: %EM012345

CRT DISPLAY: ANALOG LOOPBACK SUCCESS
or
ANALOG LOOPBACK ERROR

The Analog Loopback Test takes approximately six seconds to run. This test answers in one of two states: SUCCESS or ERROR (failure). The Analog Test checks the local end of the communications link. This isolates the modem from the telephone line, and connects the transmitter output to the receiver input. This command will cause all I/O's at all ports to be temporarily suspended.

3.6.7 'F' DIGITAL LOOPBACK

Steps

- | | | |
|--------------------------|----------|----------------------|
| 1. Type | 'F' | |
| 2. Password (psw), type | 'MXEPSW' | (any six characters) |
| 3. Port Designator, type | 'X' | (ports 1 through 4) |
| 4. Return | | |

Example: %F0123451

CRT DISPLAY: DIGITAL LOOPBACK SUCCESS
or
DIGITAL LOOPBACK ERROR

Digital loopback is executed at the port designated. The loopback checks the information transferred from one modem to another. This transferred information consists of a 256 byte data pattern. If any malfunction occurs during this test, the operator prompt will display as 'DIGITAL LOOPBACK ERROR'. This test takes approximately eight seconds. During this command, all I/O at all ports will be temporarily suspended.

NOTE: The Digital and the Analog Loopback tests can only be utilized to test the designated Option W port by inserting the RS-232 loopback plug.

3.6.8 'I' MEMORY TEST

Steps:

1. Type 'I'
2. Password (psw), type 'MXEPSW' (any six characters)
3. Return

Example: %M01234

CRT DISPLAY: NO MEMORY ERROR
OR
MEMORY ERROR

The Memory Test tests the RAM in a nondestructive way. One of two prompts answer the Memory Test. 'NO MEMORY ERROR' indicates no catastrophic error; 'MEMORY ERROR' indicates a catastrophic error. This test divides the RAM into three 16K increments. As a result, should one or two of the three increments contain error, these errors can be stored and displayed. Although there will be no destructive damage to the memory, port activities will slow down during the memory test.

3.6.9 'L' LOCK

Steps:

1. Type 'L'
2. Password (psw), type 'MXEPSW' (any six characters)
3. Return

Example: %LM01234

CRT DISPLAY: BAUDRATE LOCKED

IV.A.3

This command locks the current baud rate of the port issuing it. No port may change the baud rate of a port which is locked. This command is a toggle. Each time it is issued, the state of the baud rate lock will be reversed.

To unlock the baud rate at the designated port, repeat steps, one through three, in the 'LOCK' command.

Example: %LM01234

CRT DISPLAY: BAUDRATE UNLOCKED

NOTE: During many of the preceding commands, the performance of the 7846 option W board will be impaired. That is, all three ports generally slow down to some extent. However, during the analog and the digital loopback diagnostic, ALL port I/O will cease until the loopback is completed. Therefore, when the loopback is performed, all users connected to the 7846 option W board should be notified that the option W board will not be functioning normally.

4.0 OPERATION

4.1 LED INDICATIONS

After approximately six seconds of powering-up, the LED located on the top of the 7846 option W board will give one of two indications.

A. LED EXTINGUISHES (BOARD PASS)

The LED extinguishes approximately six seconds after initial turn-on. This indicates that all of the 7846 option W board Power-Up tests have passed.

B. LED REMAINS ON (CATASTROPHIC FAILURE)

Whenever the LED remains lit for more than approximately six seconds, a catastrophic failure for the board is indicated. Perform diagnostic test or replace the option W board.

4.2 LOADING SOFTWARE

To operate the SVP option W, a new revision level of the operating system, Revision Level 2.4 MVP software, is required.

PRODUCT SERVICE NOTICE

DATE: 4/9/81

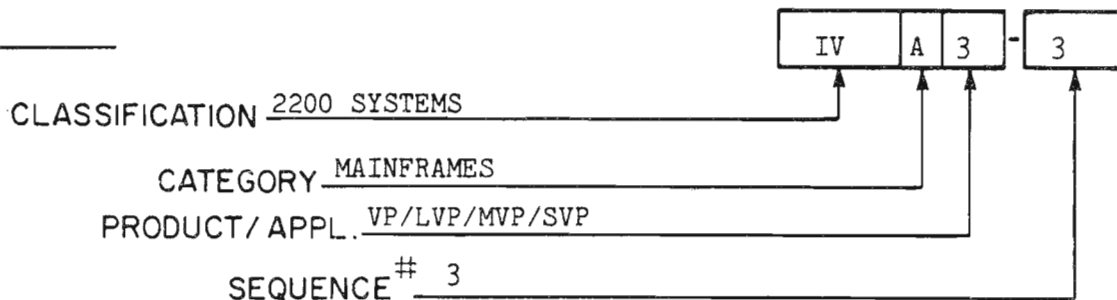

TITLE: 2200SVP: WL# 210-7890-A DUAL DISKETTE DRIVE CONTROLLER
-- SETTING DEVICE ADDRESS SWITCH SW1
-- PROM PART NUMBERS

A. SETTING DEVICE ADDRESS SWITCH (SW1)

Switch #8 in switchbank SW1 on the WL# 210-7890-A Dual Diskette Drive Controller must be set ON for normal operation of the diskette drive(s).

Correct the switch setting given on page 8-16 of the 2200SVP Computer Product Maintenance Manual, WL# 729-0863 (IV.A.3.MA-0), to reflect the information stated above.

B. PROM PART NUMBERS

The part numbers for the two PROM's on the WL# 210-7890-A Dual Diskette Drive Controller are: L14 = 378-6002; L15 = 378-4260. Add these two part numbers to Figure 8-11 on page 8-16 of 2200SVP Computer Product Maintenance Manual, WL# 729-0863 (IV.A.3.MA-0).



PRODUCT SERVICE NOTICE

DATE : 5/27/81

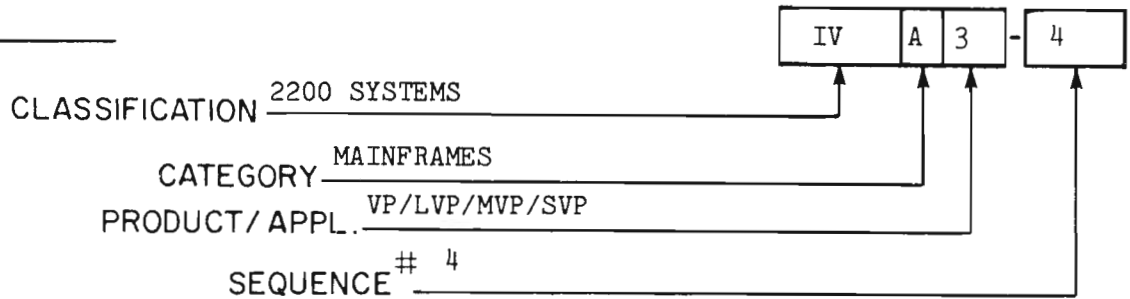

TITLE:

2200SVP: WL# 210-7890-A VCO ADJUSTMENT

This Notice documents the adjustment procedure for the voltage-controlled oscillator (VCO) on the WL# 210-7890-A Dual DSDD Diskette Drive Controller board in the 2200SVP Computer.

NOTE:

Adjustment of the VCO should only be performed by board-repair personnel. (For this reason, the potentiometer is glyptalled after the initial adjustment in manufacturing.) If the VCO is suspected of being out of adjustment, the Customer Engineer should simply replace the 210-7890-A board.

A. REQUIRED TOOLS/TEST EQUIPMENT

- 2200SVP Computer with one or two DSDD diskette drives.
- PLL adjustment utility program diskette (WL# 732-0003).
- Oscilloscope.
- Small slot screwdriver.
- Operating System diskette
- One DSDD diskette that can be formatted (work diskette).
- DSDD diskette that was formatted in a unit with a "reference" diskette controller board

B. INITIAL SETUP

Be certain the 2200SVP test unit is completely operational and the "reference" diskette is error free.

C. ADJUSTMENT PROCEDURE

NOTE:

- a) Remember to switch ac power OFF prior to removing/inserting any logic board from/into the test unit.
 - b) The Operating System does not have to be loaded to perform steps 1-4 following.
1. Connect the oscilloscope Channel 1 probe to TP2 (Test Point #2) on the 210-7890-A board (ref: FIGURE 1). IF 3 TEST PTS USE MIDDLE. ONLY 2 IN PICTURE
 2. Connect the oscilloscope ground lead to $\pm 0V$ on the 210-7890-A board (ref: FIGURE 1).

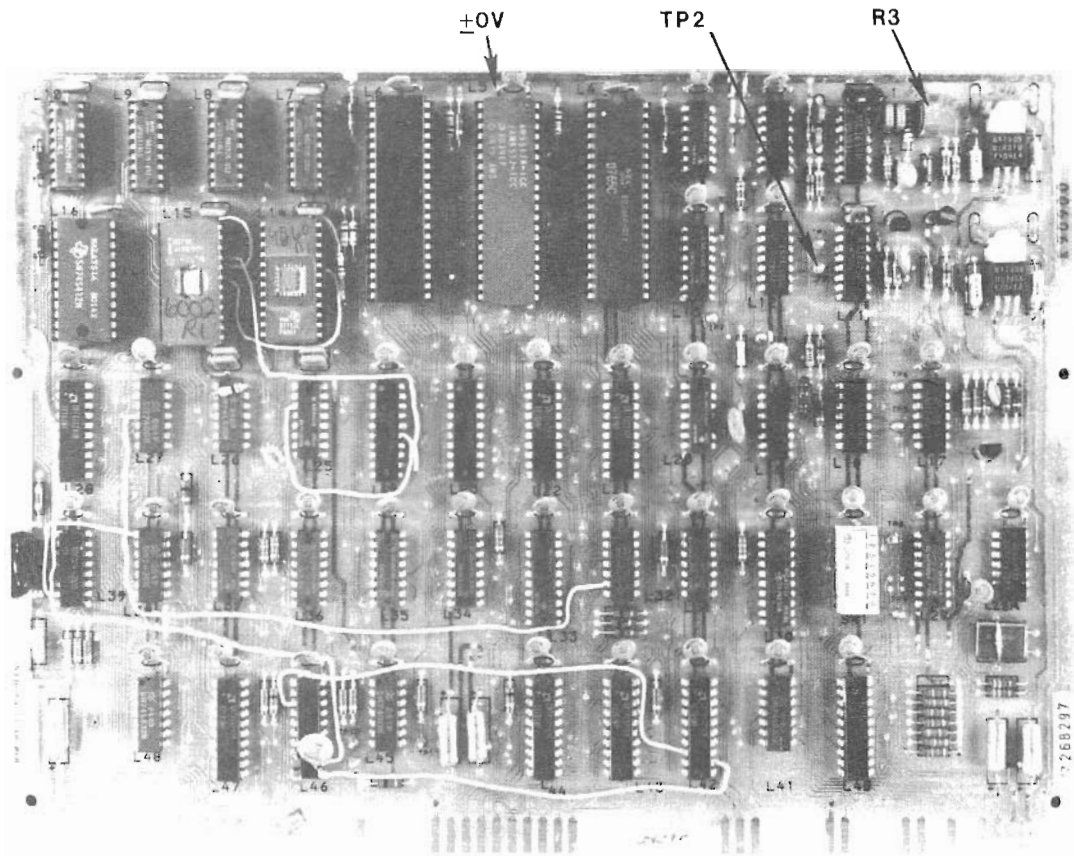

FIGURE 1 WL NO. 210-7890-A TEST POINT AND POTENTIOMETER

3. Set the oscilloscope controls as follows.

Display Mode: Channel 1
Trigger Source: Channel 1
Trigger Mode: Normal (dc coupling)
Trigger Slope: Positive
Time Base: 0.1 usec/div
Vertical Sensitivity: 2V/div
Input Coupling: dc

4. With ac power ON and the diskette drive in an idle state (i.e., not reading or writing), adjust potentiometer R3 until the period of the displayed waveform approaches 500 nsec. At approximately 490 nsec or 510 nsec, the signal will actually jump to a period of 500 nsec. When the signal "locks up" at 500 nsec, the VCO is adjusted properly (ref: FIGURE 2).

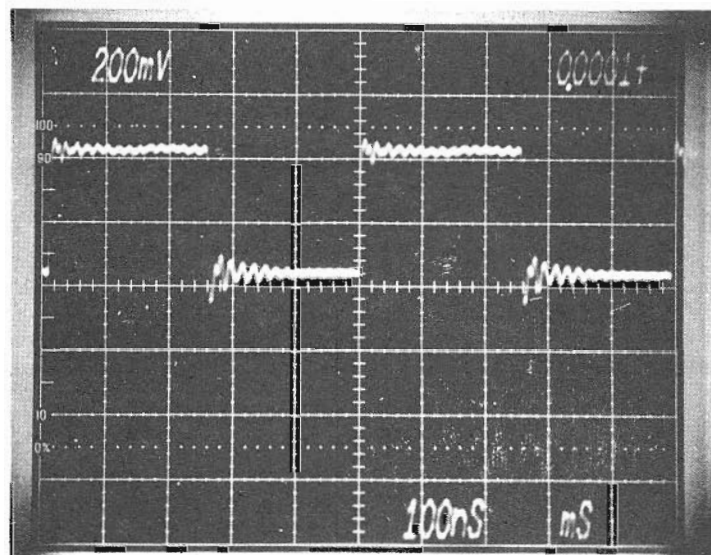

FIGURE 2 CORRECT VCO OUTPUT

5. Insert an Operating System (OS) diskette into the DSDD drive, load the OS, and then remove the diskette.
6. Insert a PLL adjustment utility program diskette (WL# 732-0003) into the DSDD drive.
7. Enter the following on the workstation keyboard to load the utility program, and then remove the diskette.

```

SELECT DISK 310 (B10 if applicable)
(RETURN)
LOAD T "2200 VCO"
(RETURN)

```

8. Insert a work diskette into the DSDD drive.

IV.A.3-4

- 9. Enter the following on the workstation keyboard to format the diskette.

```
$FORMAT DISK F (R if applicable)
(RETURN)
```

- 10. Depress RUN and then RETURN to start the utility program.
- 11. Enter the diskette drive address (normally D11) into the following screen prompt.

```

                                VCO Adjustment Rev. 8120
Enter the desired disk address  D10

```

The program automatically initiates a write sequence filling the last four tracks on the diskette with zeros (see sample screenload below).

```

                                VCO Adjustment Rev. 8120
                                on D11 DSDD Drive

n Passes   n Errors
*****
*****
-----
0 % ..... 25% ..... 50% ..... 75% ..... 100 %

Writing an all zeros pattern.

```

After the write operation is complete, the program initiates a read routine. The pass count and error count are displayed above the bar graph on the screen. If a read error occurs, the error code and the sector where the error was detected are also displayed above the bar graph (see sample screenload below). (Depressing the CLEAR key resets the pass and error counts.)

```

                                VCO Adjustment Rev. 8120
                                on D11 DSDD Drive

n Passes   n Errors                               last error= I-9n for sector nnnn
*****
*****
-----
0 % ..... 25% ..... 50% ..... 75% ..... 100 %

Verifying an all zeros pattern.

```

- 12. Be certain no read errors occur.

13. Depress the LOAD key to write and then read a worst case data pattern on the last four tracks of the diskette.
14. Once again be certain no read errors occur.
15. Observe the VCO output signal displayed on the oscilloscope. When the VCO is adjusted properly, the displayed waveform will be stable with no shifting or jittery edges (ref: FIGURE 3).
16. Depress the HALT key to stop the utility program.
17. Insert the "reference" diskette into the test unit drive and enter the following on the workstation keyboard.

```
VERIFY R (0,3873)  
(EXECUTE)
```

(If the VERIFY operation is completed error free, the VCO adjustment is correct. If any errors are detected, readjust the VCO.)

18. Glyptal the potentiometer to prevent any change in the adjustment.

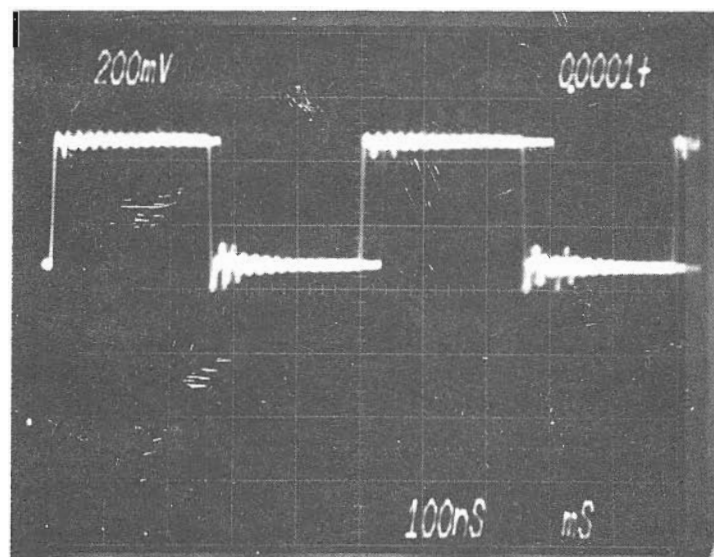

FIGURE 3 INCORRECT VCO OUTPUT

PUBLICATION UPDATE BULLETIN

DATE: 03/16/84

This PUB:

Class Code: 4103

Base Documents: 729-0602-A and 729-0935-A

Previous Notice(s):None

This Publication Update Bulletin (PUB) documents the phase-lock-loop (PLL) adjustment procedure for the 210-8694/8794 board in the 2200LVP/SVP Disk Processing Unit (DPU). The adjustment procedure in this PUB supercedes the one in Section 11.3 of the Model 2200LVP Product Maintenance Manual (729-0602-A). This PUB also serves as an addendum to the 2200SVP Product Maintenance Manual (729-0935-A).

WANG

LABORATORIES, INC

ONE INDUSTRIAL AVENUE, LOWELL, MASSACHUSETTS 01851, TEL. (617) 459-5000, TWX 710 343-6769, TELEX 94-7421

PRINTED IN U.S.A.

A. REQUIRED TOOLS/TEST EQUIPMENT

- PLL Adjustment Utility Program diskette (732-0009B)
- Oscilloscope
- DVM
- Small slot screwdriver
- Short length of jumper wire
- Operating System diskette
- One DSDD work diskette
- Two DSDD diskettes that were formatted in two different units other than the unit under test)

B. INITIAL DIAGNOSIS

This PLL adjustment procedure is presented in three parts. The CE must first determine the extent of the adjustment required and then perform the recommended procedure(s) as follows:

Adjustment Procedures 1, 2 and 3 must be performed to correct a major problem such as a Winchester disk drive completely out of adjustment, or lack of communication between the Disk Processing Unit (DPU) and either or both drives.

Adjustment Procedure 2 is used to "fine tune" the DPU in cases where communication does exist between the DPU and its drives; however, random errors may occur from time to time.

Adjustment Procedure 3 is the Verify Winchester While Suppressing Retries Test and the Alternate Sectors Test. These tests are presented to aid the CE in diagnosing problems associated with the Winchester disk drive itself.

CAUTIONS

1. Be certain the "reference" diskettes are error free. Whenever possible, use fresh diskettes from stock - do not use diskettes formatted in the field.
2. Diskette 732-0009B and Operating System 2.5 (or greater) will have a pre-written worst-case pattern on the inner two tracks for use in floppy drive adjustments. Do not write on these tracks.
3. Switch ac power OFF prior to removing/inserting any logic board from/into the unit.
4. The Operating System does not have to be loaded in to perform any of the steps given in Adjustment Procedure 1.
5. All references to test points, IC pins, potentiometers, etc. pertain to the 210-8694 board (see figure 1).
6. Wires inserted into plate-through holes are available on the noncomponent side of the board to connect the oscilloscope probe to when performing steps 7 and 8 of Adjustment Procedure 1.

C. ADJUSTMENT PROCEDURE 1 (Coarse Adjustment)

1. Using a jumper wire, connect TP1 (Test Point #1) to +0V (GND).
2. Set the DVM (or oscilloscope) controls to measure +4.00V dc.
3. Connect the DVM (or oscilloscope) ground probe to +0V (GND).
4. Connect the DVM (or oscilloscope) signal probe to L5 pin 1 or 2.
5. Adjust potentiometer R16 for a +4.00V dc indication.
6. Carefully remove the jumper wire from TP1.
7. Connect both oscilloscope probe ground leads to +0V (GND).
8. Connect oscilloscope Channel 1 (or A) probe to L8 pin 11 (phase detector reference clock).
9. Connect oscilloscope Channel 2 (or B) probe to L4 pin 6 (voltage controlled oscillator-VCO-output).

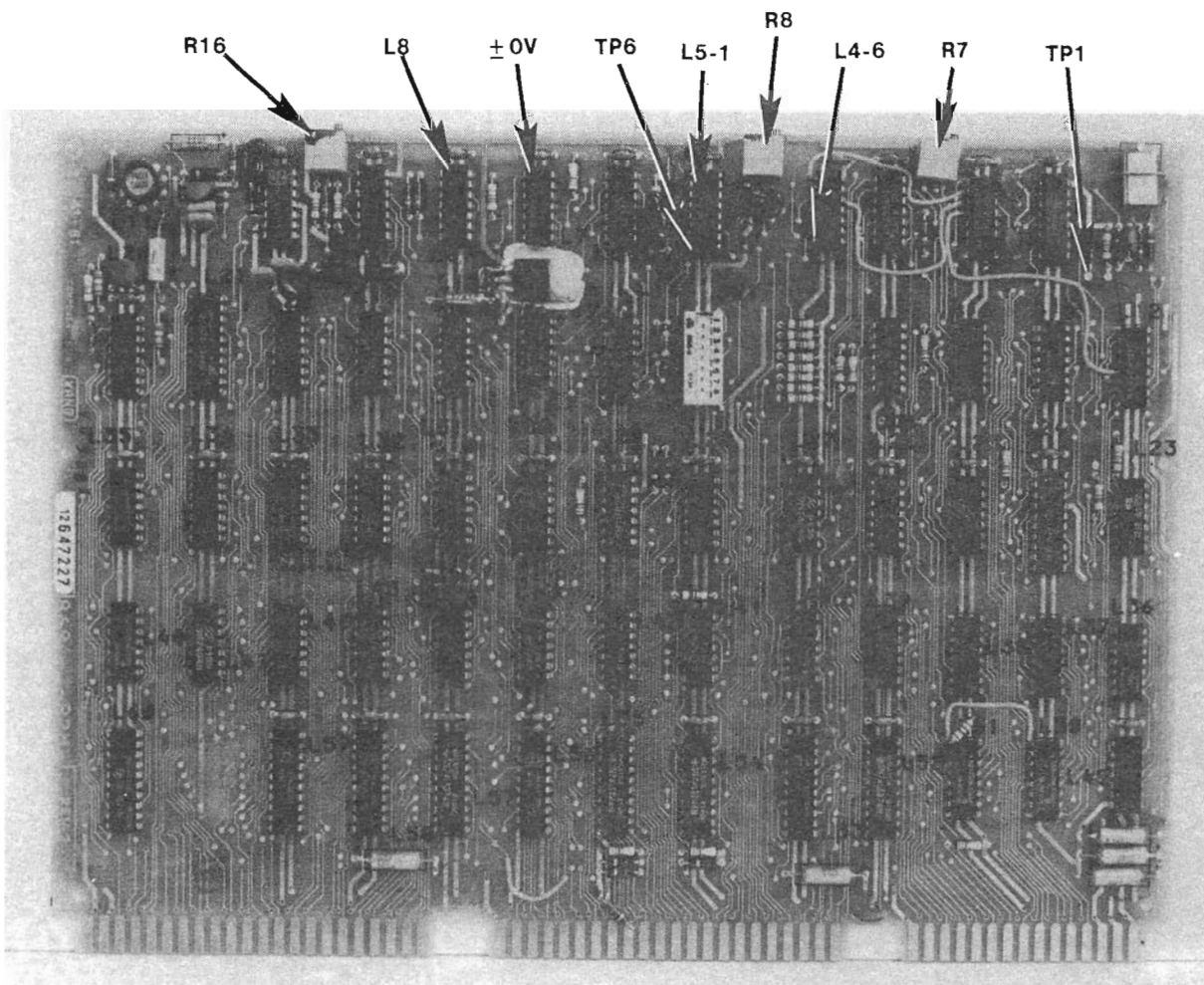

B-01311-FY84-1

FIGURE 1 WL NO. 210-8694 TEST POINTS AND POTENTIOMETERS

10. Set the oscilloscope controls as follows.

Display Mode: Alternate
Trigger source: Channel 1 (or A)
Trigger Mode: Normal (dc coupling)
Trigger Slope: Positive
Time Base: 0.1 usec/div
Vertical Sensitivity: 2V/div
Input Coupling: dc

11. Adjust potentiometer R7 (Winchester drive adjustment) as follows:

CAUTION

The shaft of potentiometer R7 may be secured tight with Glyptol. Do not try to remove the Glyptol; instead gently rotate the shaft of R7 back and forth to loosen it.

- a. Turn R7 completely counterclockwise (as evidenced by the indent "click" heard once during each rotation of R7 when it is at that stop).

NOTE

It may require as many as 20 turns of R7 to reach the indent.

- b. Turn R7 slowly clockwise until the VCO output signal (Channel 2 or Channel B) is stable--not free running.
- c. Continue adjusting R7 clockwise until all the VCO output pulses are centered with respect to the phase detector reference clock pulses (see figure 2). When this condition occurs, the PLL is "locked". When the output pulses are centered, the VCO output pulse period will be approximately 0.115 usec (figure 2).

NOTE

Figure 3 shows an incorrect VCO output signal. Note that the higher frequency of the VCO output in the figure results in an extra pulse (ten instead of nine) in the VCO output.

- d. If necessary, repeat step 11 several times to ensure proper adjustment.

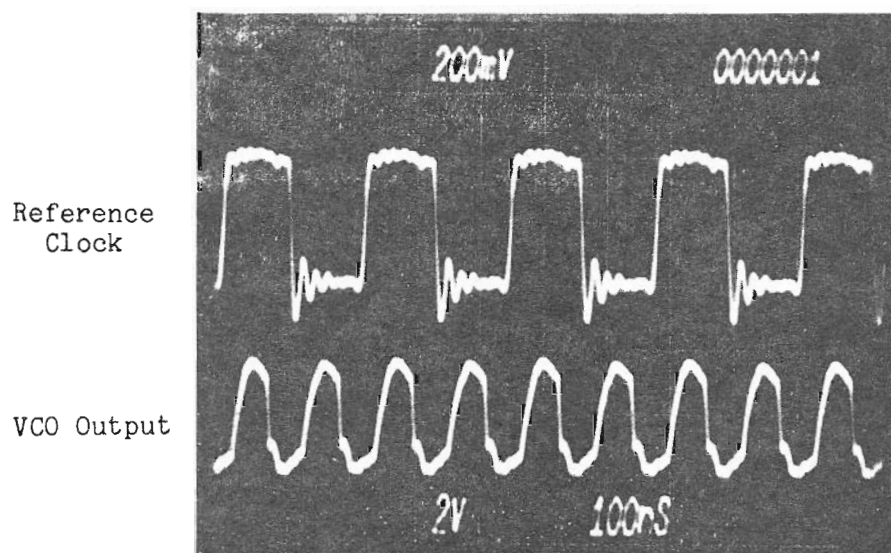

FIGURE 2 PLL CORRECTLY ADJUSTED FOR WINCHESTER DISK DRIVE

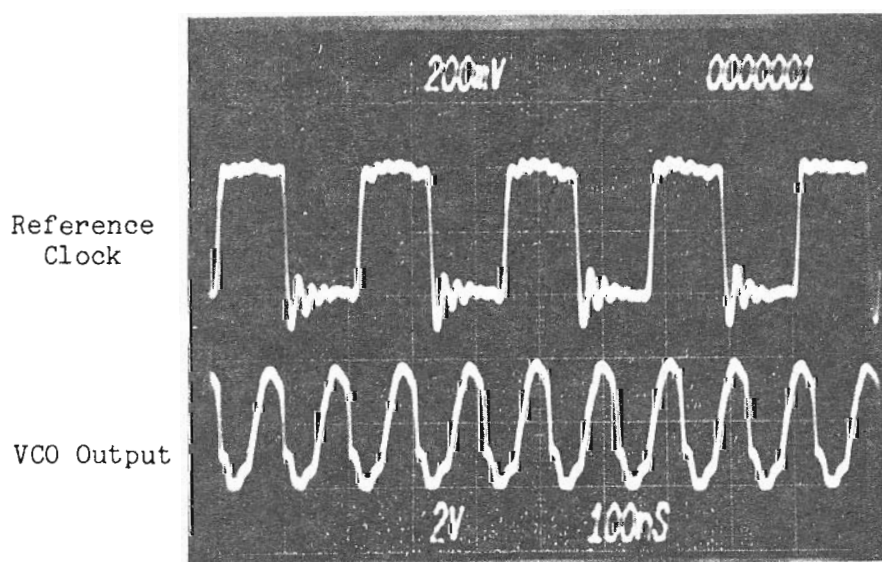

FIGURE 3 PLL INCORRECTLY ADJUSTED FOR WINCHESTER DISK DRIVE

12. Verify that the adjustment is correct by connecting a jumper from TP6 to +0V (GND) and then removing the wire. This momentarily selects the diskette drive frequency. The PLL should "lock back up" on the Winchester disk drive frequency (figure 2) when the jumper is removed as indicated by the VCO output automatically returning to a stable, not free-running state. If the PLL does not "lock up" (figure 4), continue adjusting R7 in the clockwise direction until the conditions in step 11 are met and the PLL "locks up".

NOTE

If Necessary, repeat step 12 several times to ensure proper adjustment.

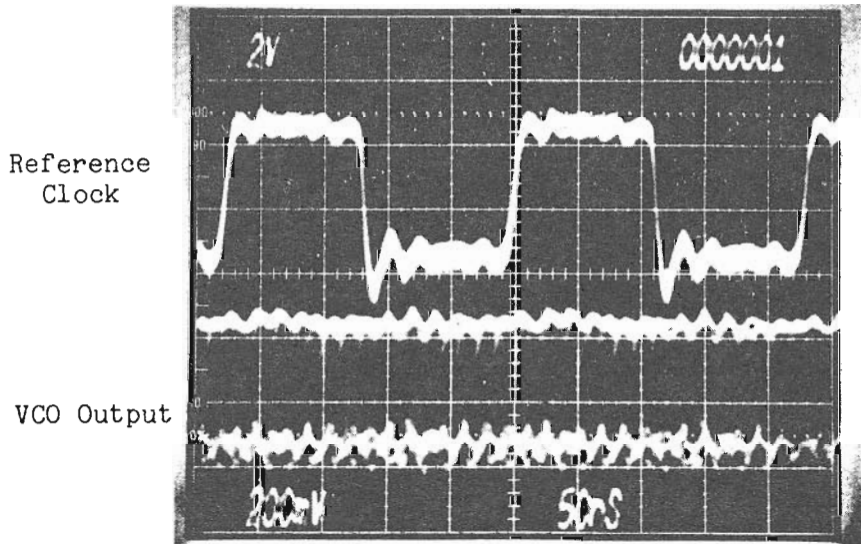

FIGURE 4 PLL NOT "LOCKED"

13. Again verify that the adjustment is correct by setting the CPU ac power switch OFF and then back ON. After setting the power ON, note the actions of the actuator damper on the Winchester disk drive. (The damper is a 3-inch cylinder mounted on the narrow side of the drive and distinguished by a yellow CAUTION sticker). The actuator should restore the heads to track 0 and then position the heads at the last track. If any retries occur, that is a restore operation and re-seek to the last track, continue adjusting R7 in the clockwise direction until the conditions in steps 11 and 12 are met and no retries occur as stated above.
14. Select the diskette drive frequency by connecting a jumper between TP6 and +0V (GND).
15. Slowly adjust potentiometer R8 (diskette drive adjustment) until the leading edge of the VCO output pulse (Channel 2) occurs 0.075 usec after the leading edge of the phase detector reference clock as shown in figure 5. Figures 6 and 7 show incorrect VCO output signals.
16. Carefully remove all jumpers. Power the system down.

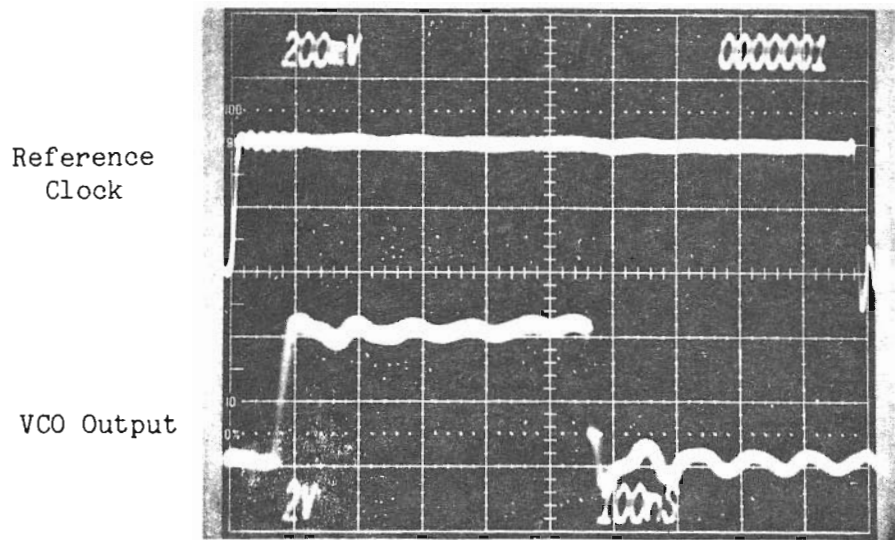

FIGURE 5 PLL CORRECTLY ADJUSTED FOR DISKETTE DRIVE

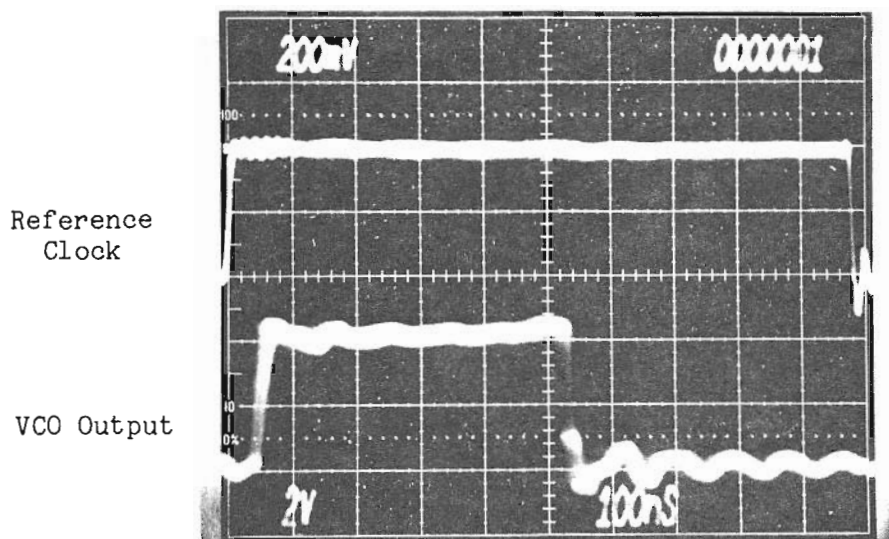

FIGURE 6 PLL INCORRECTLY ADJUSTED FOR DISKETTE DRIVE

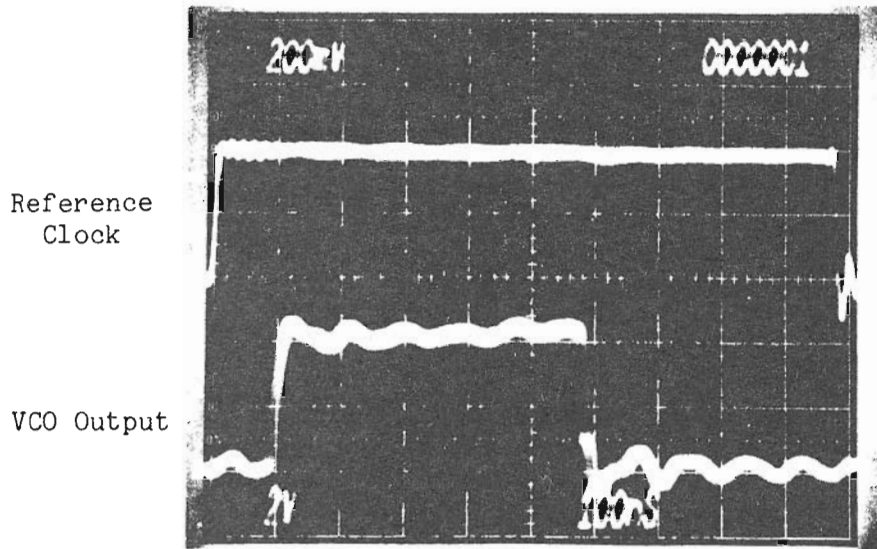

FIGURE 7 PLL INCORRECTLY ADJUSTED FOR DISKETTE DRIVE

D. ADJUSTMENT PROCEDURE 2 ("Fine Tuning")

1. Power the system down for approximately 30 seconds and then power it back up.
2. Insert an Operating System (OS) diskette into the DSDD drive, load the OS, and then remove the diskette.

CAUTION:

BEFORE CONTINUING WITH THE "FINE TUNING" ADJUSTMENT PROCEDURE, BACKUP ALL CUSTOMER DATA RESIDING ON THE WINCHESTER DISK DRIVE.

3. Insert a PLL adjustment utility program diskette 732-0009A (or B) into the DSDD drive.
4. Enter the following routine on the workstation keyboard to load and run the utility program. If running Utility 732-0009A, remove the diskette from the drive. If running Utility 732-0009B, leave the diskette in the drive. Observe the display shown at the top of the next page.

```

SELECT DISK B10
(RETURN)
LOAD RUN
(RETURN)

```

LVP PHASE LOCK LOOP PROGRAM

KEY SF' 16 TO RETURN TO MENU

SF'0 - FORMAT PLATTERS
 SF'1 - ADJUST FLOPPY
 SF'2 - ADJUST WINCHESTER
 SF'3 - WRITE FLOPPY INNER TRACKS WITH HEX (0B6DB6)
 SF'4 - WRITE FLOPPY INNER TRACKS WITH HEX (015AA5)
 SF'5 - WRITE FLOPPY INNER TRACKS WITH HEX (0B6DB6)(015AA5)
 SF'6 - WRITE WINCHESTER INNER TRACKS WITH HEX (0B6DB6)(015AA5)
 SF'7 - VERIFY WINCHESTER SUPPRESSING RETRIES.
 SF'8 - ALTERNATE SECTORS TEST

STOP KEY DESIRED SPECIAL FUNCTION KEY

: _

5. While observing the screen, select Special Function Key 6 (SF'6) to write on inner tracks of the Winchester. The message below appears quickly during the time that the worst-case data pattern is being written on the last two (inner) tracks of the disk.

WRITING WORST CASE PATTERN FROM LOCATION xxxxxx TO LOCATION xxxxxx

6. Observe that after the data is written, the primary menu is again displayed on the screen.
7. Select SF'2 from the primary menu.
8. Key RETURN in response to the following prompt.

LVP PHASE LOCK LOOP PROGRAM

KEY SF'16 TO RETURN TO MENU

KEY RETURN WHEN READY TO ADJUST WINCHESTER

The program will now initiate a continuous read operation on the last two tracks of the disk and display a single period (.) upon successful completion of each read operation (partial program shown on the following page). If an error occurs, no retries are performed, and an error message is displayed instead of a period.

LVP PHASE LOCK LOOP PROGRAM

KEY SF'16 TO RETURN TO MENU

ADJUSTING WINCHESTER.....

9. Adjust potentiometer R7 to the midpoint of its "error-free range" as follows:
 - a. Rotate R7 until only dots appear on the screen. Allow at least one line of dots to appear without any errors.
 - b. Rotate R7 counterclockwise until errors are observed. Then rotate R7 clockwise stopping at the point that errors subside. Allow at least one line of dots to appear without any errors.
 - c. Count the number of half-turns and rotate R7 clockwise until errors are observed.
 - d. Count the number of half-turns and rotate R7 counterclockwise until the errors subside.
 - e. Subtract the number of half-turns counted in step d from that in step c. If this difference is less than three half-turns (1-1/2 turns), replace the board.
 - f. Divide the difference recorded in step e by two. Turn R7 counterclockwise this number of half-turns.

NOTE

Adjustment of the PLL for the
 Winchester Drive is now complete.

10. Key SF'16 to return to the primary menu.
11. If running Utility 732-0009A, Insert a 2.5 (or higher) operating system diskette into the DSDD drive.
12. Select SF'1 from the primary menu.
13. Key RETURN in response to the following prompt.

LVP PHASE LOCK LOOP PROGRAM

KEY SF'16 TO RETURN TO MENU

MOUNT TEST PLATTER IN FLOPPY
 KEY RETURN TO CONTINUE

The program will now initiate a continuous read operation on the last two (inner) tracks of the diskette and display a period (.) upon successful completion of each read operation (partial program shown on screen display below). If an error occurs, no retries are performed and an error message is displayed instead of a period.

```
LVP PHASE LOCK LOOP PROGRAM
```

```
KEY SF'16 TO RETURN TO MENU
```

```
ADJUSTING FLOPPY.....
.....
```

14. Adjust potentiometer R8 to the midpoint of its "error-free range" as follows:
 - a. Rotate R8 until only dots appear on the screen. Allow at least one line of dots to appear without any errors.
 - b. Rotate R8 counterclockwise until errors are observed. Then rotate R8 clockwise stopping at the point that errors subside. Allow at least one line of dots to appear without any errors.
 - c. Count the number of half-turns and rotate R8 clockwise until errors are observed.
 - d. Count the number of half-turns and rotate R8 counterclockwise until the errors subside.
 - e. Subtract the number of half-turns counted in step d from that in step c. If this difference is less than three half-turns (1-1/2 turns), replace the board.
 - f. Divide the difference recorded in step e by two. Turn R8 counterclockwise this number of half-turns.
15. Key SF'16 to return to the main menu.
16. Insert a blank or scratch work diskette into the DSDD Drive.
17. Re-run the adjustment utility program selecting SF'0 from the primary menu to format the work diskette. Observe that the following menu is displayed after SF'0 is keyed.

```
LVP PHASE LOCK LOOP PROGRAM
```

```
KEY SF'16 TO RETURN TO MENU
```

```
FORMAT WHICH PLATTER? (F - FIXED OR R - REMOVABLE)
```

CAUTION

DO NO CONTINUE THIS PROGRAM IF CUSTOMER DATA RESIDES
ON THIS DISK. PLEASE INSTALL A SCRATCH FLOPPY DISK.

18. Enter R an then key RETURN to format the diskette.

When the format operation is complete, the program automatically writes a worst case data pattern on the last two inner tracks of the diskette. (An option is available from the primary menu to write worst case data on the inner tracks without having to format the diskette.)

19. Select SF'1 from the primary menu. Observe the following prompt.

```

LVP PHASE LOCK LOOP PROGRAM

KEY SF'16 TO RETURN TO MENU

MOUNT TEST PLATTER IN FLOPPY
KEY RETURN TO CONTINUE

```

20. Key RETURN and observe following prompt.

```

LVP PHASE LOCK LOOP PROGRAM

KEY SF'16 TO RETURN TO MENU

ADJUSTING FLOPPY.....
.....

```

21. Allow the program to run a minimum of 15 minutes and observe two full screens of dots. If an error occurs before two full screens are filled up with dots, repeat step 14 to re-adjust potentiometer R8.

NOTE

If errors still occur after a second adjustment
of R8, troubleshoot the disk system.

22. To test diskette interchangeability, obtain two known good diskettes formatted and written on from other systems (not the system under test) known to be operating properly.
23. Insert one diskette into the test system and run the VERIFY check on it using the sequence given below. Repeat for the second diskette.

```

VERIFY R (0, 3873)
(RETURN)

```

24. No errors should be listed on the screen. If any are, repeat step 14. If any are listed after the second adjustment, troubleshoot the disk system.

NOTE

Adjustment of the PLL for the
DSDD Drive is now complete.

E. ADJUSTMENT PROCEDURE 3

This adjustment procedure consists of two separate tests designed to help the CE diagnose Winchester disk drive problems. The first is the Verify Winchester Suppressing Retries Test and the second is the Check Alternate Sector Test.

The Winchester Suppressing Retries test is used where intermittent I93 and I96 errors occur and a standard verify test does not show any bad sectors. The Winchester Suppressing Retries test will produce a dot on the CRT each time the Winchester drive makes a complete verification (one pass) of the disk surface. A bad sector is indicated if the same sector address occurs more than three times in 25 passes. If a sector address is suspected of being bad, a disk reformat is required.

The Check Alternate Sector Test is used in two ways. First to verify that a marginal sector does get an alternate sector assigned after formatting. Second to determine if a Winchester drive has an excessive number of alternate sectors. If a disk surface has in excess of 25 alternate sectors, a phase-lock-loop adjustment along with a reformat should be performed.

The step-by-step procedure for executing the Winchester Suppressing Retries Test and the Alternate Sectors Test is as follows:

1. Load Utility Program 732-0009B.
2. Select Special Function #7 and allow the program to run a minimum of 30 minutes.
3. Observe that a dot appears on the screen each time one verification pass of the Winchester drive is completed.
4. Record all errors reported. If the same error (sector address) is reported more than three times in 25 test passes (25 dots), the CE should:
 - a. Perform steps 1 through 9f of Adjustment Procedure 2.
 - b. Backup all customer data.
 - c. Reformat the Winchester.

5. Select SF'16 to return to the main menu. Select Special Function #8 (Alternate Sector map) and observe following prompt:

```

WINCHESTER ALTERNATE SECTOR MAP DISPLAY
KEY RETURN FOR MAIN MENU
DRIVE ADDRESS D

```

6. Input the drive address (D11, D12, D21, D22, D31 or D32).
7. Key RETURN and observe the alternate sector map for listing of bad sectors (sector appearing 3 or more times is considered bad) as follows:

ALTERNATE MAP FOR PLATTER D11

WANG SECTOR #	WINCHESTER				
	CYLINDER	HEAD	SECTOR	START BYTE	END BYTE

(Bad Sectors)

.
.
.
.
.

END OF THE LIST - HIT ANY KEY TO RUN AGAIN

8. Carefully verify that any sector address (error) reported three or more times in step 4 (Special Function #7) is also reported in the Alternate Sector map (after re-formatting Winchester drive).

NOTE

Other addresses not reported three or more times in SF'7 may appear in the Alternate Sector map.

9. Re-run steps 1 through 4 to verify correct Winchester Drive operation.

NOTE

No error should be listed more than two times on the screen. If any error is listed more than twice after the second adjustment, troubleshoot the disk system.

(WANG) FIELD CHANGE ORDER

FCO NO.
1006

Equipment Affected 2200 SVP-A/X (SINGLE BOARD CONTROLLER)

Class NEXT CALL FCO Kit # 728-0012 Page 1 of 4

Org. Code IV.A.3 FCO Doc. # 729-1092 Approval Date:

Est. Install. Time ONE HOUR Ref. ECO # 21865 JUN 1 1982

1. REASON FOR CHANGE

A. This version of Single Board Controller Microcode is designed and verified to fix the following problems:

- * IBM routine was modified to correct the record handling capabilities.
- * DATASAVE BA function was modified to correct the I98 or I94 errors.
- * The disk format operation was modified to correct improperly reported format errors that may occur on the 26th sector.

B. Enhancements:

- * The cache capacity was increased to improve the speed of sequential reads and sequential writes.
- * Improvements were made to increase verify speed.
- * RAM integrity is checked by background memory diagnostic.

2. DESCRIPTION OF CHANGE

To update the EPROM's of the 210-7890-A board with 378-6002-R2 (L15) and 378-4260-R2 (L14) EPROM's.

3. DOCUMENTATION AFFECTED

N/A

Product Support <u>AMR</u> 6/1/82	Logistics <u>Kevin Sanders</u> 6/1/82	Originator <u>Elaire Donald</u> 6/1/82	FCO Coordinator <u>John Prosky</u> 6/1/82
--------------------------------------	--	---	--

(WANG) FIELD CHANGE ORDER

FCO NO.

1006

Equipment Affected 2200 SVP-A/X (SINGLE BOARD CONTROLLER)Class NEXT CALLFCO Kit # 728-0012Page 2 of 4Org. Code IV.A.3FCO Doc. # 729-1092

Approval Date:

Est. Install. Time ONE HOURRef. ECO # 21865**JUN 1 1982**

4. PREREQUISITE (S)

- A. The updated EPROM's must be used with VP O/S Rev 2.4 or higher.
- B. This change need only be installed on the 2200 SVP-A/X model consisting of one or two DSDD floppy disks with a single board controller (210-7890).
- C. The 210-7890-A should be at E-Rev 4 before installation of this change.

5. INSTALLATION PROCEDURE

CAUTION:

THIS CHANGE INVOLVES DEVICES THAT CAN BE DEGRADED OR DESTROYED BY ELECTRO-STATIC DISCHARGE (ESD). TO INSURE OPTIMUM/RELIABLE EQUIPMENT OPERATION, IT IS REQUIRED THAT TECHNICAL SUPPORT PERSONNEL DISCHARGE THEMSELVES BY PERIODICALLY TOUCHING THE CHASSIS GROUND PRIOR TO AND DURING THE HANDLING OF SUCH DEVICES.

- A. Ensure power is off. Remove the top cover of the 2200 SVP.
- B. Remove the 210-7890-A board.
- C. Remove EPROM's from locations L15 and L14.
- D. Replace EPROM's with 378-6002-R2 (L15) and 378-4260-R2 (L14) updated EPROM's. NOTE THE LOCATIONS OF PIN 1.
- E. Reinsert the 210-7890-A board into 2200 SVP unit.
- F. Run check-out procedures (See Section 6).
- G. Turn off power and reinstall the top cover.

WANG

FIELD CHANGE ORDER

FCO NO.
1006

Equipment Affected 2200 SVP-A/X (SINGLE BOARD CONTROLLER)

Class NEXT CALL FCO Kit # 728-0012 Page 3 of 4

Org. Code IV-A.3 FCO Doc. # 729-1092 Approval Date:

Est. Install. Time ONE HOUR Ref. ECO # 21865 **JUN 1 1982**

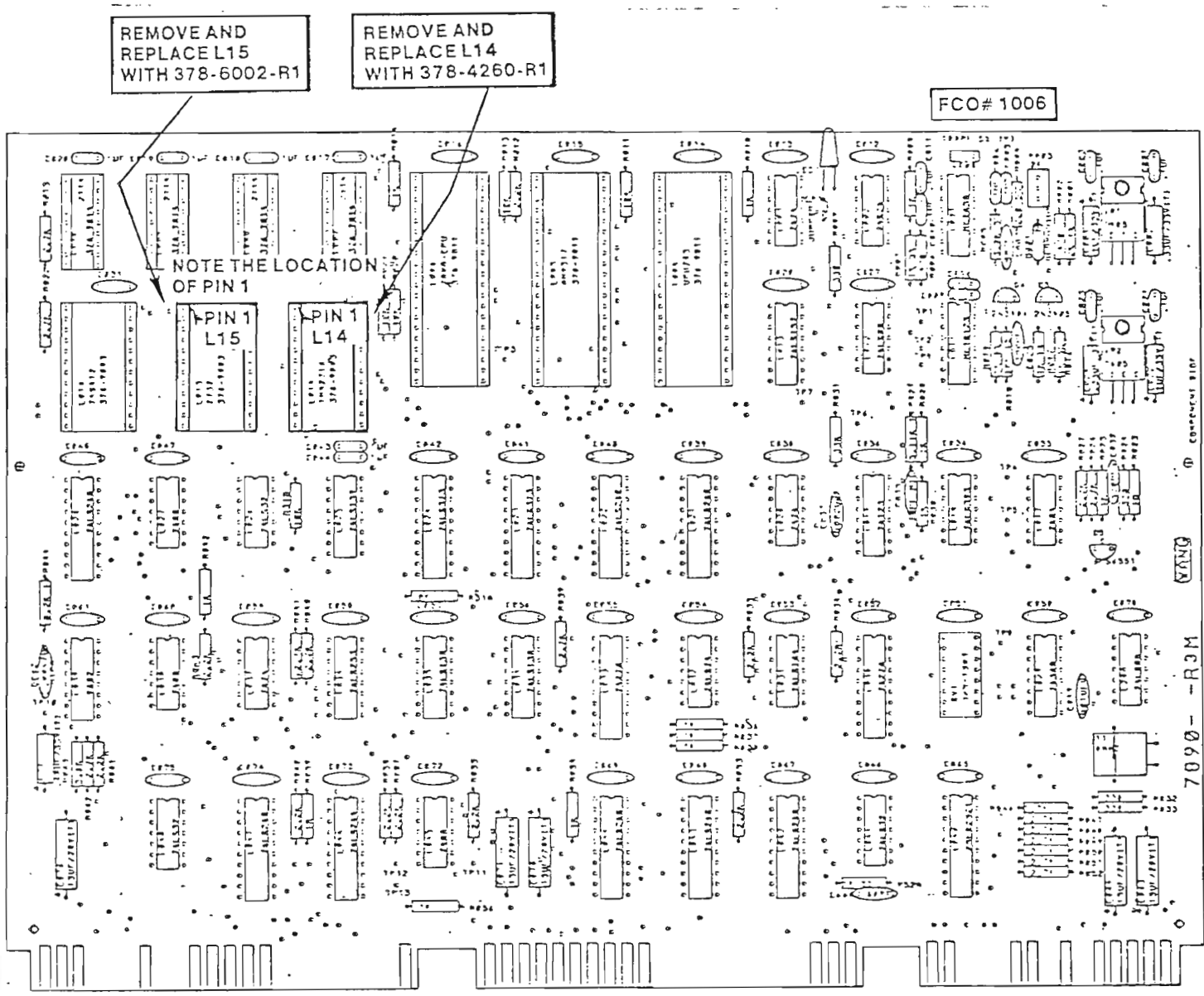

210-7890

7090 - R3M
WANG
© COPYRIGHT 1978

Equipment Affected 2200 SVP-A/X (SINGLE BOARD CONTROLLER)

Class NEXT CALL FCO Kit # 728-0012 Page 4 of 4

Org. Code IV.A.3 FCO Doc. # 729-1092 Approval Date:

Est. Install. Time ONE HOUR Ref. ECO # 21865 **JUN 1 1982**

6. CHECK-OUT PROCEDURE

- A. Turn on the 2200 SVP unit and ensure that the DPU passes power-up diagnostics.
- B. Run general disk exerciser WL# 732-0008A.

7. FCO KIT PARTS LISTING

Item #	Item Description
729-1092	FCO# 1006
378-6002-R2	2732 EPROM
378-4260-R2	2716 EPROM

8. FCO KIT AVAILABILITY DATE

FCO Kit# 728-0012 will be available June 16, 1982. It can be obtained by placing a routine order through the Logistics Order Processing system.

9. REMOVED PARTS DISPOSITION

Recycle removed EPROM's through your FSC.

10. MISCELLANEOUS

N/A



FIELD CHANGE ORDER

FCO NO.
1056

Equipment Affected SVP

Class Problem Only FCO Kit# 728-0074 Page 1 of 9

Org. Code 4103 (IV.A.3) FCO Doc. # 729-1355 Approval Date: **NOV 14 1983**

Est. Install. Time 1 Hour Ref. ECO # 28501

1. REASON FOR CHANGE

- A. To reduce the audible noise level of the unit.
- B. To increase cooling of the diskette drive.

*note B
FYE
Pml*

2. DESCRIPTION OF CHANGE

- A. The unit's 100 CFM fan is replaced by a 90 CFM fan.
- B. Plastic fan guards are replaced by metal fan guards.
- C. Two heatsink spacers are added to the heatsink.

3. DOCUMENTATION AFFECTED

"Customer Engineering Product Maintenance Manual SVP Computer," 729-0935, henceforth referred to as the "manual."

4. PREREQUISITE (S)

N/A

5. INSTALLATION PROCEDURE

- A. Power down the unit. Remove AC plug from wall.
- B. Refer to Figure 1. Using a Phillips screw driver, remove the six screws securing the sides of the cover (three on each side of the unit) and the two screws securing the cover at the rear of the chassis. Slide the cover toward the front of the unit and then lift the cover off.
- C. Refer to Figure 2. Remove the AC power plug from the plastic muffin fan at the rear of the chassis.
- D. Refer to Figure 1. Remove the muffin fan from the unit. To do this, take out the four screws, (650-3240) and lock nuts (652-0032) of the rear fan guard. Save the four screws and lock nuts to secure the new fan guard to the chassis in Step G below.

Tech Ops <i>11/11/83</i> <i>[Signature]</i>	Logistics <i>11/11/83</i> <i>Kevin Sanders</i>	Originator <i>11/10/83</i> <i>Mary Keady</i>	FCO Coordinator <i>John Rowley 11/10/83</i>
--	---	---	--

- E. Remove the four screws (650-3240) and lock nuts (652-0032) from the front fan guard of the muffin fan. Save the four screws and lock nuts for use in Step F.
- F. Refer to Figure 3. Insert four 6-32x3/4 screws (650-3240), saved from Step E, through four #6 flat washers (653-3000). Fasten one of the new fan guards (400-9016) to the front of the new 90 CFM tubeaxial fan (400-1031) with the four screws and four lock nuts (652-0032) saved from Step E.

NOTE: When fan guards are properly installed, there is a space between the fan guard grill and the fan. If the fan guard grill is flush to the fan, it has been installed backwards and should be reversed.

- G. Refer to Figure 4. Insert four 6-32x3/4 screws (650-3240), saved from Step D, through four #6 flat washers (653-3000). Install the 90 CFM tubeaxial fan (400-1031) and the remaining fan guard (400-9016) on the rear panel of the chassis. To do this, hold the fan against the inside of the rear panel. When properly placed, the air flow indicator on the fan is at the top of the unit. Secure the fan by installing the fan guard on the outside of the rear chassis panel using the four screws and four lock nuts (652-0032) saved from Step D.

NOTE: The air flow from the fan blows out of the chassis.

- H. Connect the AC power plug, shown in Figure 2, to the fan.
- I. Remove the diskette drive from the chassis using the procedures described in Section 11.6.3 of the manual.
- J. Using a Phillips screwdriver, remove the four screws that secure the heatsink to the chassis. This will also result in removal of the heatsink harness guard shown in Figure 5. (Some older units may not have a heat sink harness guard).

Refer to Figure 5 for Steps K-M.

- K. Place a #6 flat washer (653-3000) on each of two 6-32x5/8 screws (650-3207). Position a heatsink spacer (462-0485) between the top of the heatsink and inside the chassis. Fasten the screws through the chassis wall, heatsink spacer and tap holes in the heatsink assembly. (Keep the screws loose to allow space for installation of the bottom heatsink spacer in Step L below).

- L. Place a #6 flat washer (653-3000) on each of two 6-32x3/4 screws (650-3247). Position the remaining heatsink spacer (462-0485) between bottom of heatsink and inside chassis wall. Position the heatsink harness guard in its original location. Fasten the screws through the heatsink harness guard, chassis wall, heatsink spacer and tap holes in the heatsink assembly.
- M. Tighten the 6-32x5/8 screws (650-3207) installed in Step K at the top of the heatsink.
- N. Reinstall the diskette drive by reversing the procedures described in Section 11.6.3 of the manual.
- O. Replace the cover by reversing the procedures described in Step B above.
- P. Connect AC to wall.
- Q. Perform Check-Out Procedure described in Section 6 below.
- R. Document installation of the FCO by completing a Call Report or Activity Report

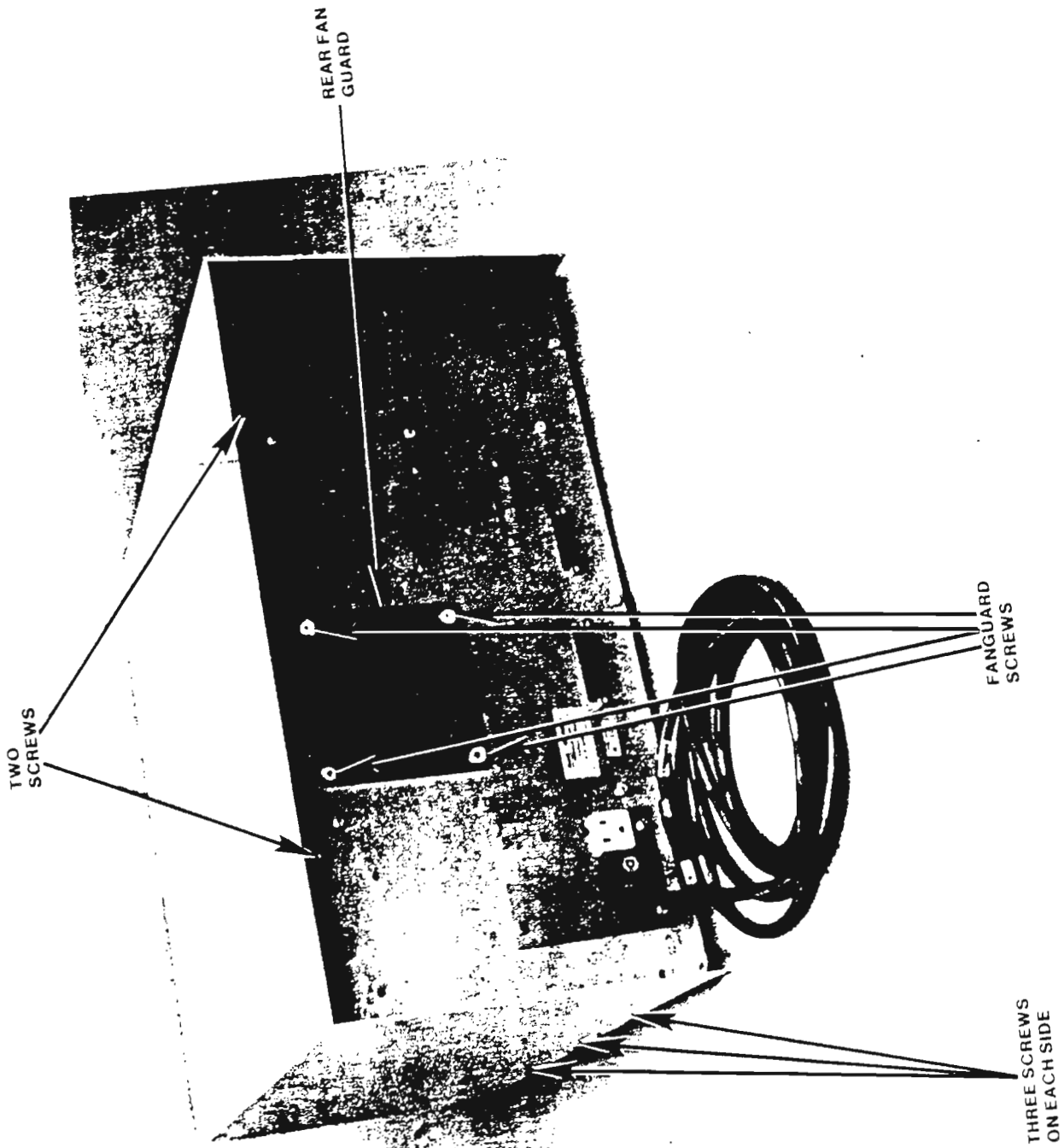

FIGURE 1 SVP CHASSIS/REAR VIEW

AC POWER
PLUG

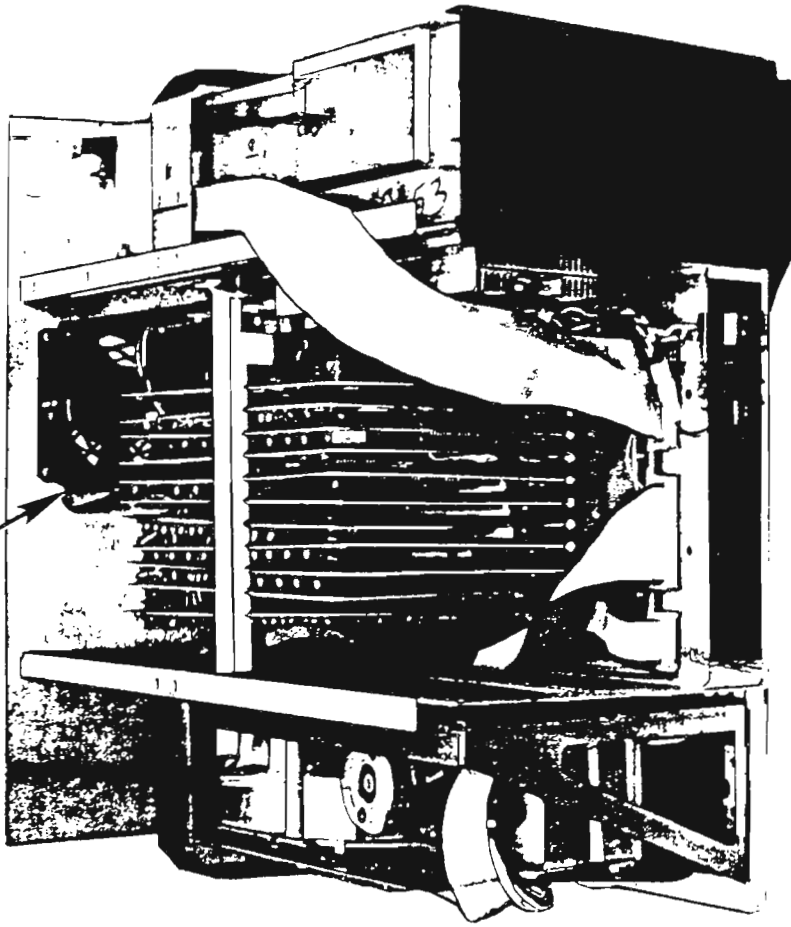

FIGURE 2 SVP CHASSIS / FRONT VIEW

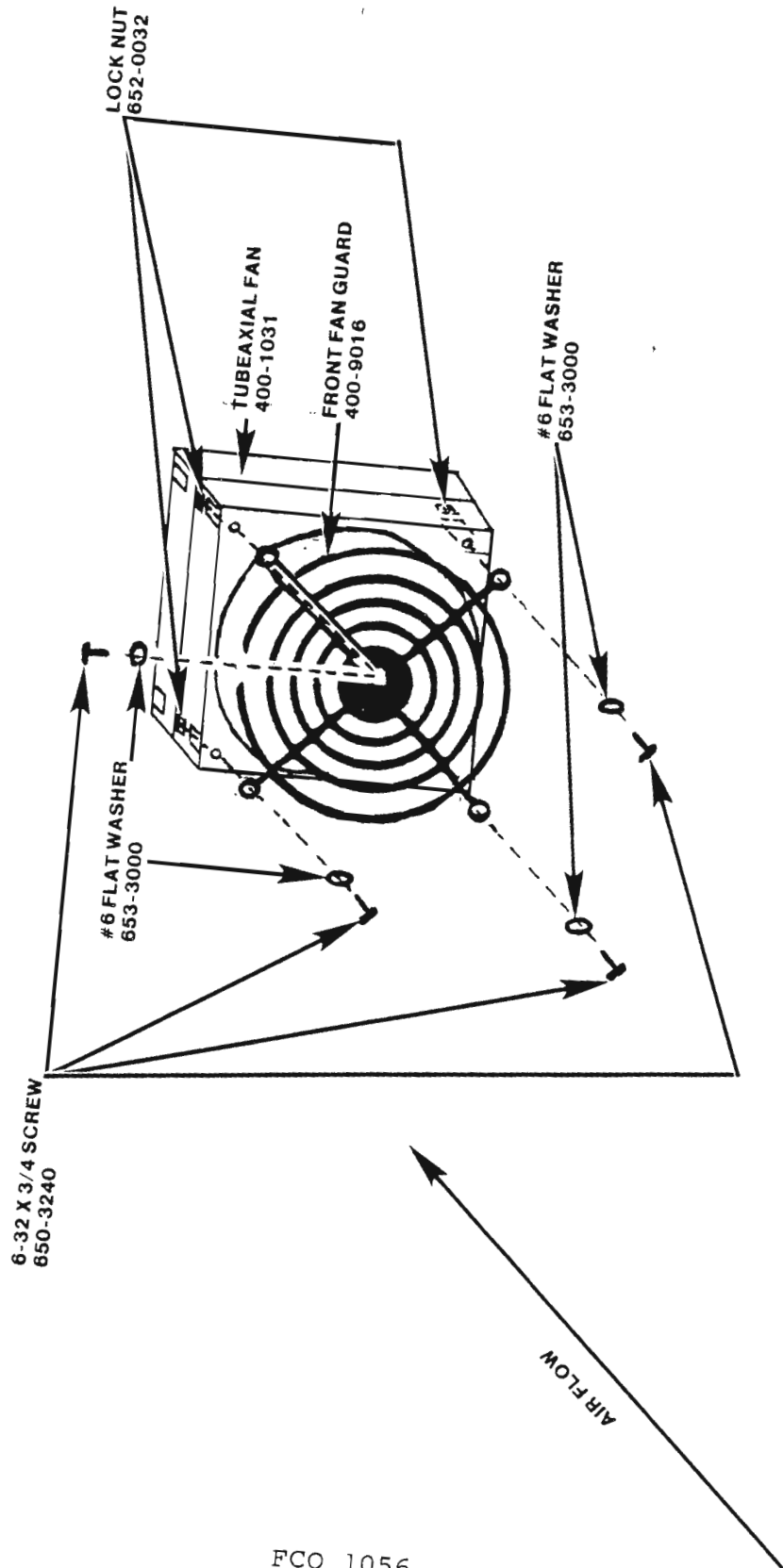

FIGURE 3 TUBEAXIAL FAN AND FRONT FAN GUARD ASSEMBLY/FRONT VIEW

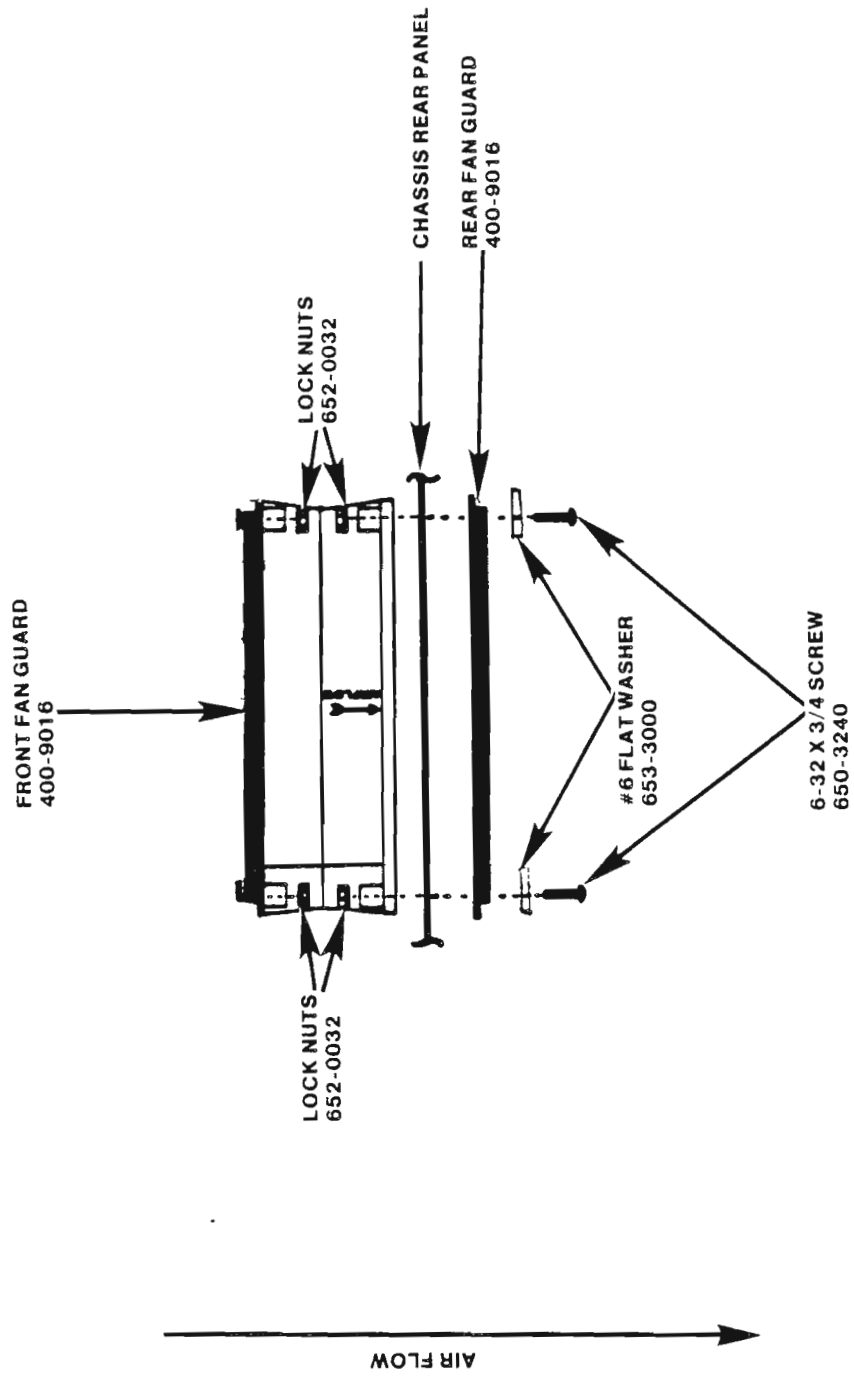
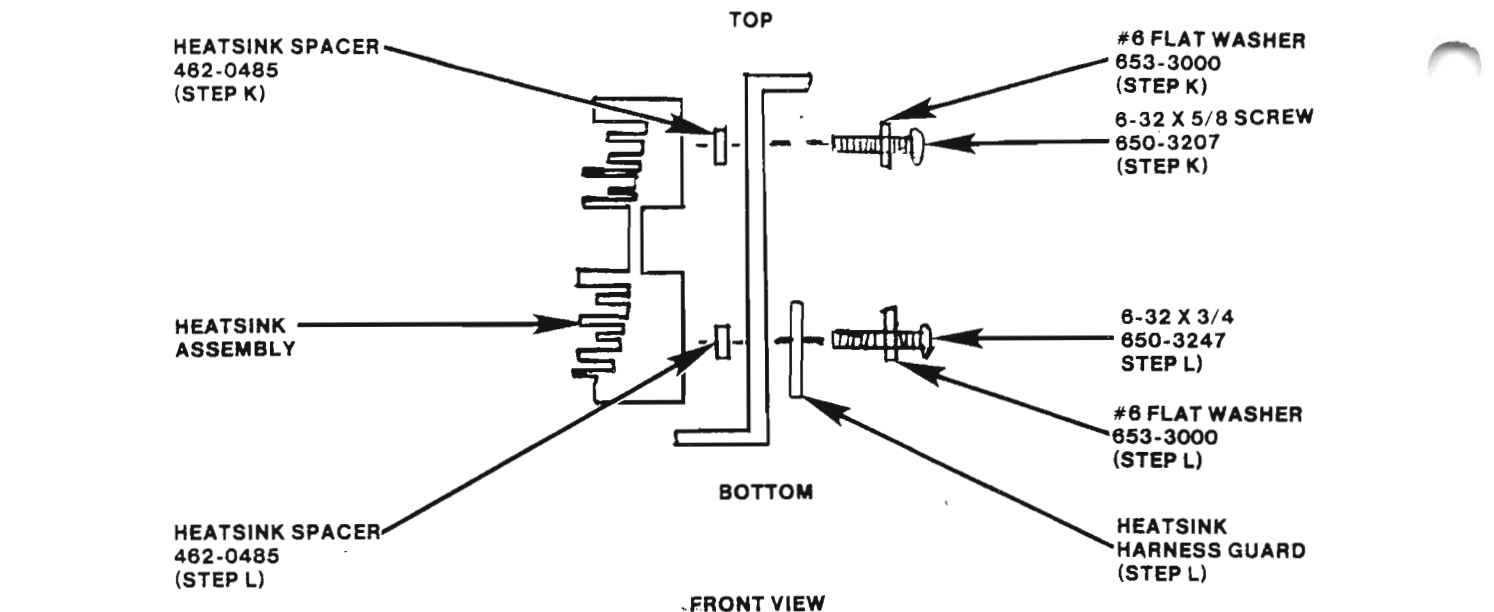
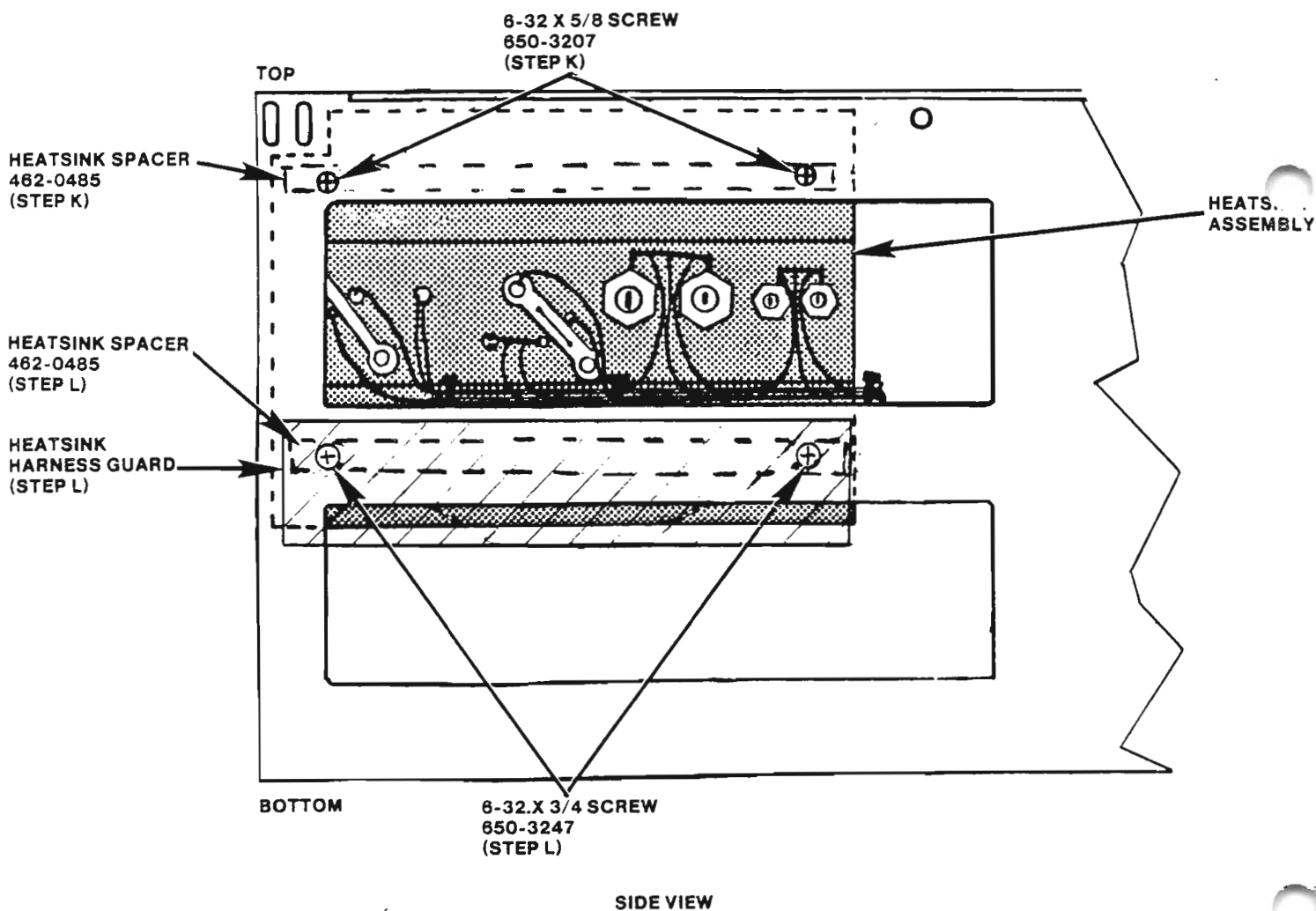

FIGURE 4 TUBEAXIAL FAN INSTALLATION/TOP VIEW



FRONT VIEW



SIDE VIEW

FIGURE 5 HEATSINK SPACER INSTALLATION

6. CHECK-OUT PROCEDURE

- A. Power up the unit. Observe normal operation of the fan. Air flow blows from the inside to the outside of the unit.
- B. Run 732-0002B LVP/SVP System Exerciser. Verify normal operation of the system.

7. FCO KIT PARTS LISTING

KIT #728-0074

<u>Item</u>	<u>Qty</u>	<u>Item Description</u>
729-1355	1	FCO Document 1056
400-1031	1	Fan, Tubeaxial 90CFM
400-9016	2	Fan Guard
650-3207	2	6-32x5/8 Ph Hd Sems
650-3247	2	6-32x3/4 Ph Hd Sems
462-0485	2	1/4" Spacer, Heatsink
650-3240	4	6-32x3/4 Ph Hd Sems
653-3000	12	Washer, #6 Flat

8. FCO KIT AVAILABILITY DATE

FCO Kit# 728-0074 will be available November 21, 1983. To obtain it, place a routine order through the Logistics Order Processing System.

9. REMOVED PARTS DISPOSITION

Discard the removed fan and its associated hardware.

10. MISCELLANEOUS

N/A

PRODUCT SERVICE NOTICE

DATE : 7/23/81

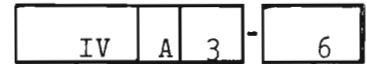

CLASSIFICATION 2200 SYSTEMS

CATEGORY MAINFRAMES

PRODUCT/APPL. VP/MVP/LVP/SVP CPU'S

SEQUENCE # 6

TITLE:

2228D EQUIPMENT MODIFICATION

This PSN provides information for modifying the SVP system to accept installation of the 2228D TC Controller (IV.B.2-M). This information is divided into two sections, paragraph 1.1 contains a PC Guide Block installation procedure and paragraph 2.2 contains a TC Back Panel installation procedure.



LABORATORIES, INC

ONE INDUSTRIAL AVENUE, LOWELL, MASSACHUSETTS 01851, TEL. (617) 459-5000, TWX 710 343-6769, TELEX 94-7421

PRINTED IN U.S.A.
REORDER NO.
729-0999

1.1 PC GUIDE BLOCK INSTALLATION

Presently, it is possible to install a 2228D backwards into the SVP Master Unit. To correct this problem a special PC Guide Block (WLI #449-0509) has been designed. When the guide block is used, it is impossible to install the 2228D board backwards. All SVP Master Units manufactured henceforth will have this guide block installed in the factory. To prevent this problem from occurring in systems presently in the field, it is the responsibility of the service representative to install the PC Guide Block in conjunction with a 2228D installation. The PC Guide Block is installed as follows:

Required Parts:

PC Guide Block	449-0509
1/2", #6 Self-Tapping Screw	651-0019

A. TOP COVER REMOVAL/REPLACEMENT

1. Using a phillips screwdriver, remove the six screws securing the sides of the cover (three on each side of unit) and the two screws securing the cover to the rear of the chassis (refer to Figure 1).
2. Slide the cover toward the front of the unit, and then lift the cover off.
3. To replace, reverse steps 1 and 2 of this procedure.

B. REMOVE CIRCUIT BOARD RETAINER

1. Squeeze the two clips that fasten the retainer to the regulator board (refer to Figure 2), and lift the retainer out of the slot in the regulator board.
2. Slide the left side of the retainer down and out of the slot into the chassis frame while lifting up on the right side of the retainer.

C. INSTALL PC GUIDE BLOCK

1. Align the PC Guide Block screw hole with the rear screw hole on the J3 connector, the J3 conn. is located in the I/O slot of the motherboard. Note the positioning of the PC Guide Block in Figure 3.
2. Insert the self-tapping screw through the screw hole in the guide block and into the J3 connector screw hole. Secure the block to the motherboard by screwing the screw into the Motherboard.
3. Install 2228D Controller board (refer to paragraph 4.2 of the 2228D TC Controller PMM (IV.B.2-M), reorder no. 729-0858).

2.1 TC BACK PANEL INSTALLATION

A TC Back Panel is required whenever a 2228D TC Controller is installed into a 2200SVP mainframe, because the two interface connectors (RS-232 and RS-449) located on the 2228D's mounting bracket are not accessible from outside the unit. Therefore, to gain access to these two connectors for modem connection, a TC Back Panel must be installed.

There are two TC Back Panels, one for each TC option. The RS-449 option uses a TC Back Panel with a 37-pin interface connector (WLI #220-3140), and the RS-232 option (#220-3109) uses a TC Back Panel with a 25-pin interface connector. The interface connector (RS-449 or RS-232) is mounted on the TC Back Panel and connects to the corresponding interface connector located on the 2228D mounting bracket, via a 20-inch ribbon cable.

The following is a step by step procedure for installing the TC Back Panel.

A. REMOVE TOP COVER

Remove top cover (refer to paragraph 1.1, step A of this PSN).

B. REMOVE TC PLATE:

Remove the TC Plate by unscrewing and saving the four machine screws that secure it to the rear of the 2200SVP Master Unit. Once all four screws are removed pull the plate away from the unit.

C. INSTALL TC BACK PANEL:

NOTE

Before installing the TC Back Panel route the 20 in. ribbon cable (connected to rear of panel) through the opening created by the removal of the TC Plate.

1. Use the four machine screws removed from the TC Plate to secure the TC Back Panel to the rear of the Master Unit.
2. The interface connector on the TC Back Panel is then connected to the corresponding interface connector on the 2228D TC Controller via a 20-inch ribbon cable.

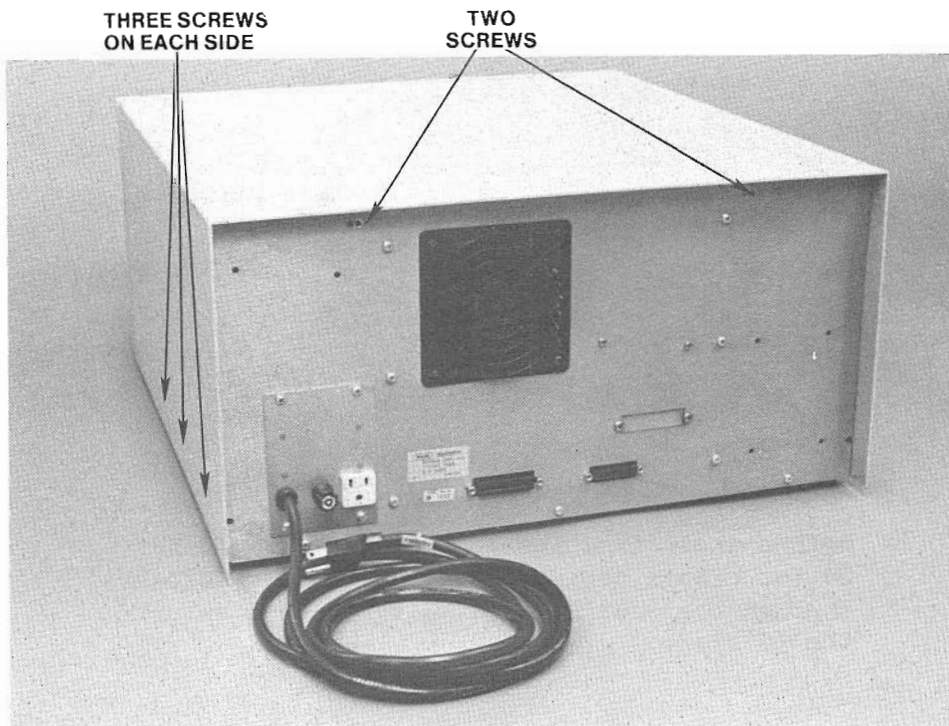

FIGURE 1 COVER REMOVAL

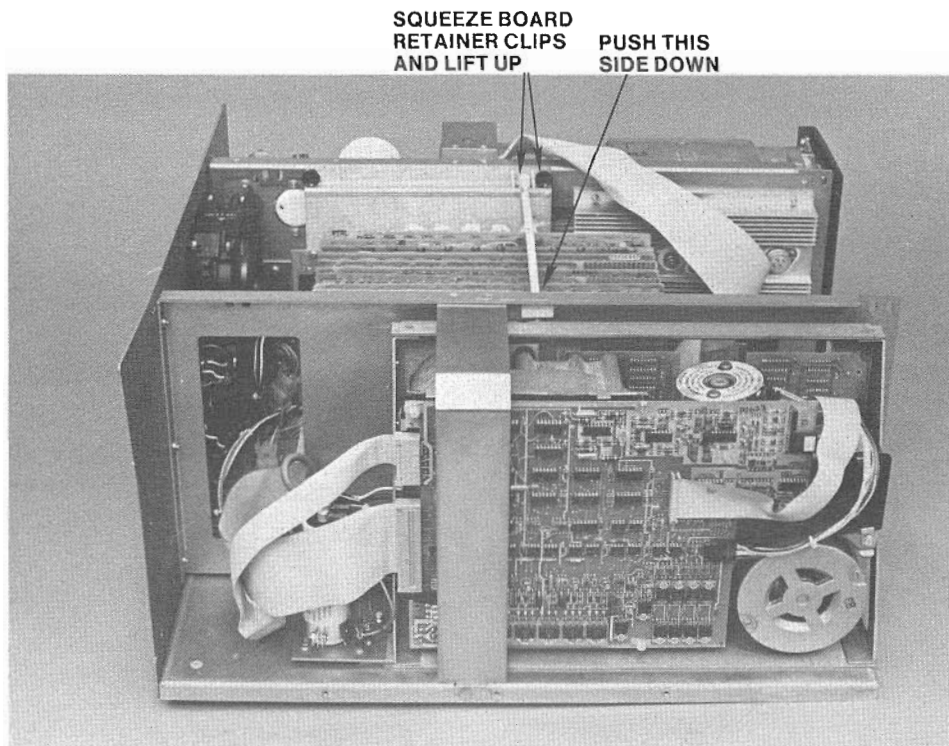

FIGURE 2 CIRCUIT BOARD RETAINER REMOVAL

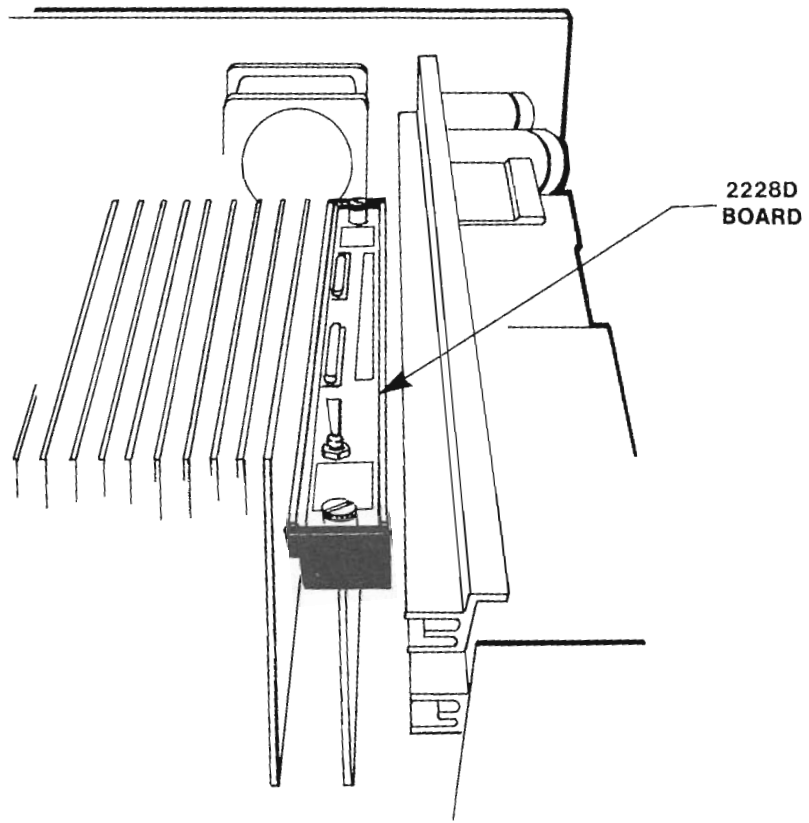
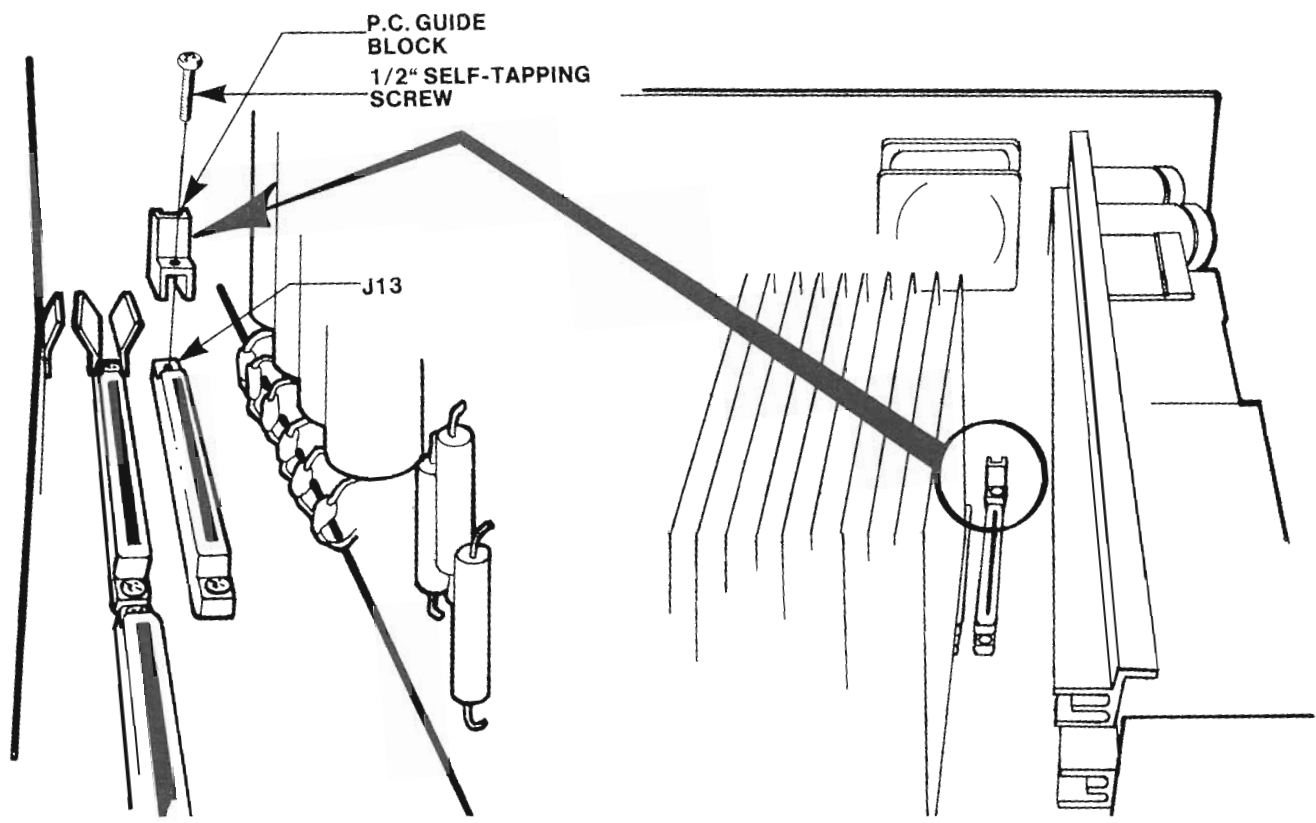

FIGURE 3 P.C. GUIDE BLOCK INSTALLATION

ORIGINATOR: Mark Hewett
 WRITTEN BY: Arlene Elliott
 PART NO.: 210-7887
 DWG NO.: 7887
 MODEL NO.: PCA 2200 SVP
 CLASS: I

Dept: M/S
 167 M/S
 REGULATOR CARD
 PEP # HU

EXT. 014-390
 EXT. 012-188

DATE 05/26/88
 DATE 05/26/88

DESCRIPTION: REGULATOR CARD
 PEP # HU

CLASS: I
 III
 PRELIMINARY

DESCRIPTION OF CHANGE
 NOTE 1: Engineering has decided that the artwork will not be modified at this time, it is not cost justifiable.

Change assembly drawing, schematic, parts list and sample board per attached prints and as follows:
 Rework Instructions:
 Add teflon jumper wire from Q3 emitter to plate thru hole at (4 D 1).
 Remove nylon screw at Q3. Replace with insulated shoulder washer and #4 screw and nut.
 Change BOM 210-7887 as follows:

W.L.I.#	DESCRIPTION	UM	COMP TYPE	QTY	TYPE
Change: 650-3137	SCREW 6-32 1/4 PAN HD	EA	1	5	1
Add: 375-9036	INSULATED SHOULDER	EA	1	1	1
650-2120	4-40 X 3/8 SCREW	EA	1	1	1
652-2005	4-40 LOCK NUT	EA	1	1	1
600-9012	24 GA YELLOW SOLID WIRE	FT	1	A/R	1

REASON/SYMPATOM FOR CHANGE
 JUN 22 1988
 Teflon jumper wire to prevent etch at Q3 emitter from burning.
 Nylon hardware at Q3 melts causing +5 volt failure.

COMPANY CONFIDENTIAL

DOCUMENTS

DOCUMENTS	FROM	TO	REVISIONS
HISTORY SHT. 510			
HISTORY SHT. 210	0	1	
ARTWORK			
E-REV.	7	8	
ASSY. DWG.			
DRILL DWG.			
SCHEM DWG.			
MECH. DWG.			
CBL DWG.			
S.P.I.			
SPECIFICATION			

CONFORMING AREA	CF	REMG.	DIST.	FINAL ASSY AREA	SUB ASSY AREA	NEXT ORDER	INFO ONLY
	X	X		X	X		

CONFORMANCE DATE

APPROVALS

APPROVALS	DATE
ECO CHAIRPERSON	
DES. ENGRG. <i>Michael Buntis</i>	6/6/88
CUST. ENGRG.	
MFG.	
MTO	
PP&M	
F.C.C. <i>Michael Buntis</i>	6/6/88
PROD. SAFETY <i>AD</i>	6/7/88
SECURE SYS.	
ORIGINATOR <i>Sunny Lin</i>	04/15/88
OTHER	

EF. DES. * HANG PART NO. * VALUE/TYPE * DESCRIPTION * DRAWING NO. * QTY.

RD NUMBER	DESCRIPTION	VALUE/TYPE	QTY
011	650-3080- SCRSR20604	6-32 X 1/4 PAN HD PHL MS SS SEMS	4
012	Change 650-3137- SCR30606	SCR 6-32 3/8 PAN HEAD SLOT NYLON	1
013	651-0205- GROMMET	GROMMET, NYLATCH H559-3-1	1
014 - 017	651-0213- PLNGR743	PLUNGER, NYLATCH H 323-3-1-1	1

375-9000 ILLUMIN SH ... QTY 1
650-2100 4 1/4 x 1/4 NYLON PH ... QTY 1
600-9012 24 Sta yellow anti explosion wire A/R

ECO NO 49287
 SHEET 2 OF 1

ADD 24 GA JUMPER
FROM Q3 EMITTER TO
PLATE THRU HOLE AT 'D1 4

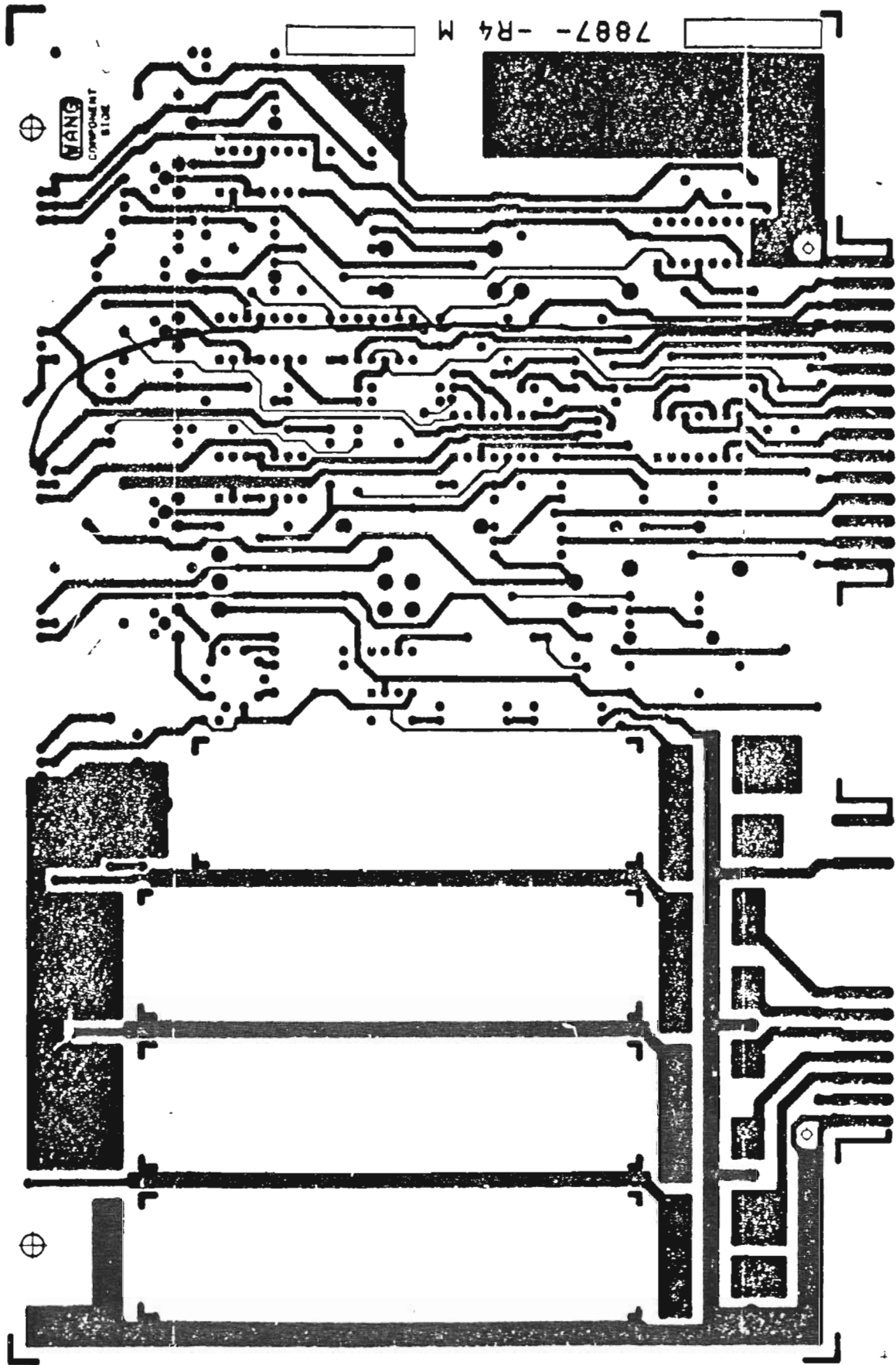

ECO NO 49287

SHEET 3 OF

X

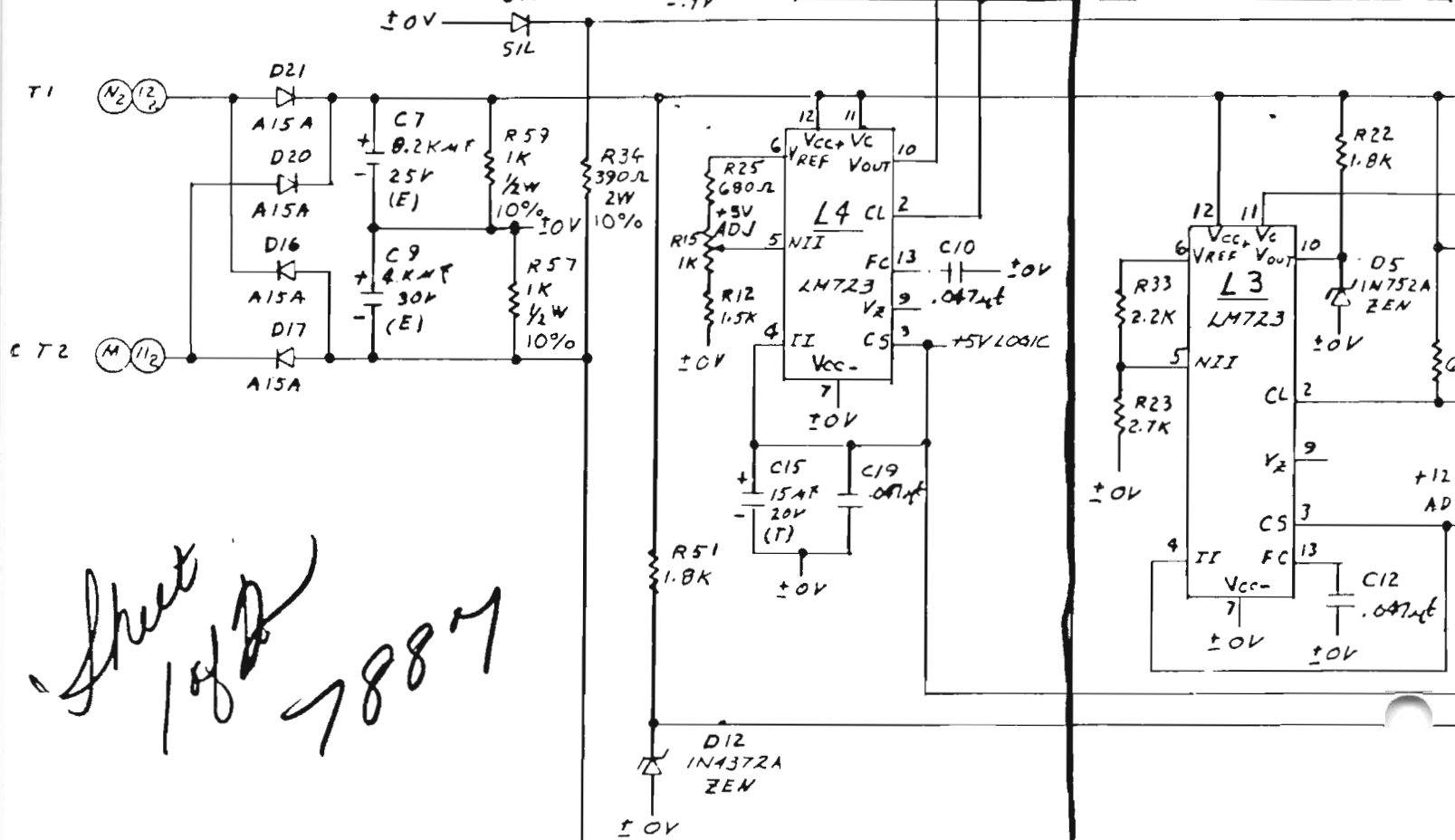
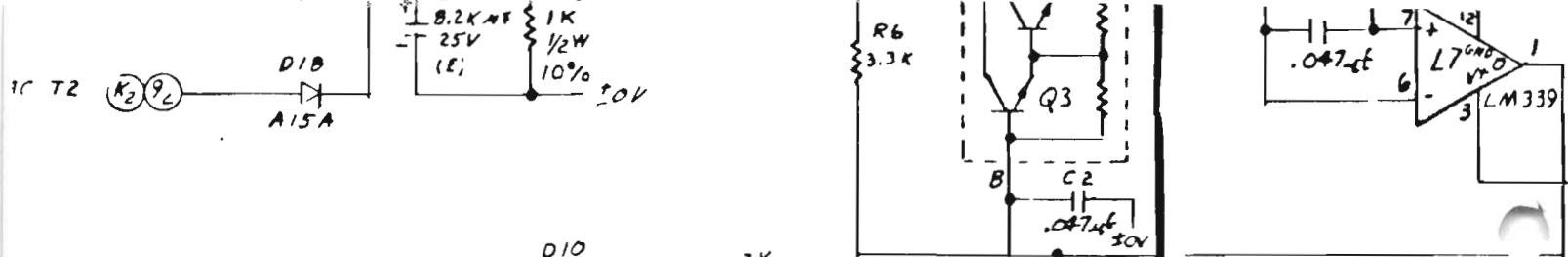

Sheet 1 of 2 7887

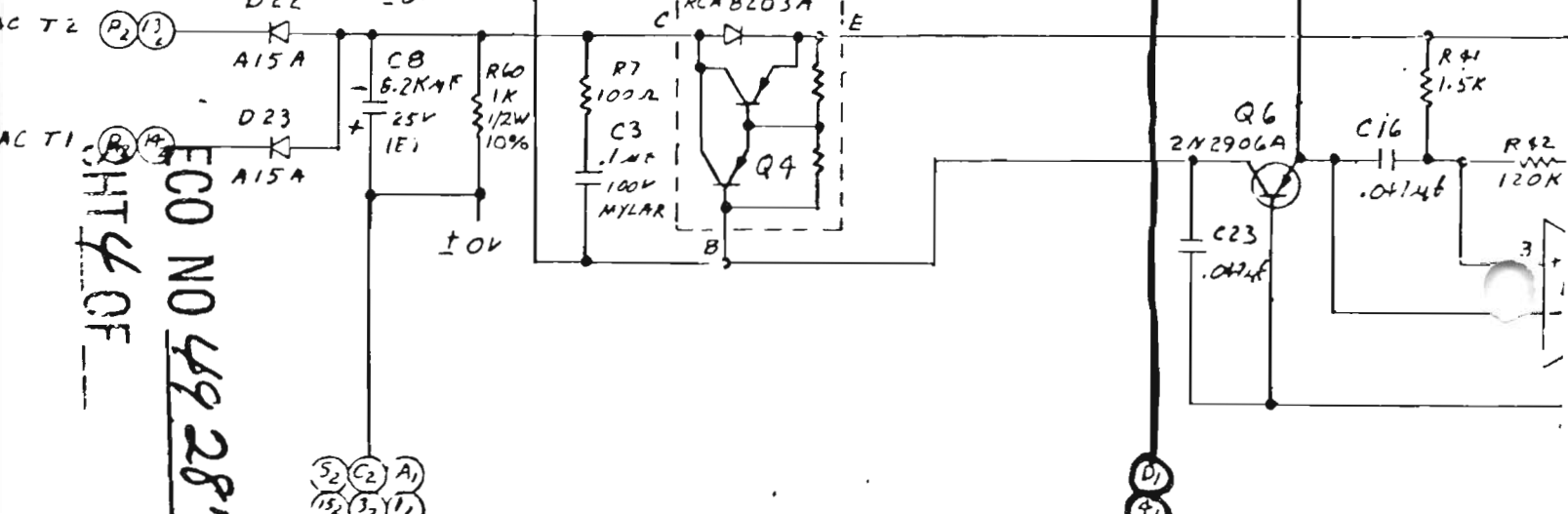
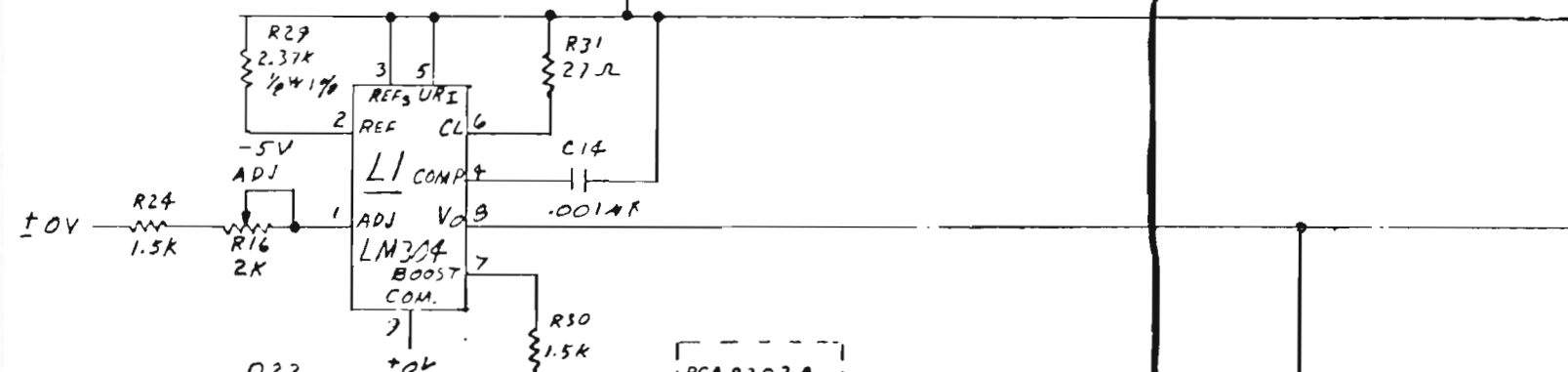

ECO NO 4928
PRINTED

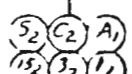

SVP

New Proms for 210-7890A Board

The 210-7890A is the single board controller used in SVP's with only DSDD floppy drives, whether it be one drive or two. There are several problems with the board which include:

1. Record handling problems with IBM routine.
2. Intermittent I94 and I98 errors.
3. Intermittent errors in 26th sector after formatting.

To correct these problems new proms have been released and may be ordered under a kit number 728-0012. The new proms are 378-6002-R2 and 378-4260-R2 to be installed in location L15 and L14 respectively. The 210-7890A board should be at E-REV 4 before installation and installed on a next call basis.

Enhancements provided with these proms include an increase in speed while verifying and while sequentially reading and writing with disk.

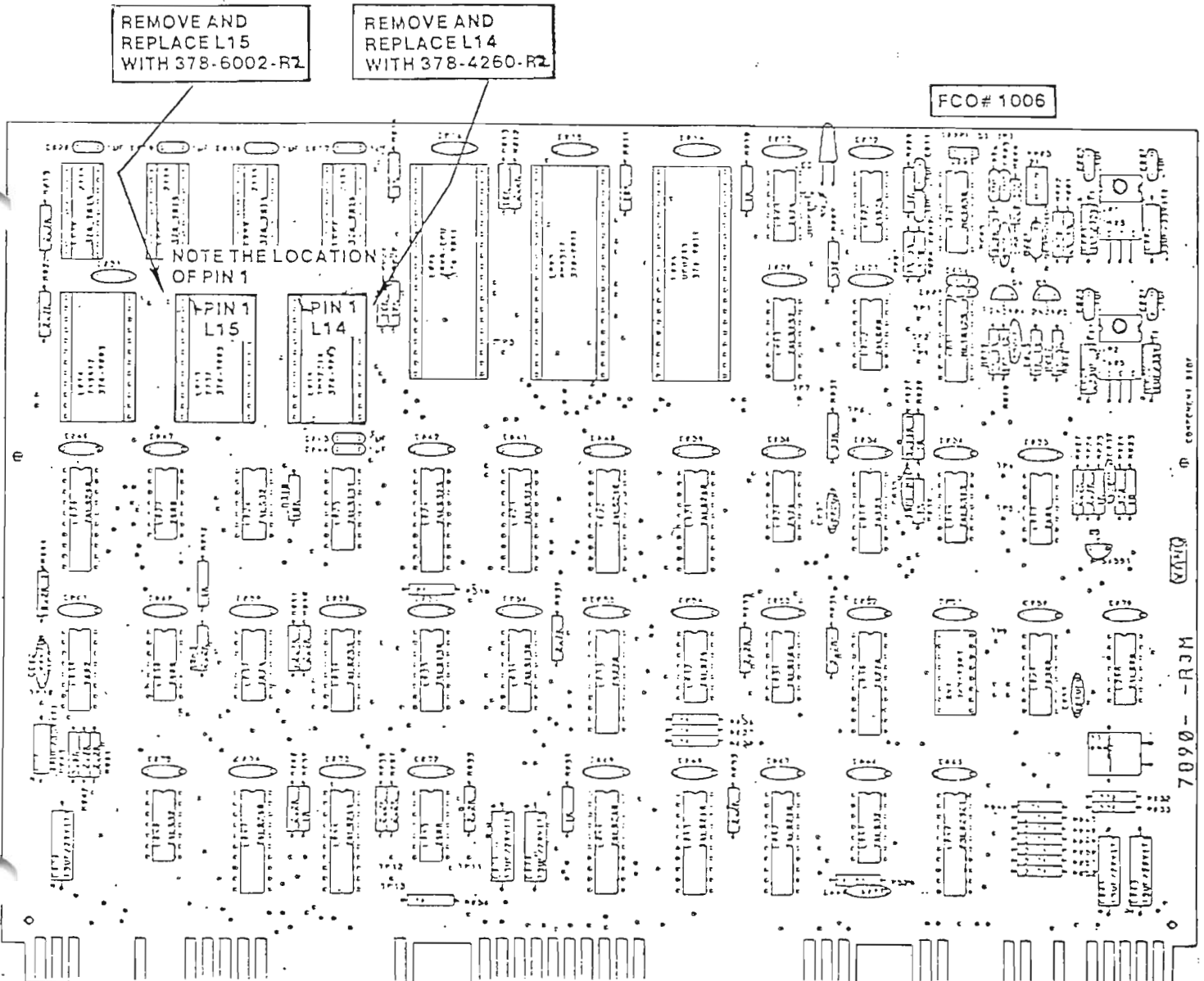

SVP

OPTION W

Option W allows the use of 3 terminals on an SVP. To utilize Option W the operating system must be MVP 2.4 or higher, a 32K control memory board is needed, and the prompts on the 6789 should be R3 to R5. The option board replaces the SVP terminal/printer controller board, part number 210-7789. The installation involves attaching 2 more RS232 connectors on the rear plate connecting to the Option W board (P/N 210-7846) via cabling. If the SVP does not have holes on the rear plate for the 2 extra RS232 connectors a new mounting rear plate will be needed.

Option W Board - 210-7846
3 Hole Rear Mounting Plate - 270-0683

There are 3 switch banks on the Option W board, each containing 4 switches.

Switch Bank 1 (baud rate for port 2) and Switch Bank 2 (baud rate for port 3) are set as follows:

Baud Rate	SW1	SW2	SW3	SW4
110				
134.5	X			
150		X		
200	X	X		
300			X	
600	X		X	
1200		X	X	
2400				X
4800		X		X
9600			X	X
19.2K	X		X	X

Port 0 is automatically set at 19.2 K.
Switch 3 is for device address and should have all switches off.

MVP/LVP & VP/SVP OPERATING SYSTEM RELEASE 2.2/2.4

The following is the memo and marketing release on the new MVP/LVP operating system release 2.2, and the new VP/SVP operating system release 2.4.

One of the new features is the CPU identification number. This number is contained in the PROMs located on the 210-6789 PCB. The PROM numbers and location are as follows:

L27	378-2045-R3
L28	378-2046-R3
L29	378-2047-R3

These PROMs were updated to R3 in MUB release #19, dated April 30, 1981.

If your customer is using a vendor's software package that is software protected, and the 210-6789 PCB becomes defective and must be replaced, these PROMs must be removed from the defective PCB and installed on the new PCB. Failure to do so will result in the inability to run the vendor's software protected programs.

A new numeric function, #ID, returns the CPU identification number. Each 2200 CPU is assigned a number (a random integer between 1 and 65535) at the time of manufacture. Machines produced prior to the implementation of this feature return a value of 0, but such machines can be field upgraded to have non-zero #ID's. CPU ID's are not guaranteed to be unique, but it is highly unlikely two given machines will have the same number.

This function allows software to tell one CPU from another. The ability to distinguish one CPU from another is useful in restricting software to specific installations and in telling one CPU from another when disk multiplexers are used.

SVPNew Multiple Terminal SVP

A new board has been designed for SVP which will support 1 to 3 terminals and a printer. This new board will be used in the place of the single terminal/printer controller board, 210-7789. The SVP will be modified to accept 2 more RS232 connectors on the rear plate with connecting ribbon cables. The new 3 terminal controller board is part number 210-7846.

6.6.2 New Products Needs/Requirements

6.6.2.1 The Customer Engineering Test Equipment Engineering Group will require a 210-7846 PCB for Millennium program Development by April 30, 1982. Complete 8/82.

6.6.2.2 Capital Equipment required for Repair (1) and Final System Test (2).

1) Minimum Capital Equipment Recommended for Repair of "Option W"

<u>ITEM</u>	<u>DESCRIPTION</u>	<u>CEI_PART_#</u>
420-1040	Loopback Connector	-
*210-7846-A	2200 SVP "Option W" Multi Port Board	-
*220-3237	"Option W" I/O Cable	-
*452-2292	Terminal Plate 232/366	-
**SVP	2200 SVP-8X 32K-1 MB Floppy Disk	177-3228
**2336DW	2336 Low Cost DW Workstation	177-3642 Dom 157-3642 Int'l
Millennium	Millennium Micro System Analyzer	727-0300
Millennium Z80 Pod	Millennium Z80 Emulator Pod	727-0302
Test Fixture	Millennium Test Fixture for	210-T249-7 210-7846-A/210-7789-A

2) Minimum Recommended Equipment for Final System Test of "Option W"

<u>ITEM</u>	<u>DESCRIPTION</u>	<u>CEI_PART_#</u>
420-1040	Loopback Connector	-
*210-7846-A	2200 SVP "Optional W" Multiport Board	-
*220-3237	"Optional W" I/O Cable	-
*452-2292	Terminal Plate 232/366	-
**SVP	2200 SVP 8X 32K-1MB Floppy Disk	177-3238
**2336DW	2336 Low Cost DW Workstation	177-3642 Dom 157-3642 Int'l

CUSTOMER ENGINEERING
TECHNICAL ASSISTANCE CENTER
NEWSLETTER

#30322

IV.B.1 (4202)

2200 SYSTEMS-INTERFACE-I/O CONTROLLERS.

TOPIC: GENERAL INFORMATION - 2236MXE AND SVP OPTION 'W'

DOCUMENTATION:

2236MXE TERMINAL CONTROLLER
PRODUCT MAINTENANCE MANUAL (July 1982) 729-1147

2200 SVP OPTION 'W'
PRODUCT SERVICE NOTICE (IV.A.3-8) 729-0935-1

The MXE manual can be ordered from stock. The SVP Option 'W' PSN will be shipped to the field on April 1, 1983. Please note that the PSN sequence number, -8, is the same as for the 2200 LVP Option 'C'. Due to the duplication in PSN numbers, please reference the reorder number to insure you have the correct document.

SOFTWARE REQUIREMENTS:

To operate either the MXE or the Option 'W', the Multi-User operating system software revision must be 2.4 or higher.

The bootstrap PROMs on the 210-6789 PCA should be at revision 3 or higher. It is suggested that the current revision of R-5 be used.

HARDWARE REQUIREMENTS:

The part number for the complete 2236MXE is 212-3032. The motherboard part number is 210-7874-A. The daughter board part number is 210-7973-A. When ordering a replacement, you must order the complete MXE by using the 212-3032 part number.

The part number for the 2200 SVP Option 'W' board is 210-7846. This is used to replace the original 2200 SVP terminal/printer controller board, 210-7729. If the 2200 SVP system's rear panel does not contain a mounting plate hole, a replacement rear plate, P/N 270-0583, must be ordered. The Option 'W' also requires that the system have a 210-7588-1 32K Control Memory board.

SWITCH SETTINGS - 2236MXE

Switch # 1 Device Address Switch

<u># of MXE</u>	<u>Sw #1</u>	<u>Sw #2</u>	<u>Sw #3</u>	<u>Sw #4</u>
1	OFF	OFF	OFF	OFF
2	ON	OFF	OFF	OFF
3	OFF	ON	OFF	OFF

Switch # 2 & 3 Baud Rate

Switch 2, positions 1, 2, 3, & 4 controls port #3
Switch 2, positions 5, 6, 7, & 8 controls port #4
Switch 3, positions 1, 2, 3, & 4 controls port #1
Switch 3, positions 5, 6, 7, & 8 controls port #2

<u>Baud Rate</u>	<u>Sw #1/5</u>	<u>Sw #2/6</u>	<u>Sw #3/7</u>	<u>Sw #4/8</u>
110	OFF	OFF	OFF	OFF
134.5	ON	OFF	OFF	OFF
150	OFF	ON	OFF	OFF
200	ON	ON	OFF	OFF
300	OFF	OFF	ON	OFF
600	ON	OFF	ON	OFF
1200	OFF	ON	ON	OFF
2400	OFF	OFF	OFF	ON
4800	OFF	ON	OFF	ON
9600	OFF	OFF	ON	ON
19,200	ON	OFF	ON	ON

SWITCH SETTINGS - 2200 SVP Option 'W'

Switch # 3 Device Address Switch

All positions on Sw # 3 should be set OFF

Switch # 1 & 2 Baud Rate

Switch 1 controls port #2
Switch 2 controls port #3

<u>Baud Rate</u>	<u>Sw #1</u>	<u>Sw #2</u>	<u>Sw #3</u>	<u>Sw #4</u>
110	OFF	OFF	OFF	OFF
134.5	ON	OFF	OFF	OFF
150	OFF	ON	OFF	OFF
200	ON	ON	OFF	OFF
300	OFF	OFF	ON	OFF
600	ON	OFF	ON	OFF
1200	OFF	ON	ON	OFF
2400	OFF	OFF	OFF	ON
4800	OFF	ON	OFF	ON
9600	OFF	OFF	ON	ON
19,200	ON	OFF	ON	ON

CUSTOMER ENGINEERING
TECHNICAL ASSISTANCE CENTER
NEWSLETTER

#40807

4103

2200 SYSTEMS-MAINFRAMES-VP/MVP/LVP/SVP

TOPIC: 2200 SYSTEM - MAINFRAMES VP/MVP/LVP/SVP

Within the last several months, there have been numerous inquiries regarding problems with Wang supplied diskettes and the SVP's single board Disk Processing Unit (DPU) #210-7890.

A format problem was found in Wang's duplicator for the 8" DSDD diskette.

The symptom found is that the diskette would not VERIFY on the 7890 controller but, works on the three board DPU.

The diskette duplicator has been fixed and all disks in stock should work on both the single and the three board DPU's.

If you have any customer's with problems with the Wang supplied diskettes, there are two (2) ways to solve the problem.

(°) Reorder the diskettes.

(2) Copy the customer's diskette, reformat the customer's diskette, then recopy the data back from the copied diskette to the original.

The #210-7890 PCB has another problem. Using the Phase LockLoop Adjustment Program (732-0009-A/B), the FORMAT PLATTER (SFO) will error out with an I93 on the floppy if the diskette has never been formatted using a three board DPU.

R&D is planning, in the future, to change the #210-7890 PROM to incorporate the formatting of the inner two tracks of the diskette.

CUSTOMER ENGINEERING
TECHNICAL ASSISTANCE CENTER
NEWSLETTER

#31122

4103

2200 SYSTEMS-MAINFRAMES-VP/MVP/LVP/SVP

TOPIC: FCO 1056 - SVP

FCO 1056 released in Mid-November 1983, to document ECO 28501, requires addition of two heatsink spacers and a fan replacement. This change reduces the audible noise level of the SVP and increases cooling of the diskette drive. To obtain the FCO Kit, place a routine order through the Logistics Order Processing System for WLI 728-0074.

CUSTOMER ENGINEERING
TECHNICAL ASSISTANCE CENTER
NEWSLETTER

#10127

III.A.10

PERIPHERALS-DISK DRIVES-2200 DISK PROCESSORS.

TOPIC: LVP DPU SECTION UPGRADES

TECHNICAL INFORMATION

THE E-REV LEVELS OF THE UPDATED BOARDS HAVE BEEN SET BACK TO "1" VIA ECO'S AS OF 11/18/80.

THE UPDATED BOARDS CAN BE RECOGNIZED BY THE FOLLOWING DISTINGUISHING FEATURES (PLUS A "1" ON THE BACKSIDE. CIRCUIT SIDE OF THE BOARD).

ECO

16884	210-7694:	L5 CONTAINS AN IC SOCKET L8 IS A 74S74 L9 IS A 74LS04 POTENTIOMETERS ARE GLYPTALLED
16885	210-7695:	L37 CONTAINS A 74S32
16886	210-7696:	PROM'S ARE R5 L8 IS A 74LS04 L19 IS A 74LS04

WITH THESE LATEST ECN'S INCORPORATED:

- SWITCH 3 OF SWITCHBANK SW1 ON THE WL# 210-7696-A (-B) BOARD MUST BE SET OFF.
- THE TOTAL AVAILABLE SECTORS ON THE DSDD DISKETTE DRIVE IS 3874 (SECTOR 0-3873) PLUS ONE TRACK (THE FIRST TRACK ON SIDE 0) OF SINGLE-DENSITY. THE AVAILABLE SECTORS PROVIDE STORAGE FOR 998,400 BYTES OF DATA. THESE FIGURES REFLECT THE CHANGE IN TRACKS/SURFACE FROM 77 TO 75.
- FORMATTING TIME FOR THE WINCHESTER DISK DRIVE IS APPROXIMATELY 13 MINUTES.
- FORMATTING FOR THE DSDD DISKETTE DRIVE IS APPROXIMATELY 2 MINUTES.
- THE PLO ADJUSTMENT IS NO LONGER REQUIRED. THE POTENTIOMETERS WILL BE GLYPTALLED AFTER THE INITIAL ADJUSTMENT HAS BEEN PERFORMED IN MANUFACTURING.
- INITIALLY, WHEN FIRST POWERED-UP AND/OR RESET IS KEYED, IT IS NORMAL TO HAVE THE WINCHESTER DRIVE DO SEVERAL TRK 00 SEEKS. AFTER SEVERAL MINUTES OF OPERATION, RESETS SHOULD NOT CAUSE TRK 00 SEEKS.



LABORATORIES, INC.

CUSTOMER ENGINEERING
TECHNICAL ASSISTANCE CENTER
NEWSLETTER

#10317

IV.A.3

2200 SYSTEMS-MAINFRAMES-VP/MVP/LVP CPU'S.

TOPIC: 2200LVP/SVP "B" CONFIGURATION

A prom swap on the 210-7696A is necessary when used in an LVP or SVP "B" configuration. (i.e. 278-4013, 60 hz; or 278-4013-1, 50 hz.) The following chart explains the loadings for the 210-7696 and 210-8696.

<u>Location</u>	<u>"X, C & D" Configurations</u>	<u>"B" or "D" Configurations</u>
L29	378-4220-R05	378-4220-R05
L28	378-4221-R05	378-4221-R05
L27	378-4222-R05	378-4222-R05
L26	378-4223-R05	378-4230-R05

Prom 378-4230 must replace 378-4223 for all "B" configurations. This prom may also be used in the "D" configuration.

The FSC's have the program for the prom; Logistics recommends that any branches supporting a "B" configuration stock the 378-4230 at the latest rev. level. Logistics is only allocating stocking the 210-7696A and the 378-4230 - not the 210-7696B! Please do not order the 210-7696B.



LABORATORIES, INC.

CUSTOMER ENGINEERING
TECHNICAL ASSISTANCE CENTER
NEWSLETTER

#10317

IV.C.4
2200 SYSTEMS-OPERATING SYSTEMS.

TOPIC: SVP OPERATING SYSTEM RELEASE 2.3

```

* * * * *
*
*           NOTICE
*
*   SVP SOFTWARE DISKETTE PART NUMBER 704-0001A
*   MAY CONTAIN MVP SOFTWARE AND NOT SVP SOFTWARE
*
* * * * *

```

This is the correct diskette part number for the SVP Operating System Software, but the MVP Operating System software was copied onto the diskette by mistake. It is not known how many diskettes are incorrect. Please check all SVP diskettes at your location to insure that they contain the correct operating system. The part number, 704-0001A, is still valid for the SVP Operating System Software.

WANG

LABORATORIES, INC.

CUSTOMER ENGINEERING
TECHNICAL ASSISTANCE CENTER
NEWSLETTER

#10324

IV.A.3

2200 SYSTEMS-MAINFRAMES-VP/MVP/LVP CPU'S.

TOPIC: _CORRECTION_TO_2200_SVP_MAINTENANCE_MANUAL

Reference: 2200 SVP Computer Product Maintenance Manual;
IV.A.3 MA-0; WL# 729-0863.

Page 8-16:

Figure 8-11 WL No. 210-7890-A Dual DSDD Diskette Drive
Controller.

The part number for Prom L14 is 378-6002.
The part number for Prom L15 is 378-4260.

Switch number 8 in switchbank SW1 must be on for normal
operation.

CUSTOMER ENGINEERING
TECHNICAL ASSISTANCE CENTER
NEWSLETTER

#10929

III.A.14

PERIPHERALS-DISK DRIVES-SHUGART Q2000 WINCHESTER (8 INCH).

TOPIC: QUANTUM 8 INCH MEDIA FIXED DISK DRIVE

WANG LABORATORIES WILL SOON MAKE AVAILABLE, IN SEVERAL SYSTEM MODELS, THE QUANTUM 8 INCH MEDIA FIXED DISK DRIVE.

THE QUANTUM SERIES 2000 DISK DRIVE IS A RANDOM ACCESS STORAGE DEVICE WITH ONE, TWO, THREE, OR FOUR NON-REMOVABLE 8 INCH RIGID DISKS AS STORAGE MEDIA. EACH DISK SURFACE EMPLOYS ONE MOVABLE HEAD TO ACCESS THE 512 DATA TRACKS. THE FOUR MODELS OF THE Q2000 SERIES ARE Q2010, Q2020, Q2030, AND Q2040.

	<u>PLATTERS</u>	<u>MOVEABLE HEADS</u>	<u>STORAGE</u>
Q2010	1	10.66 MEGABYTE	2
Q2020	2	21.33 "	4
Q2030	3	32.00 "	6
Q2040	4	42.66 "	8

THE Q2000 SERIES DISK DRIVE IS SUPPLIED WITH AN ACTUATOR LOCK AND A SPINDLE LOCK FOR SHIPPING PROTECTION. THESE LOCKS MUST BE REMOVED BEFORE THE SYSTEM IS POWERED UP. FOLLOW THE STEPS BELOW FOR REMOVING THE LOCKS. PLEASE NOTE THAT IN SYSTEMS SHIPPED WITH THIS MODEL DRIVE, THE DRIVE MUST BE REMOVED FROM THE SYSTEM TO PERFORM THESE STEPS.

MOTOR LOCKING CLIP:

- A) STAND DRIVE ON EDGE TO UNLOCK DRIVE MOTOR.
- B) LOOSEN 11/32 INCH HEX NUT.
- C) ROTATE LOCKING CLIP AWAY FROM PULLEY. DO NOT ROTATE PULLEY.
- D) RETIGHTEN 11/32 INCH HEX NUT.

ACTUATOR LOCK:

UNLOCK ACTUATOR BY ROTATING THE ACTUATOR LOCK CCW AS FAR AS IT WILL GO (APPROX. 1/2 TURN). DO NOT FORCE. THE ACTUATOR LOCK IS LOCATED ON THE BOTTOM OF THE DRIVE.

CUSTOMER ENGINEERING
TECHNICAL ASSISTANCE CENTER
NEWSLETTER

#20316

IV.A.3

2200 SYSTEMS-MAINFRAMES-VP/MVP/LVP CPU'S.

TOPIC: NEW DPU PROMS FOR THE 210-8696 PCA

The 210-8696 Microcomputer/Memory (DPU) PCA has had its PROMs upgraded to Revision R-8. The PROM loading is as shown below.

* Do not use R6 or R7 PROMs.

Location	Old PROM Number	New PROM Number
L-29	378-4220-R*	378-4220-R8
L-28	378-4221-R*	378-4221-R8
L-27	378-4222-R*	378-4222-R8
L-26**	378-4223-R*	378-4223-R8
L-26**	378-4230-R*	378-4230-R8

* - This includes PROMs that are revision R-5, R-6, R-7, plus any revision older than R-5.

** - L-26 will be a 378-4223 on the 210-8696-A for either the 4 or 8 Meg Winchester.

L-26 will be a 378-4230 on the 210-8696-B for either the 2 or 8 Meg Winchester.

The PROM revision R-7, and above, requires a new PLL diagnostic diskette. The P/N of the new diskette is 732-0009A (reference the other entries in section IV.A.3 for TAC Newsletter #20316)

IV.A.3

2200 SYSTEMS-MAINFRAMES-VP/MVP/LVP CPU'S.

TOPIC: NEW "LEG LEVELERS" FOR THE 2200 LVP

The 2200-LVP's are being shipped with new, larger, casters which enable the LVP system to roll easily. With the new casters, the present screw down legs will not reach the floor when the customer tries to level the system in a permanent location. The new, longer levelers which should be used with the larger casters, may be ordered by WLI P/N 655-0284.

IV.A.3

2200 SYSTEMS-MAINFRAMES-VP/MVP/LVP CPU'S.

TOPIC: NEW PLL UTILITY DISKETTE - P/N 732-0009A

Please be aware that with the DPU PROMs being upgraded to R-8, the present PLL Utility Diskette, P/N 732-0009, will not operate when trying to do the PLL alignment on the Winchester. If your system has the R-7 or R-8 revision PROMs on the 210-8696 PCA, you must order the new PLL utility diskette. The WLI P/N for the new diskette is 732-0009A.

Please refer to the other entries in section IV.A.3 for TAC Newsletter #20316, for the PROM loading for the 210-8696 DPU PCA.

CUSTOMER ENGINEERING
TECHNICAL ASSISTANCE CENTER
NEWSLETTER

#20406

IV.C.4

2200 SYSTEMS SOFTWARE RELEASES

TOPIC: 2200 SOFTWARE/HARDWARE BULLETIN #1 (DECEMBER 1, 1981)

PREFACE

The purpose of this Software/Hardware Bulletin is to provide up-to-date documentation for hardware and software enhancements to the 2200 Series until the appropriate manuals are revised.

This bulletin describes the changes and features of Release 2.3 of the 2200 BASIC-2 Multiuser Operating System and discusses the 2200 MVPC, 2200 LVPC and 2200 SVP Central Processing Units (CPUs).

This documentation is intended to be used in conjunction with the following manuals.

BASIC-2 Utilities Reference Manual (700-6855)

Wang BASIC-2 Language Reference Manual (700-4080D)

Wang BASIC-2 Disk Reference Manual (700-4081G)

CUSTOMER ENGINEERING
TECHNICAL ASSISTANCE CENTER
NEWSLETTER

#20406

IV.C.4

2200 SYSTEMS SOFTWARE RELEASES

TOPIC: 2200 SOFTWARE/HARDWARE BULLETIN #1 (DECEMBER 1, 1981)

(Continued)

2200 SYSTEM ENHANCEMENTS

THE 2200MVPC CENTRAL PROCESSING UNIT

The 2200 MVPC Central Processing Unit (CPU) incorporates all the features of the 2200 MVP and supports an increased amount of user memory and control memory. User memory is available in 64K, 128K, 256K, 348K and 512K bytes. User memory can be upgraded in the field. The MVPC chassis contains seven I/O slots; each I/O slot can contain a controller capable of controlling one or more peripherals. The MVPC, like the MVP, supports Release 2.3 of the BASIC-2 Multiuser Operating System.

THE 2200LVPC CENTRAL PROCESSING UNIT

The 2200 LVPC Central Processing Unit (CPU) incorporates all the features of the 2200 LVP and additionally supports an increased amount of disk capacity, user memory and control memory. The Winchester-style disk drive for the LVPC is available in 2, 4, 8, 16, or 32-megabyte storage capacities. User memory is available in 64K, 128K, 256K, 348K and 512K bytes. Both user memory and disk capacity can be upgraded in the field. The LVPC chassis contains seven I/O slots; each I/O slot can contain a controller capable of controlling one or more peripherals. The LVPC, like the LVP, supports Release 2.3 of the BASIC-2 Multiuser Operating System.

THE 2200SVP CENTRAL PROCESSING UNIT

Several features have been added to the 2200 SVP Central Processing Unit (CPU), enabling it to function as a multiprogramming system, optionally supporting an expanded memory size and disk storage capacity. The following features are now available on the 2200 SVP.

User memory can be expanded up to 128K bytes.

User memory can be divided into up to 16 partitions, each supporting a separate program or task. The SVP can use the BASIC-2 Multiuser Operating System and the full complement of BASIC-2 Utilities such as @GENPART and @PSTAT.

CUSTOMER ENGINEERING
TECHNICAL ASSISTANCE CENTER
NEWSLETTER

#20406

IV.C.4

2200 SYSTEMS SOFTWARE RELEASES

TOPIC: 2200 SOFTWARE/HARDWARE BULLETIN #1 (DECEMBER 11, 1981)
(Continued)

Foreground/background processing is supported.

An optional Winchester fixed disk drive with an 8-megabyte capacity is available.

USER MEMORY

The 2200 SVP, with a standard user memory capacity of 32K bytes, can optionally support up to the 128K bytes of user memory. A standard 2200 SVP can be optionally configured with one or two banks of user memory, each bank consisting of 64K bytes of storage.

MULTIPROGRAMMING FEATURES

The 2200SVP now can simultaneously process up to 16 different tasks. After the operator presses the Special Function key that loads the system programs from the system platter, the operator employs the Partition Generator utility (@GENPART) to distribute system resources. Partition operations can be monitored by means of the Partition Status utility (@PSTAT). Both the Partition Generator utility and the Partition Status utility reside on the system platter.

The 2200 SVP can support up to 16 partitions of varying sizes. The number and size of the partitions are determined by the operator. Within each bank, a fixed amount of the memory is reserved for system overhead and cannot be accessed by the user. The first bank requires 3K bytes and the second bank, 8K bytes. These amounts of memory are fixed for 2200 SVP systems containing one or two banks, regardless of the total memory contained in each bank. The operator can divide the remainder of each bank into a number of partitions of fixed size; a total of 61K bytes in Bank 1 and 56K bytes in Bank 2 are available for user partitions. No partition can overlap banks. In addition, each partition in each bank requires approximately 1K bytes of partition overhead. All remaining memory in a single partition is available for user programs and data.

CUSTOMER ENGINEERING
TECHNICAL ASSISTANCE CENTER
NEWSLETTER

#20406

IV.C.4

2200 SYSTEMS SOFTWARE RELEASES

TOPIC: 2200 SOFTWARE/HARDWARE BULLETIN NO. 3 (DECEMBER 1971)
(Continued)

The 2200 SVP user can now execute a variety of special functions and statements that address multiprogramming needs, including global subroutines and variables and a temporary seize/release capability for programs using shared devices. These functions and statements are briefly explained in the following list; they are discussed in detail in Chapter 16 of the Wang BASIC-2 Language Reference Manual (700-40800).

The following BASIC-B functions can now be used on the 2200 SVP.

#PART Returns a numeric value equal to the partition number of the originating partition for this job.

!PSTAT Returns the current status of the specified partition. The status information includes a user-defined status message, operating system type (VPL or MVL), operating system release number, partition size, terminal number, global name, ERR function value and I/O device currently in use.

#TERM Returns a numeric value equal to the terminal number of the terminal assigned to the originating partition for this job.

CUSTOMER ENGINEERING
TECHNICAL ASSISTANCE CENTER
NEWSLETTER

#20406

IV.C.4

2200 SYSTEMS SOFTWARE RELEASES

TOPIC: 2200 SOFTWARE/HARDWARE BULLETIN #1 (DECEMBER 15, 1981)
(Continued)

The following BASIC-2 statements can now be used on the 2200 SVP.

- ;BREAK** - Relinquishes a specified amount of the current partition's execution time for use by other partitions.
- ;CLOSE** - Releases one or more housed devices.
- DEFFN @PART** - Defines the current partition as global.
- ;INIT** - Passes configuration parameters to the operating system.
- ;MSC** - Defines a broadcast message available to all terminals (can be executed only by Terminal 1).
- ;OPEN** - Hogs one or more devices.
- ;PSTAT** - Sets the user-defined portion of the partition status.
- ;RELEASE PART** - Causes ownership of a partition by a terminal to be relinquished.
- ;RELEASE TERMINAL** - Detaches the terminal from the current partition.
- SELECT @PART** - Selects a specified global partition for subsequent global subroutine and global variable references.

The SVP user can economize on the use of memory by defining one or more global partitions within each memory bank. The variables stored in a global partition are accessible to other partitions within that bank. Though a global partition in Bank 1 cannot be accessed by partitions in Bank 2, and vice versa, a 5K byte area of Bank 1 can be reserved as a universal global partition area. A universal global partition, located entirely within this 5K byte area, can be employed to store control variables used by any partition in either Bank 1 or 2.

CUSTOMER ENGINEERING #655032
TECHNICAL ASSISTANCE CENTER 177455TT
NEWSLETTER

#20406

IV.C.4

2200 SYSTEMS SOFTWARE RELEASES

TOPIC: 2200 SOFTWARE/HARDWARE BULLETIN #1 (DECEMBER 1963)
(Continued)

The 2200 SVP enables a programmer to make common routines and variables accessible to a number of different programs. For instance, if several programs must share a common disk file, all access to the disk file can be controlled by a single routine, contained in a global partition. Whenever a program attempts to access the file, the program branches to the global routine, and the routine actually performs the access. Additionally, global variables can be contained in the same global partition as the routine. Programs running in separate partitions can interrogate and modify global variables, using them as flags to indicate the status of the disk file and to transfer control information. In this way, a central routine controls the use of a resource shared by several programs, oversees the operations of these programs, and resolves potential conflicts among them.

The ;OPEN and ;CLOSE statements enable a program to seize temporary control of a device and subsequently release it. These features are important for operations requiring shared devices that do not lend themselves to interleaved use by several programs, and for special disk operations where one program must have exclusive access to the disk temporarily. For example, a program can temporarily seize a shared printer, complete all necessary printing, and then release the printer so that another partition can use it.

Foreground/Background Operation

Though the terminal can communicate with only one job at a time, it can run up to 16 jobs concurrently, depending upon the partitioning of memory. A terminal can be switched from one partition to another by means of the ;RELEASE TERMINAL statement. The ;RELEASE TERMINAL statement shifts the executing foreground job into the background and a specified background job into the foreground, to permit operator communication with that program.

CUSTOMER ENGINEERING
TECHNICAL ASSISTANCE CENTER
NEWSLETTER

#20406

IV.C.4

2200 SYSTEMS SOFTWARE RELEASES

TOPIC: 2200 SOFTWARE-HARDWARE BULLETIN #1 (DECEMBER 17, 1981)
(Continued)

Fixed Disk Drive

The 2200 SVP now supports an 8-megabyte fixed disk drive as a system option. The following list summarizes the disk storage options available for configuration with the 2200 SVP.

- One dual-sided, double-density (DSDD) 5.25-inch floppy diskette drive (standard)
- Two DSDD diskette drives (dual diskette system)
- One DSDD diskette drive and a fixed Winchester-style disk drive (optional 2, 4, or 8 megabytes)

CUSTOMER ENGINEERING
TECHNICAL ASSISTANCE CENTER
NEWSLETTER

#30524

4103

2200 SYSTEMS-MAINFRAMES-VP/MVP/LVP/SVP CPU'S.

TOPIC: SVP-2236LRS LOCAL/REMOTE SWITCH

It has been determined that the 2236LRS will not operate on an SVP with the option "W" installed. This configuration is not supported.

*** Any customer questions regarding the LRS should be referred to the local Marketing Representative.