

2200 DW/22-20 Daisy Printer User Manual

2nd Edition — November, 1982
Copyright © Wang Laboratories, Inc., 1982
700-7629

WANG

WANG LABORATORIES, INC., ONE INDUSTRIAL AVENUE, LOWELL, MA 01851 • TEL 617/459-5000, TWX 710-343-6769, TELEX 94-7421

Disclaimer of Warranties and Limitation of Liabilities

The staff of Wang Laboratories, Inc., has taken due care in preparing this manual; however, nothing contained herein modifies or alters in any way the standard terms and conditions of the Wang purchase agreement, lease agreement, or rental agreement by which this equipment was acquired, nor increases in any way Wang's liability to the customer. In no event shall Wang Laboratories, Inc., or its subsidiaries be liable for incidental or consequential damages in connection with or arising from the use of this manual or any programs contained herein.

Warning: This equipment generates, uses, and can radiate radio frequency energy and, if not installed and used in accordance with the instructions manual, may cause interference to radio communications. It has been tested and found to comply with the limits for a Class A computing device pursuant to Subpart J of Part 15 of FCC Rules, which are designed to provide reasonable protection against such interference when operated in a commercial environment. Operation of this equipment in a residential area is likely to cause interference in which case the user at his own expense will be required to take whatever measures may be required to correct the interference.



PREFACE

This manual describes the characteristics and operation of the DW/22-20 Daisy Printer, designed by Wang Laboratories, Inc., as an option for 2200 Computer Systems. It is assumed that you are familiar with these Wang systems. For additional information on the use of printers with these systems, refer to the 2200 Word Processing Operator's Guide (700-6937) or the Wang BASIC-2 Language Reference Manual (700-4080).

Chapter 1 of this manual contains general information on printer capabilities. Chapter 2 describes printer controls and indicators. Chapter 3 contains information on printer operation.

Chapter 4 describes methods of selecting the printer for output. Chapter 5 and 6 illustrate various techniques for formatting output. Chapter 5 demonstrates the use of BASIC-2 statements to format printed output; and Chapter 6 illustrates the use of Hex codes to control a wide variety of format and character attributes.

The Appendices include printer and paper specifications, a chart of Hexadecimal codes, a description of the optional Bidirectional Forms Tractor, Twin Sheet Feeder, and Envelope Feeder, accessories, and the loading and unloading of the Direct Access Vertical Format Unit (DAVFU).



73

1948

CONTENTS

CHAPTER 1	GENERAL INFORMATION	
1.1	Introduction	1-1
1.2	Unpacking and Installation	1-2
CHAPTER 2	PRINTER CONTROLS AND INDICATORS	
2.1	ON/OFF Switch	2-1
2.2	Control Panel	2-1
2.3	Error Code Indicator	2-4
2.4	Test Switches	2-6
2.5	Paper Controls	2-6
	Platen Knobs	2-6
	Paper Release Lever	2-6
	Copy Control Lever	2-7
CHAPTER 3	PRINTER OPERATION	
3.1	Printer Operation Summary	3-1
3.2	Removing a Ribbon Cartridge	3-2
3.3	Installing a Ribbon Cartridge	3-3
3.4	Changing the Print Wheel	3-5
3.5	Single-Sheet Paper Insertion	3-7
3.6	Continuous-Form Paper Insertion	3-8
	Monodirectional Forms Tractor (Forms Feeder)	3-8
	Bidirectional Forms Tractor	3-9
3.7	Cleaning the Printer	3-9
3.8	Reporting a Printer Problem	3-10
CHAPTER 4	SELECTING THE MODEL DW/22-20 FOR OUTPUT	
4.1	The SELECT Statement	4-1
	Device Type	4-2
	Unit Address	4-4
	Line Length	4-4
4.2	SELECT PRINT	4-6
4.3	SELECT LIST	4-8
4.4	SELECT CO (Console Output)	4-8
4.5	Combining SELECT Parameters	4-8
4.6	Deselecting the Model DW/22-20	4-9

CONTENTS (continued)

CHAPTER 5	FORMATTING OUTPUT WITH THE PRINT STATEMENT	
5.1	PRINT, PRINTUSING, and HEXPRINT Statements	5-1
	Zone Format	5-1
	Packed Format	5-2
	PRINTUSING Statement	5-4
5.2	The PRINT TAB(); Function	5-5
CHAPTER 6	FORMATTING OUTPUT WITH HEX CODES	
6.1	The HEX Function	6-1
6.2	Model DW/22-20 Control Codes	6-1
	Automatic Line Feed Suppression	6-2
	Backspace HEX(08)	6-2
	Carriage Return HEX(0D)	6-3
	Select HEX(02070E)	6-3
	Deselect HEX(02070F)	6-4
	Line Feed HEX(0A)	6-4
	Move (Absolute) HEX(E7XXXXYYYY)	6-4
	Power-On Reset HEX(020D0C030F)	6-6
	Processing Continuous Forms	6-6
	Reverse Index HEX(FA)	6-7
	Set Form Length HEX(020C0102YYYY0F)	6-7
	Set Home HEX(E4)	6-8
	Set Left Margin HEX(E8XXXX)	6-8
	Set Line Feed Spacing HEX(E9YYFF)	6-10
	Set Line Feed Spacing HEX(020A0102YYZZOE) or HEX(020A0102YYZZOF)	6-11
	Top of Form HEX(0C)	6-15
	Underscore	6-16
	Vertical Tab HEX(0B)	6-17
	Select Character Font HEX(0202aa0F)	6-18
	Down Load Font Description	6-18
	Select Pitch HEX(02090102aabb0F)	6-19
	Execute Partial Line Feed HEX(020Add0F)	6-19
APPENDICES		
Appendix A	Printer Specifications	A-1
Appendix B	Hexadecimal Codes	B-1
Appendix C	Decimal/Binary 2's Complement Conversion	C-1
	Introduction	C-1
	Conversion of Basic Numeric Values to 2's Complement	C-3
Appendix D	Trailing Spaces [HEX(20)] or the HEX(0D) Code in an Alpha Variable	D-1
	Trailing Spaces [HEX(20)] in an Alpha Variable	D-1
	HEX(0D) in an Alpha Variable	D-2

CONTENTS (continued)

Appendix E	Bidirectional Forms Tractor Option	E-1
	Introduction	E-1
	Installation Procedures	E-2
	Paper Insertion	E-3
	Print Registration	E-4
	Paper Specifications	E-5
	Bidirectional Forms Tractor Specifications	E-6
Appendix F	Twin Sheet Feeder Option	F-1
	Operational Features	F-2
	Installation Procedures	F-3
	Paper Insertion and General Maintenance	F-5
	Manual Operation of the Twin Sheet Feeder	F-6
	Programmable Operation of the Twin Sheet Feeder	F-6
	Paper Specifications	F-8
	Twin Sheet Feeder Specifications	F-9
Appendix G	Direct Access Vertical Format Unit (DAVFU)	G-1
	Introduction	G-1
	Vertical Format Control Utility (@ 2273VFU)	G-1
	Formatting Using the DAVFU	G-2
	DAVFU Control Codes	G-8
	DAVFU Errors	G-9
Appendix H	Envelope Feeder Option	H-1
	Overview	H-1
	Mounting and Removal	H-3
	Loading and Removing Envelopes	H-6
	Switch-controlled Operations	H-7
	Envelope Jams	H-8
	Programmable Operation	H-9
	General Care and Maintenance	H-11
	Envelope Feeder Specifications	H-12
	PREVENTIVE MAINTENANCE	H-15
	INDEX	INDEX-1

FIGURES

Figure 1-1	DW/20 Series Daisy Printer	1-1
Figure 2-1	Printer Control Panel	2-1
Figure 2-2	Printer Power Switch	2-1
Figure 2-3	Test Printout	2-3
Figure 2-4	Error Display and Switch Panel	2-4
Figure 2-5	Printer Error Codes	2-4
Figure 2-6	Platen Knob and Paper Release Lever	2-7
Figure 2-7	Copy Control Lever	2-7
Figure 3-1	Pressing the Cartridge Release Lever	3-2
Figure 3-2	Pressing the Cartridge Side Latch	3-3
Figure 3-3	Inserting Cartridge in Right Side Latch	3-3
Figure 3-4	Ribbon Position	3-4
Figure 3-5	Inserting Cartridge in Left Side Latch	3-4
Figure 3-6	Pressing Cartridge Locking Lever	3-5
Figure 3-7	Tilting the Print Wheel Assembly	3-6
Figure 3-8	Removing the Print Wheel ,.....	3-6
Figure 3-9	Tab and Alignment Slot Locations	3-9
Figure 3-10	Forms Feeder, Right Side	3-8
Figure 3-11	Forms Feeder, Left Side	3-8
Figure E-1	BFT-1: Bidirectional Forms Tractor	E-1
Figure E-2	Bidirectional Forms Tractor	E-3
Figure E-3	Tractor Rack and Rod Assemblies	E-4
Figure F-1	Twin Sheet Feeder	F-1
Figure F-2	Feeder Bins and Loading Lever	F-2
Figure F-3	Cable Attachment	F-3
Figure H-1	Overview of Envelope Feeder	H-1
Figure H-2	Envelope Feeder	H-3
Figure H-3	Installation of the Envelope Feeder	H-5
Figure H-4	Loading Envelopes	H-6
Figure H-5	Envelope Length and Height	H-10

TABLES

Table 2-1	Error Code Descriptions and Corrective Actions	2-5
Table 4-1	Device Types	4-2
Table 6-1	Conversion of Physical Distance to Hexadecimal Values Based on 1/48 Inch Increments	6-5
Table 6-2	Conversion of Physical Distance to Hexadecimal Values Based on 1/60 Inch Increments	6-9
Table 6-3	Conversion of Physical Lines Per Inch Values to Hexadecimal Form	6-13

TABLES (continued)

Table C-1	Decimal/Binary/Hexadecimal Conversion	C-1
Table G-1	DAVFU Data Loading Format	G-4
Table G-2	Sample DAVFU Tabulation Scheme	G-6
Table H-1	Envelope Length Specifications	H-11
Table H-2	Envelope Height Specifications	H-12

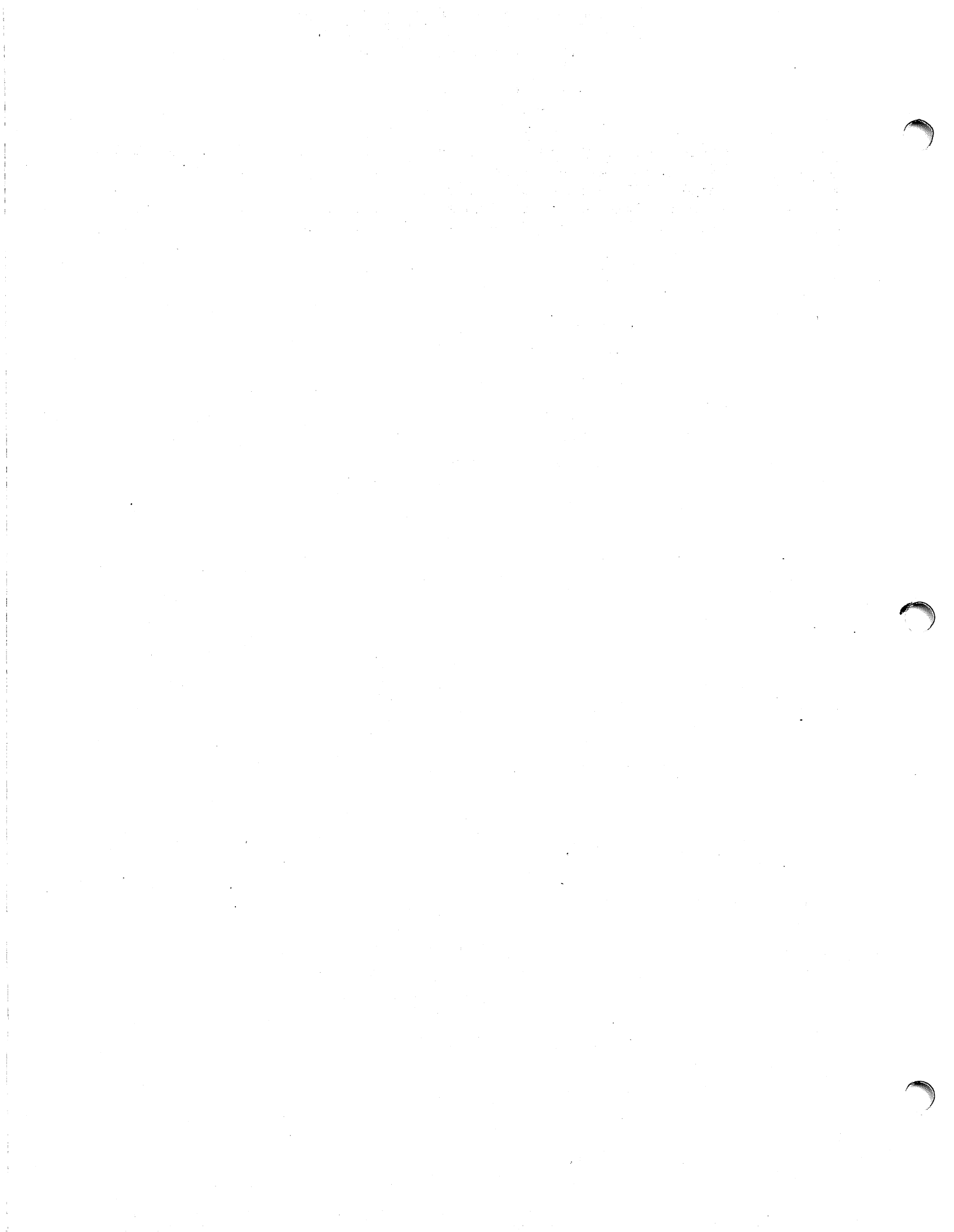

CHAPTER 1
GENERAL INFORMATION

1.1 INTRODUCTION

The DW/22-20 Series Daisy Printer, shown in Figure 1-1, provides low-cost, letter-quality output for all 2200 series systems.

The bidirectional DW/22-20 Printer uses interchangeable plastic daisy wheels containing 96 characters to print uppercase and lowercase letters, numerals, and special symbols and characters. You can obtain additional characters by overstriking, a print feature described in the 2200 Word Processing Operator's Guide (700-6937).

The printer can produce a 132-character line (10-pitch), a 158-character line (12-pitch), or a 196-character line (15-pitch) at an average rate of 20 characters per second (cps). You can use up to 6-part paper with the printer. Standard features include a print wheel that can be removed without taking off the ribbon cartridge, a Test pushbutton to check on printer operation, and Low and High print impression pushbuttons. Printer options include a Twin Sheet Feeder for single sheets, Monodirectional and Bidirectional Forms Tractors, and an Envelope Feeder for standard business-size envelopes.

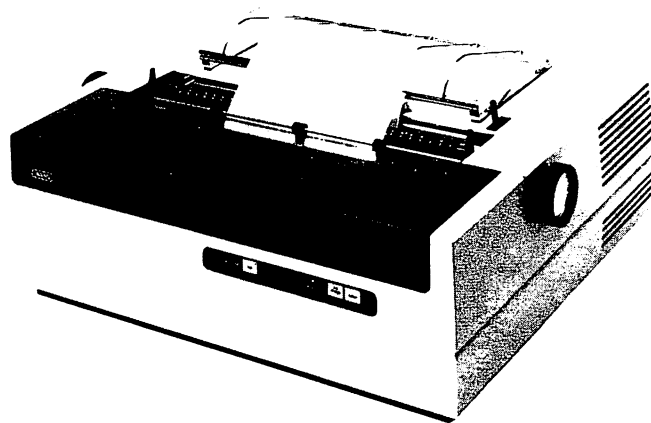

Figure 1-1. DW/22-20 Printer

1.2 UNPACKING AND INSTALLATION

The DW/22-20 must be unpacked, inspected, and installed by a qualified Wang service representative. Failure to follow this procedure voids the warranty.

CHAPTER 2
PRINTER CONTROLS AND INDICATORS

2.1 ON/OFF SWITCH

The printer ON/OFF switch is located at the left end of the rear panel (refer to Figure 2-1). To turn the printer on, press 1 on the switch. To turn the printer off, press 0 on the switch. When the printer is off, the Power lamp on the control panel goes out.

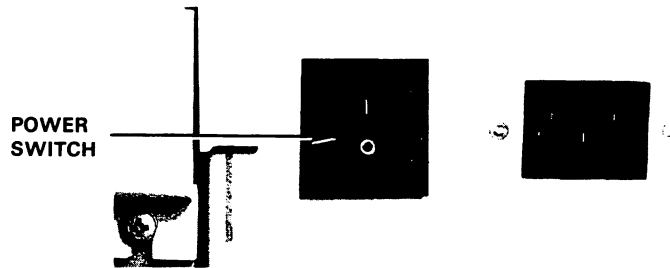

Figure 2-1. Printer Power Switch

2.2 CONTROL PANEL

The control panel on the front of the printer (refer to Figure 2-2) contains buttons and indicators for controlling printer operation. The indicators provide you with a visual cue of printer status. Whenever a Stop condition (Malfunction, Change Daisy, Change Ribbon, or Change Paper) is encountered, the printer stops printing and deselects (the Select lamp goes out). In addition, an audible tone sounds and an indicator displays the action required before printing can be resumed. Detailed descriptions of the buttons and indicators follow, together with any other actions you are required to take. After you have performed the appropriate action, reselect the printer by pressing the Select button.



Figure 2-2. Printer Control Panel

Select Button

Press the Select button to initially activate the printer or to restart it after it is deselected. The button lights to indicate that the printer is selected. When the printer is selected, the Low, High, and Test buttons are inactive. Before turning off power to the printer, deselect the printer by pressing the Select button.

Top of Page Button

The Top of Page button positions continuous-form paper to the top of the page. The button is operational only when the printer is deselected. Top of Page works in conjunction with the printer's DAVFU (Direct Access Vertical Format Unit). See Appendix G. The default tab setting in channel one of the DAVFU is 66 lines at 6 lines per inch for an 11-inch form. Thus, pressing the Top of Page button moves the paper to the first line of the next page.

However, if a DAVFU is downline loaded from the system, it is possible to locate the tab for channel one in a position or several positions other than the top of the page. Thus, when Top of Page is pressed, the paper will move to the first line position set in channel one of the DAVFU.

NOTE

The distance from the top edge of continuous-form paper to the line where printing begins is set during paper insertion. Refer to Section 3.6 for instructions on how to set this distance.

The Top of Page button is also used with the optional Twin Sheet Feeder to eject a sheet of paper from the printer (see Appendix F).

Change Daisy Indicator

Anytime a change font escape sequence (see Section 6.2) is encountered in the text being printed, the Change Daisy lamp lights, an audible tone sounds, and the printer automatically deselects. When this occurs, change the print wheel using the procedure described in Section 3.4; then press Select to continue printing.

Change Paper Indicator

When the printer nears the end of the last sheet of paper, the Change Paper lamp lights, a tone sounds, and the printer automatically deselects. (To continue printing one or more lines on the sheet, press Select once for each line to be added.) Use the platen knob to remove the remaining paper from the printer. Insert additional paper into the printer using the procedures described in Sections 3.5 and 3.6; then press Select to continue printing.

If the cause of the malfunction is not obvious, reselect the printer by pressing the Select button. If it will not reselect, power off the printer, wait a few seconds, then power on the printer and reselect it. If the Malfunction indicator remains on, lift the front cover and note the number displayed on the error indicator. Refer to Section 2.3 for the location of this indicator and the action required to correct the malfunction.

2.3 ERROR CODE INDICATOR

When a printer malfunction occurs, the printer stops, the front panel Malfunction indicator lights, and an error code numeral is displayed on the indicator located below the printer top cover (refer to Figure 2-4). Error codes are printed on a label located inside the printer (refer to Figure 2-5).

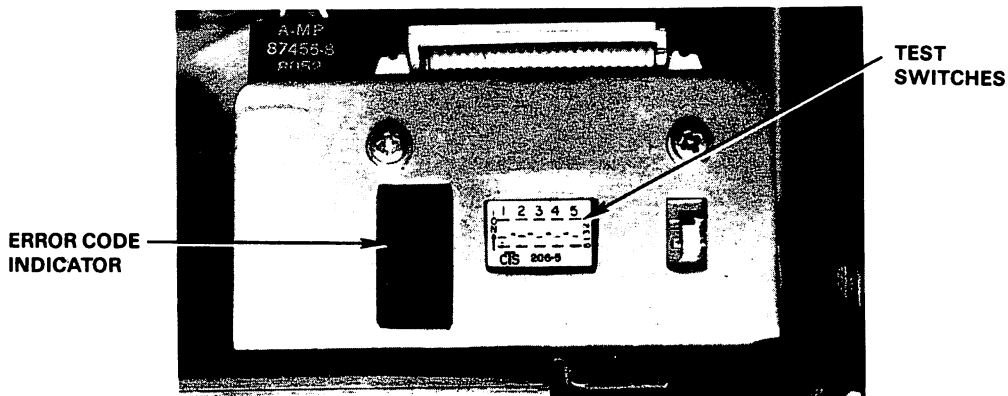

Figure 2-4. Error Display and Switch Panel

ERROR CODES		WANG
0	COVER OPEN	
1	CPU	
2	DATA LINK BOARD	
3	DRIVER CARD	
4	DAISY HOME	
5	CARRIAGE SENSOR	
6	FEEDER	
7	N/A	
8	DAVFU LOAD	
9	SKIP TO UNDEFINED CHANNEL ON DAVFU	
F	FRONT LOAD	

Figure 2-5. Printer Error Codes

The printer error codes, plus the possible causes for each error and corrective actions to clear the malfunctions, are listed in Table 2-1.

Table 2-1. Error Code Descriptions and Corrective Actions

Error Code	Error Location	Description and Corrective Action
0	COVER OPEN	If the printer top cover is raised, the printer stops functioning. This feature is included as a safety measure to protect the operator. Close the cover and press Select to start the printer.
1	CPU	This error indicates a malfunction in the printer's microprocessor. Contact a Wang service representative.
2	DATA LINK BOARD	Contact a Wang service representative.
3	DRIVER CARD	This error indicates a malfunction in the printer. Contact a Wang service representative (refer to Section 3.8).
4	DAISY HOME	This error indicates a malfunction in the printer. Contact a Wang service representative (refer to Section 3.8).
5	CARRIAGE SENSOR	If the carriage is unable to move because of a paper jam or other obstruction, or because of a faulty carriage sensor, this lamp lights. Try to remove the jammed piece of paper using the Top of Page button. Switch off the printer power. If there is an obstruction in the carriage, such as a foreign object or piece of paper, remove it. Turn on the printer and then press Select. If the same error is indicated, contact a Wang service representative (refer to Section 3.8).
6	FEEDER	If a Twin Sheet Feeder and an Envelope Feeder are both connected to the printer at the same time, this indicator lights. Disconnect one of the feeders from the printer, switch off the printer power, then switch the power on.
8	DAVFU	An error has been made in loading a DAVFU from the 2200 system. The printer is automatically deselected, the alarm is sounded, and the malfunction indicator is lit. When the printer is reselected, the default DAVFU will be loaded.

Table 2-1. Error Code Descriptions and Corrective Actions (continued)

Error Code	Error Location	Description and Corrective Action
9	UNDEFINED DAVFU CHANNEL	The system attempted to skip to an undefined channel of the DAVFU. When the error code is displayed, the printer is deselected, the alarm is sounded, and the malfunction indicator is lit. When the printer is reselected, the skip to channel command is ignored.
F	FONT LOAD	An error has been made in the downline loadable font. When the error code is displayed, the printer is deselected, the alarm is sounded, and the malfunction indicator is lit. When the printer is reselected, the downline loadable font is set to the internal default font.

2.4 TEST SWITCHES

A group of Test switches, located under the printer cover and shown in Figure 2-4, are intended for use by the customer service engineer. These switches should all be set to the Off position for normal printer operation.

2.5 PAPER CONTROLS

The paper controls include two platen knobs, a paper release lever, and a copy control lever. The controls are described in the following paragraphs.

Platen Knobs

The platen knobs, located at the left and right ends of the paper carriage and shown in Figure 2-6, are used to insert paper into the printer. When the left-hand platen knob is pushed inward, a fine adjustment can be made (upward or downward) to the paper position. This platen knob is also used in conjunction with the Top of Page button to set the top-of-form position when using continuous form paper. Refer to Section 3.6, Steps 7 and 8, to set the top of form.

Paper Release Lever

The paper release lever, located on the top right side of the printer and shown in Figure 2-6, releases the paper so that it can be moved in any desired direction. The normal operating position for this lever is toward the rear of the printer; the release position is toward the front of the printer.

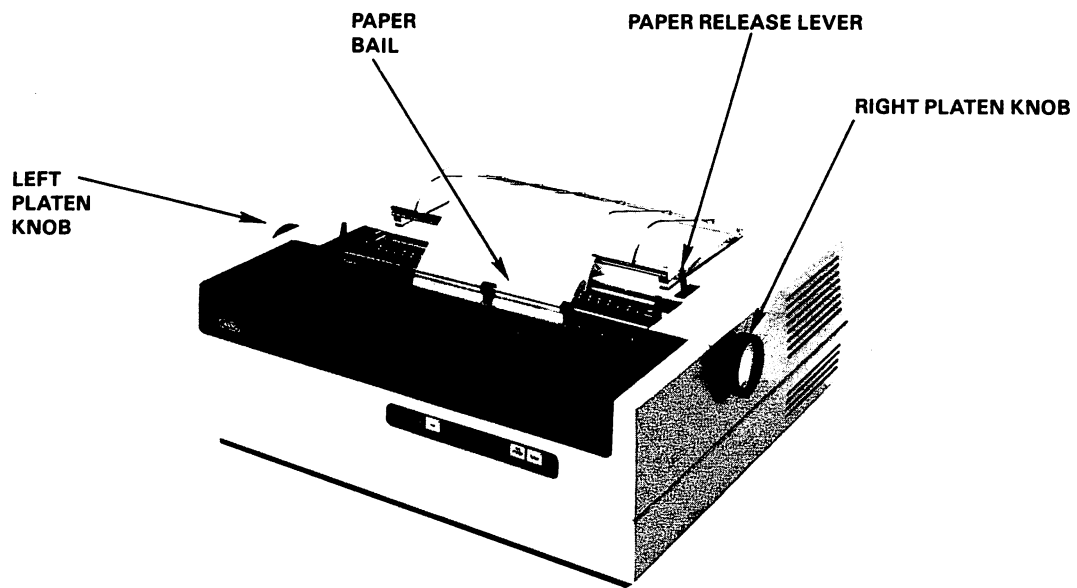

Figure 2-6. Platen Knob and Paper Release Lever

Copy Control Lever

The copy control lever, shown in Figure 2-7, is located below the daisy wheel carriage and is accessible by lifting the top cover of the printer. This lever is used to accommodate various thicknesses of paper. For single-sheet paper, the lever should be set to Position 1. For multipart forms, the lever should be set to Position 2 or 3. If thick paper or multipart forms bind or do not feed properly in the printer, set the copy control lever to a higher number.

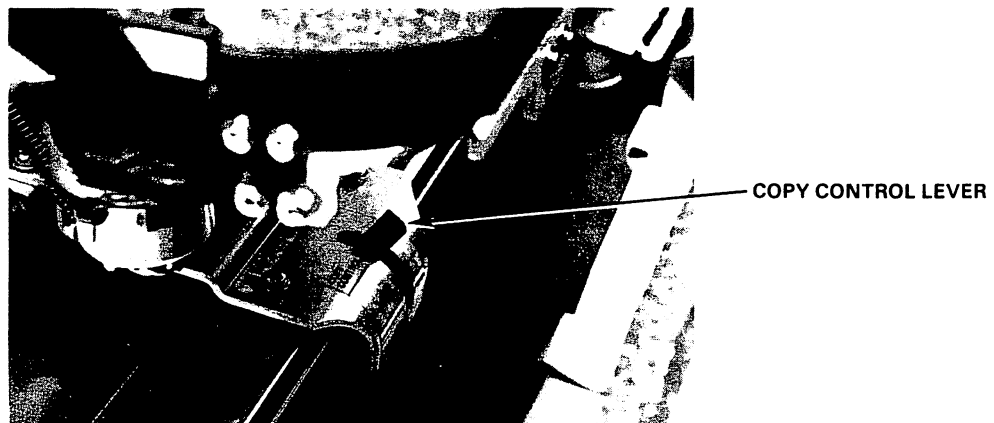
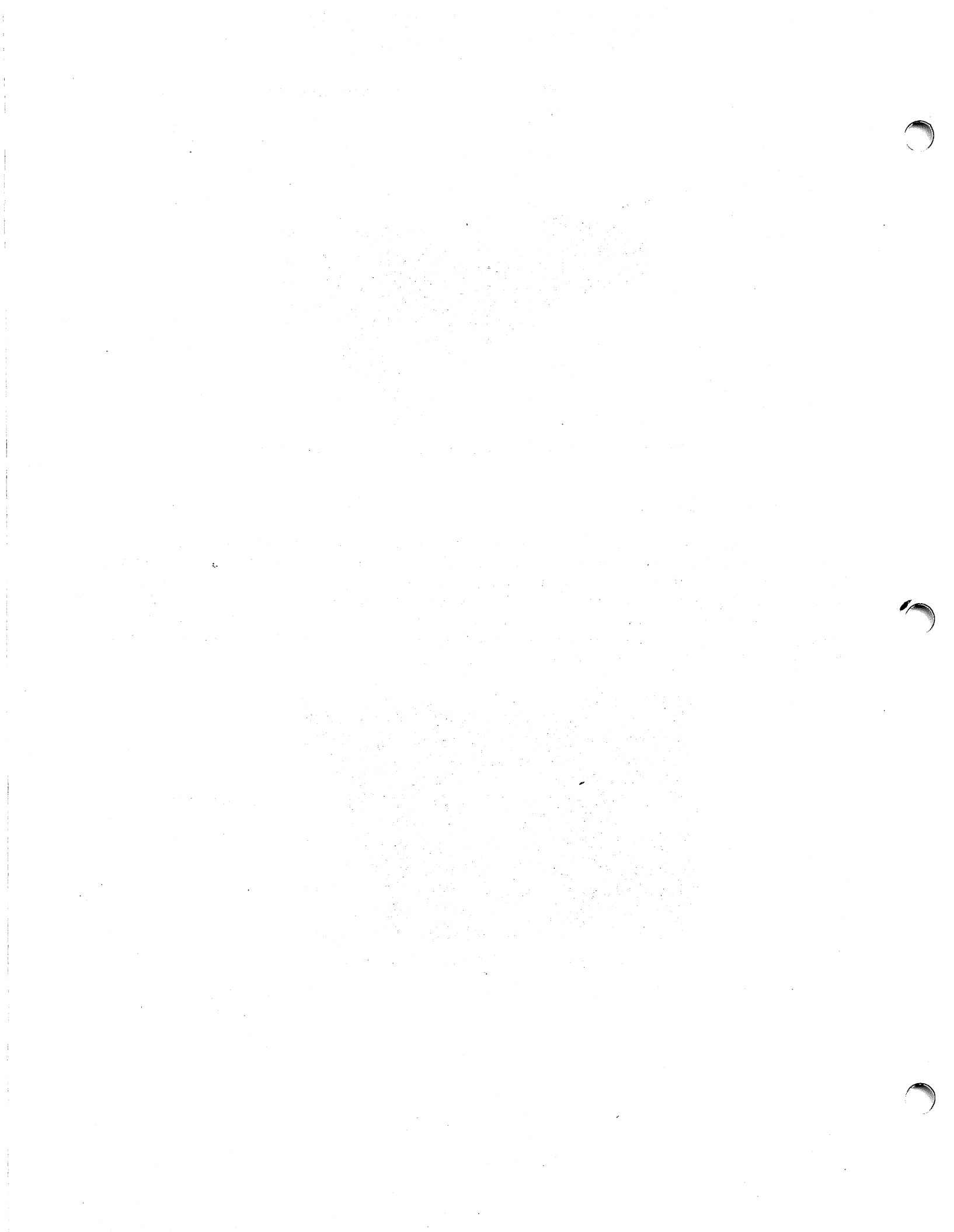

Figure 2-7. Copy Control Lever



CHAPTER 3
PRINTER OPERATION

3.1 PRINTER OPERATION SUMMARY

To power on your 2200 system, perform the following steps:

1. Connect all power cords to a source of electrical power, and make sure the two printer signal cables are connected to the Printer Controller Board installed in the CPU chassis of your system.
2. Turn on the system power switches in the sequence specified in your system's Introductory Manual.

Perform the following steps to operate the printer:

1. Plug the printer into a source of electrical power.
2. Turn on the system and then the printer. Be sure there is a ribbon cartridge (refer to Section 3.3) and a daisy wheel (refer to Section 3.4, Step 4) installed in the printer.
3. Insert paper into the printer. To insert single-sheet paper, refer to Section 3.5; for continuous-form paper, refer to Section 3.6. To protect the platen, always operate the printer with paper inserted into it.
4. If using the printer with 2200 WP software, complete the Print Document menu and then press EXECUTE.
5. Press SELECT to enable the printer to begin printing.

NOTE

If power to the printer is shut off while a word processing document is printing, perform the following steps after the power has been turned on again: First cancel the print request for the document, and then enter a new print request. Do not shut off power during the printing operation because other print requests in the print queue might also be cancelled.

3.2 REMOVING A RIBBON CARTRIDGE

Use the following procedure to remove a ribbon cartridge from the printer:

NOTE

The installation and removal procedures for the DW/22-20 ribbon cartridge differs slightly from other Wang printers. Therefore, please disregard the instructions printed on the ribbon cartridge package.

1. Deselect the printer by pressing the Select button. The Select lamp goes out. (If the Change Ribbon lamp is on, the printer is already deselected.)
2. Open the front cover by gently lifting the back edge of the printer front cover.
3. Push the cartridge release lever (refer to Figure 3-1) toward the rear of the printer until it clicks into position.

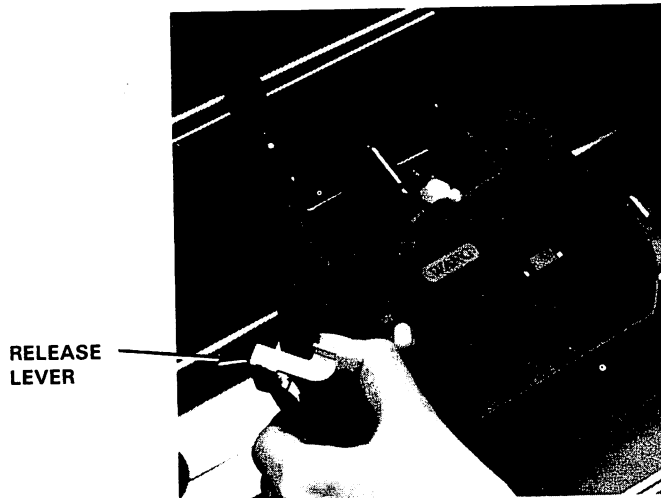

Figure 3-1. Pressing the Cartridge Release Lever

4. Push the left cartridge side latch (refer to Figure 3-2) to the left, releasing the cartridge.

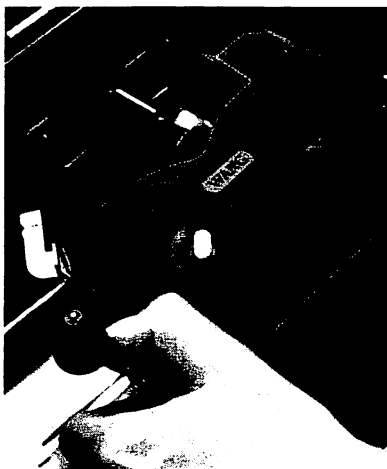

Figure 3-2. Pressing the Cartridge Side Latch

5. Using both hands, remove the ribbon cartridge by gently lifting it up and out of the printer.

3.3 INSTALLING A RIBBON CARTRIDGE

Use the following procedure to install a new ribbon cartridge in the printer:

1. Rotate the ribbon advance knob on the new cartridge clockwise until the ribbon is taut.
2. Insert the pin on the right end of the ribbon cartridge into the right side latch on the print head carriage (refer to Figure 3-3).

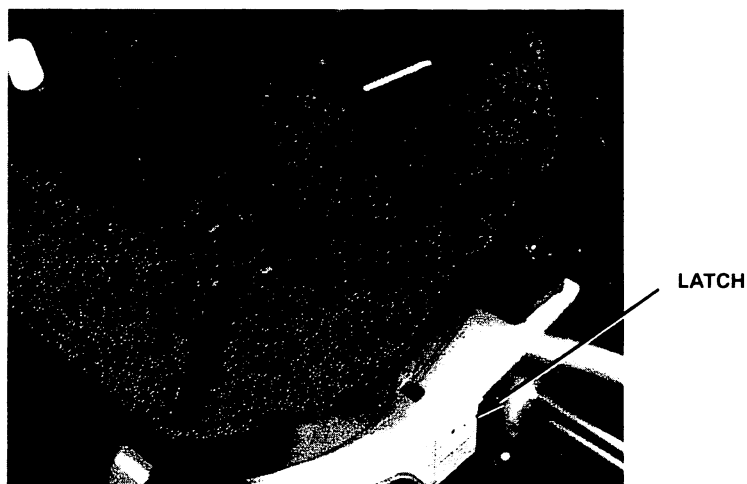

Figure 3-3. Inserting Cartridge in Right Side Latch

Position the cartridge so that the exposed length of ribbon is behind the two ribbon guide posts located in front of the print wheel (refer to Figure 3-4).

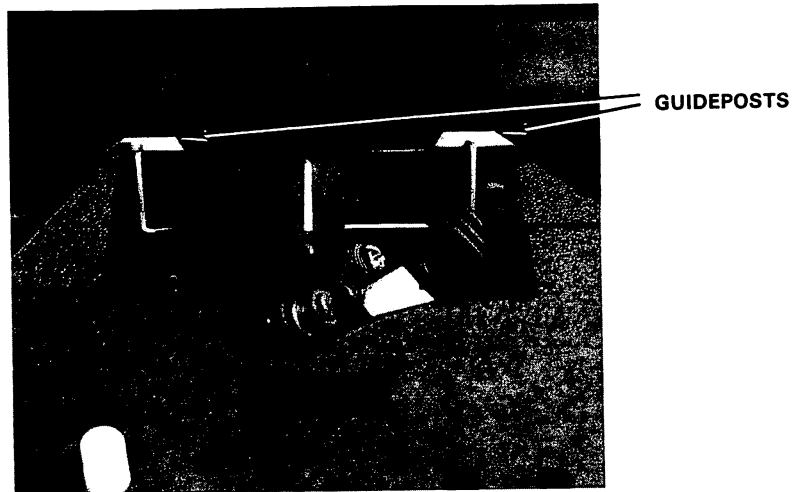

Figure 3-4. Ribbon Position

3. Press downward on the left side of the cartridge until the pin on the left side of the cartridge snaps into place in the left side latch (refer to Figure 3-5).

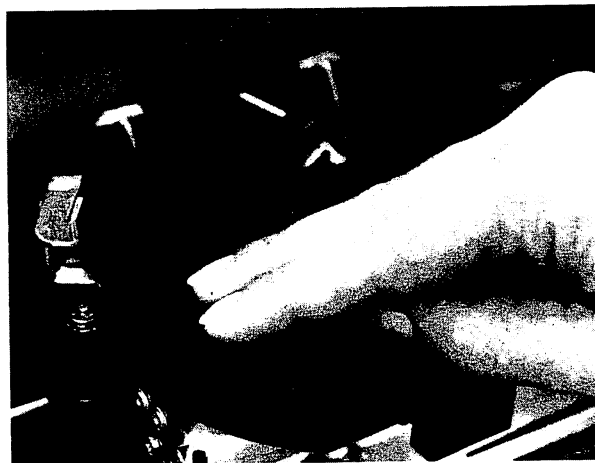

Figure 3-5. Inserting Cartridge in Left Side Latch

4. Push the locking lever, shown in Figure 3-6, toward the rear of the printer, to snap the release lever forward into place.

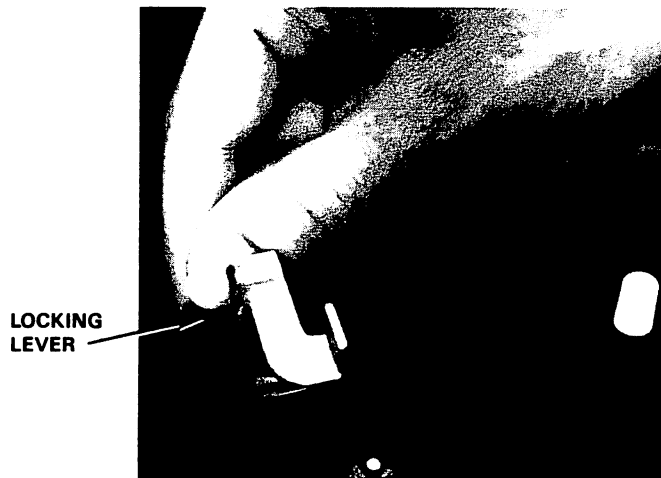

Figure 3-6. Pressing Cartridge Locking Lever

5. Lower the paper bail and close the printer cover. The printer will not print with the cover open.
6. Press the Select button to continue printing.

3.4 CHANGING THE PRINT WHEEL

Use the following procedure to remove and install a print wheel in the printer. Use care when removing, installing, or storing a print wheel. Use plastic wheels only, as metal print wheels can damage the printer.

1. Open the front cover by gently lifting the back edge of the printer front cover.
2. Grasp the print hammer and gently tilt the print wheel assembly away from the platen (refer to Figure 3-7).

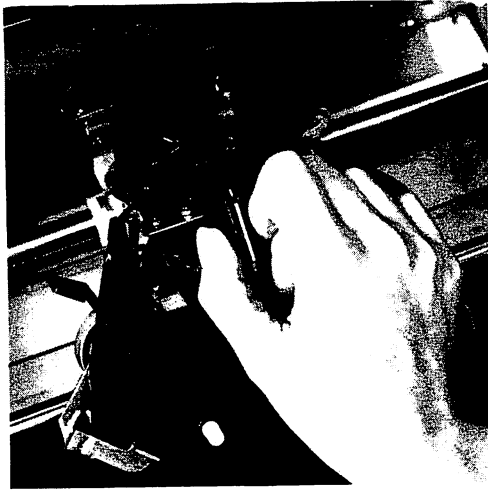

Figure 3-7. Tilting the Print Wheel Assembly

3. To remove the print wheel, grasp the rubber hub and gently pull the print wheel upward and away from the printer (refer to Figure 3-8).



Figure 3-8. Removing the Print Wheel

4. To install a print wheel, hold the wheel so that the edge of the wheel is under the ribbon. Then rotate the wheel so the tab protruding from the shaft hub lines up with the alignment slot on the print wheel (refer to Figure 3-9). Push the wheel firmly onto the end of the print wheel shaft, making sure the tab enters the alignment slot on the wheel. Then grasp the print hammer and push it toward the platen until it clicks into position.

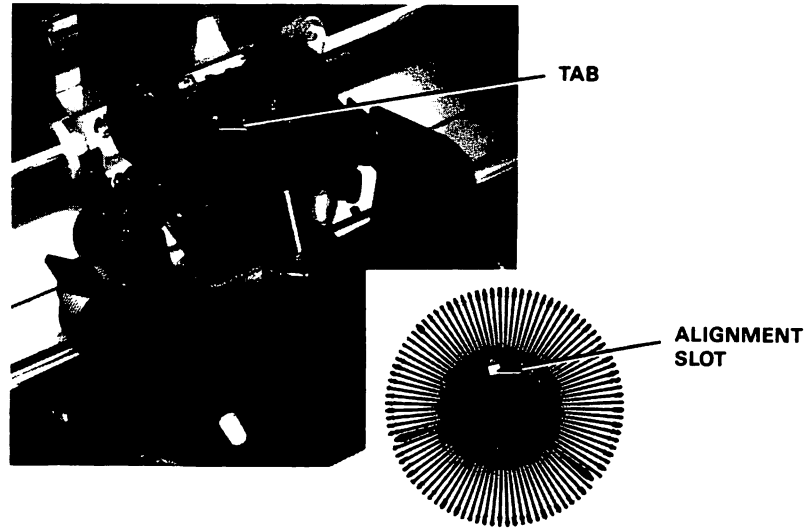

Figure 3-9. Tab and Alignment Slot Locations

3.5 SINGLE-SHEET PAPER INSERTION

Loading single-sheet paper in the printer is similar to loading paper in a standard typewriter. Paper loading controls are shown in Figure 2-6. Use the following procedure to load single-sheet paper into the printer:

1. Position the paper release lever (located on the top right side of the printer) to the rear.
2. Pull the paper bail forward, away from the platen.
3. Insert the paper behind the platen. Be sure the paper is also threaded behind (to the rear of) the paper scale rod. If the paper is threaded in front of this rod, the change paper sensor will not function. Turn the platen knob until the paper comes around and up in front of the platen.
4. Position the paper release lever to its most forward position and align the paper.
5. After the paper is correctly positioned, return the paper release lever to the rear position. Push the paper bail against the platen. To move the paper upward or downward a small amount, push the left platen knob inward, rotate the platen knob to position the paper as desired, and then release the platen knob.

3.6 CONTINUOUS-FORM PAPER INSERTION

You can use continuous-form paper with the DW/22-20 printer when the optional monodirectional or bidirectional paper tractor is mounted on the printer.

Monodirectional Forms Tractor (Forms Feeder)

Use the following instructions to mount the Forms Feeder and insert paper in the printer:

1. Pull the paper bail forward (away from the platen), and pull the paper release lever to the forward position.
2. Center the Forms Feeder over the printer with the white latch release buttons (refer to Figures 3-10 and 3-11) facing the top of the printer.

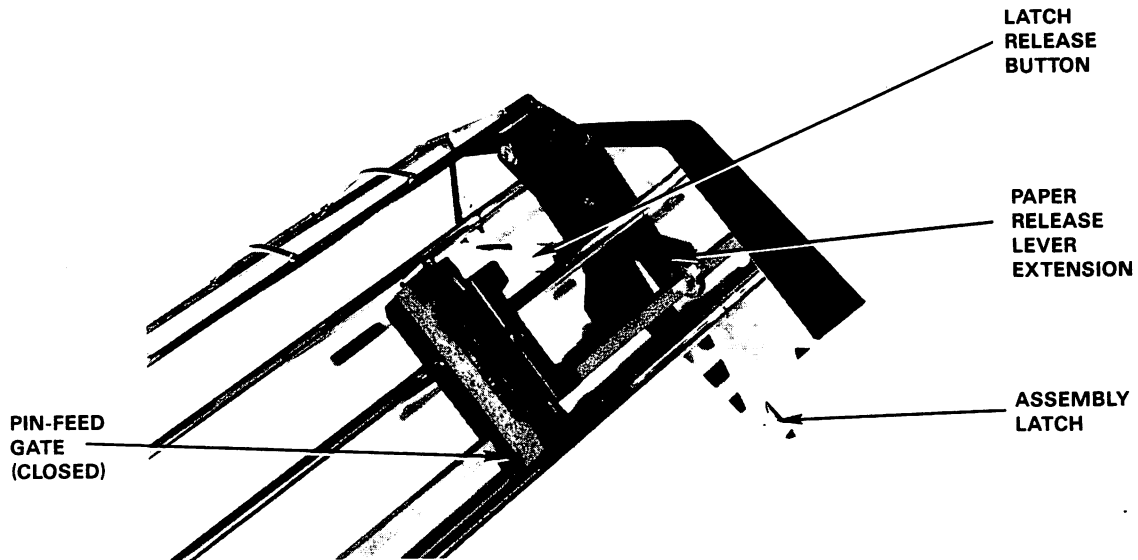

Figure 3-10. Forms Feeder, Right Side

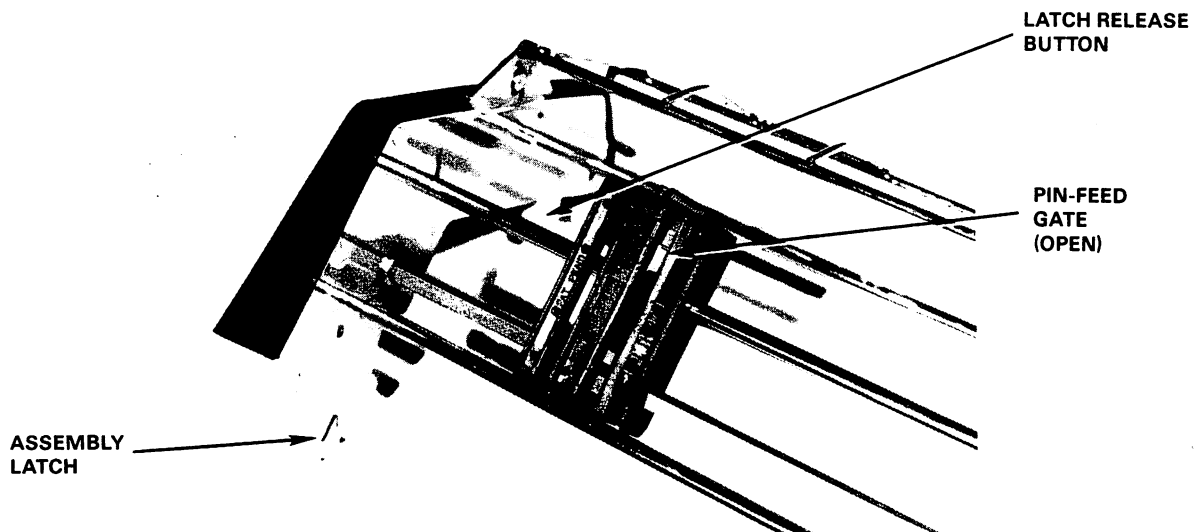

Figure 3-11. Forms Feeder, Left Side

3. Press in both latch release buttons on the Forms Feeder and lower the feeder onto the platen shaft. At the same time, position the paper release lever extension (refer to Figure 3-10) over the paper release lever. The latches fit readily onto the platen shaft at the right and left ends of the platen. Release the latch release buttons to lock the Forms Feeder into place.
4. Push the paper release lever to the rear by gently pulling up on the upper paper rack. Insert continuous-form paper between the upper and lower paper racks and down behind the platen. Be sure the paper is also threaded behind (to the rear of) the paper scale rod. If the paper is threaded in front of this rod, the change paper sensor will not function. Turn the platen knob until the paper comes around and up in front of the platen.
5. Position the paper release lever forward and align the paper.
6. Open the pin-feed gates on the Forms Feeder by gently pulling forward on the front of the gates. Align the holes on the paper with the pins on the feeder. To change paper width or margins, pull the side(s) of the pin-feed gate(s) forward, adjust the gate(s), align the holes on the paper with the pins on the Feeder, and push the side(s) of the gate(s) back into operating position. Close the pin-feed gates by gently pushing them back.
7. Turn the platen knob to position the paper to where the first line of printing is to begin. To make fine adjustments in paper position, press the left platen knob inward. Then rotate the platen knob as required.
8. After the top of page position has been set, press and hold the left platen knob inward. Then press the Top of Page button. The paper drive motor now rotates to the top-of-page position and then stops. After it stops, release the left platen knob.
9. When printing, the paper should exit over the top of the upper paper rack toward the back of the printer.

Bidirectional Forms Tractor

Instructions for mounting the bidirectional forms tractor and a paper insertion procedure are contained in Appendix E.

3.7 CLEANING THE PRINTER

Use the following materials to clean the platen, feed rollers, print wheel, and plastic parts on the printer:

- Use platen cleaner to clean the platen or feed rollers. Do not use alcohol.

- The print wheel does not need cleaning under normal operating conditions. Slight ink build-up is normal, especially with a new ribbon. Only unusually severe operating conditions make print wheel cleaning necessary. When necessary, clean the print wheel with ethyl or isopropyl alcohol. Do not use methyl alcohol.
- Do not use platen cleaner to clean plastic parts. Clean plastic parts with ethyl or isopropyl alcohol. Do not use methyl alcohol.

3.8 REPORTING A PRINTER PROBLEM

Supply the following information on the phone when reporting a printer problem:

1. If the Malfunction indicator is lit, what error number is displayed on the error indicator?
2. How does the printer respond when the Test button is pressed?

CHAPTER 4
 SELECTING THE MODEL DW/22-20 FOR OUTPUT

4.1 THE SELECT STATEMENT

You must use the BASIC language SELECT statement to select the Model DW/22-20 as the output device. You can use a SELECT statement either in the Immediate mode or as a statement within a program. When used to select the printer, the syntax of the SELECT statement requires that it contain a BASIC verb (PLOT, PRINT, LIST, or CO), and a 3-digit Device Address code (xyy) consisting of a device type (x) and a unit address code (yy). You can also specify line length in printing operations.

Example 1:

```
:100 SELECT PRINT 215 (132)
device type  ┌──┬──┐
unit address ┌──┬──┐
line length  └──┴──┘
```

If line length is not specified in a SELECT PRINT, SELECT LIST, or SELECT CO statement, the line length defaults to the standard default width of the CRT. In a system with a 16 x 80 CRT, the standard line length is 80 characters; and it is 64 characters with a 16 x 64 CRT.

Example 2:

```
:SELECT PRINT 215
:10 PRINT "THE MODEL DW/22-20 PRINTER BIDIRECTIONALLY PRINTS
132 CHARACTERS ON A FULL LINE WHEN 10-PITCH IS SELECTED
AND 158 CHARACTERS ON A FULL LINE WHEN 12-PITCH IS
SELECTED."
:RUN (EXEC)
```

Output: (Line length default = 80 characters with a 16 x 80 CRT)

THE MODEL DW/22-20 PRINTER BIDIRECTIONALLY PRINTS 132 CHARACTERS ON A FULL LINE WHEN 10-PITCH IS SELECTED AND 158 CHARACTERS ON A FULL LINE WHEN 12-PITCH IS SELECTED.

Device Type

The device type digit (x) in the Device Address code determines which of the system I/O routines are used to control the printer. The Model DW/22-20 automatically executes a line feed (i.e., advances the paper to a new line) following the execution of a carriage return; therefore it is usually selected with a device type of 2 when printing (refer to Table 4-1). Generally, carriage return commands are initiated from the Wang System CPU. At the end of a full character line (132 or 157 characters), the printer automatically prints characters in its buffer and executes a carriage return/line feed.

Table 4-1. Device Types

Type	Operation
0	<p>Device Type 0 usually addresses devices that do not automatically execute a line feed after a carriage return. With this device type, your Wang CPU executes a line feed after each carriage return; therefore, when this device type is selected, the printer output is double spaced because the printer also executes a line feed after each carriage return.</p> <p>Example:</p> <pre> :SELECT PRINT 015 (80) :10 FOR I=1 TO 4 :20 PRINT "AABCCDDEEFFGGHHIIJJKLLMMNNOOPPQQRRSSTTUUVVWW" :30 NEXT I :RUN (EXEC) </pre> <p>Output:</p> <pre> AABCCDDEEFFGGHHIIJJKLLMMNNOOPPQQRRSSTTUUVVWW AABCCDDEEFFGGHHIIJJKLLMMNNOOPPQQRRSSTTUUVVWW AABCCDDEEFFGGHHIIJJKLLMMNNOOPPQQRRSSTTUUVVWW AABCCDDEEFFGGHHIIJJKLLMMNNOOPPQQRRSSTTUUVVWW </pre>
2	<p>Device Type 2 addresses devices that automatically execute a line feed after a carriage return and is the device type generally used with the printer for PRINT, LIST, and CO operations. With this device type, output is single spaced since no additional line feed is issued by the CPU.</p>

Table 4-1. Device Types (continued)

	<p>Example:</p> <pre>:SELECT PRINT 215 :10 FOR I=1 TO 5 :20 PRINT "AABCCDDEEFFGGHHIIJJKLLMMNNOOPPQQRRSSTT" :30 NEXT I :RUN (EXEC)</pre> <p>Output:</p> <pre>AABCCDDEEFFGGHHIIJJKLLMMNNOOPPQQRRSSTT AABCCDDEEFFGGHHIIJJKLLMMNNOOPPQQRRSSTT AABCCDDEEFFGGHHIIJJKLLMMNNOOPPQQRRSSTT AABCCDDEEFFGGHHIIJJKLLMMNNOOPPQQRRSSTT AABCCDDEEFFGGHHIIJJKLLMMNNOOPPQQRRSSTT</pre>
<p>4</p>	<p>Device Type 4 usually addresses devices without automatic carriage returns such as plotters. When addressing the Model DW/22-20 for printing operations in a SELECT PRINT statement, it suppresses the character count in the CPU and the automatic carriage return issued by the CPU at the end of PRINT, PRINTUSING, and HEXPRINT statements that contain no trailing punctuation. Usually, when the number of characters in the buffer equals the line length in a SELECT PRINT statement, a carriage return is executed. Device Type 4, however, suppresses this feature by not executing a carriage return when the number of characters equals the line length. The carriage return is not executed until the print buffer is full (and a line is printed) or when the carriage return code HEX (0D) is encountered in the program.</p> <p>Example 1:</p> <pre>:10 SELECT PRINT 415 :20 FOR I=1 TO 15 :30 PRINT "AABCCDDEE" :40 NEXT I :RUN (EXEC)</pre> <p>Output: (Reduced)</p> <p>Example 2:</p> <pre>:10 SELECT PRINT 415 (124) :20 FOR I=1 TO 5 :30 PRINT "AABCC" :40 PRINT HEX(0D) :50 NEXT I :RUN (EXEC)</pre>

Table 4-1. Device Types (continued)

Output:
AABBCC
AABBCC
AABBCC
AABBCC
AABBCC

Unit Address

The unit address of the Model DW/22-20 controller is preset to 15 by Wang Laboratories before the unit is shipped, and must be the address used in SELECT statements dealing with the printer (e.g., SELECT PRINT 215). If a second Wang printer is used on the same CPU, it is assigned device address 16 by the Wang service representative who installs the system.

Line Length

Line length is an optional parameter in a SELECT PRINT, SELECT LIST, or SELECT CO statement which specifies the number of characters to be sent out to the printer before the system sends out a carriage return and resets the internal line count. Line length is usually varied to accommodate paper of different widths. In the SELECT statement, line length is indicated in the parentheses following the Device Address code. Line length is not usually specified in the SELECT PLOT statement. For example:

SELECT PRINT 215 (80)	Selects the Model DW/22-20 for printing and sets line length to 80
SELECT CO 215 (64)	Selects the Model DW/22-20 for console output and sets line length to 64
SELECT LIST 215 (150)	Selects the Model DW/22-20 for listing a program and sets line length to 150

If a line length is not specified for PRINT, LIST, or CO, either the default or the last line lengths selected for these operations are used. Note that the default line length set during Master Initialization is 64 characters (80 characters with an 80-column CRT). The maximum line length which can be specified in a SELECT statement is 255. However, the use of a line length greater than 196 characters is not recommended. A longer line count typically produces two carriage returns: one done automatically by the printer when a full line of characters has been printed, another sent out by the system when the line count specified in the SELECT PRINT statement is exceeded. Specifying a shorter line length causes a carriage return to be sent out when the line count is exceeded.

Example 1:

```
:5 REM EXAMPLE OF USING A LINE LENGTH LESS THAN THE MAXIMUM
  NUMBER OF CHARACTERS IN THE PRINT LINE
:10 SELECT PRINT 215 (5)
:20 PRINT "THE MODEL DW/22-20 PRINTS UP TO 196 CHARACTERS PER LINE"
:RUN (EXEC)
```

Output:

```
THE M
ODEL
DW/22
-20 P
RINTS
UP TO
196 C
HARAC
TERS
PER L
INE
```

Note that embedded spaces in the line are included in the line count.

Example 2:

```
:10 REM EXAMPLE OF USING A LINE LENGTH GREATER THAN 196
:20 SELECT PRINT 215 (219)
:30 PRINT "THIS LINE INCLUDING EMBEDDED SPACES HAS A TOTAL OF 223
  CHARACTERS; CONSEQUENTLY, SINCE IT IS LONGER THAN THE LINE
  LENGTH OF 219 (GREATER THAN 196) SPECIFIED IN STATEMENT NUMBER
  20 IT WILL PRINT OUT PREDICTABLY IN THREE LINES."
:RUN (EXEC)
```

Output: (Condensed)

The line length setting is used by the Wang system to generate an automatic carriage return when a line exceeds the specified line length and no carriage return is supplied by the program. As a line is output on the printer, the CPU keeps a count of the number of characters sent (line count). If this line count equals the current value of the line length before the output line is complete, a carriage return is transmitted to the printer, the line count is reset to zero, and the unfinished output is continued on the next line.

Example 3:

```
:SELECT PRINT 215(20)
:10 PRINT "ABCDEFGHIJKLMN OPQRSTUVWXYZ"
:RUN (EXEC)
```

Output:

```
ABCDEFGHIJKLMN OPQRST
UVWXYZ
```

If the output is complete and a carriage return is transmitted before the line count equals the line length, the system automatically resets the line count to zero for the start of a new line. (A PRINT statement with no trailing comma or semicolon causes a carriage return to be executed at the end of the output.)

Example 4:

```
:10 REM EXAMPLE OF PRINT STATEMENTS WITH NO TRAILING  
    COMMA OR SEMICOLON  
:20 SELECT PRINT 215(30)  
:30 PRINT "KEEP"  
:40 PRINT "OUT"  
:RUN (EXEC)
```

Output:

```
KEEP  
OUT
```

The line count is reset to zero under any one of the following conditions:

1. The line count equals the line length.
2. A carriage return is output when a PRINT, PRINTUSING, or HEXPRINT statement with no trailing punctuation (colon or semicolon) is executed.
3. The RESET switch on the system keyboard is pressed.
4. A Clear command is executed.
5. The system is master initialized.
6. A SELECT PRINT statement is executed.

4.2 SELECT PRINT

```
:SELECT PRINT 215 (132)
```

This statement selects the printer with Device Address Code 215 for all program output resulting from the execution of PRINT, PRINTUSING, or HEXPRINT statements. Output resulting from PRINT and HEXPRINT statements entered in the Immediate mode appear on the CRT unless the printer is also selected for CO (refer to Section 4.4).

Example 1:

Program Mode

```
:10 SELECT PRINT 215
:20 PRINT "N", "2 to the Nth"
:25 PRINT
:30 FOR X=0 TO 8
:40 PRINT X, 2 X
:50 NEXT X
```

Immediate Mode

```
:SELECT PRINT 215
:20 PRINT "N", "2 to the Nth"
:25 PRINT
:30 FOR X=0 TO 8
:40 PRINT X, 2 X
:50 NEXT X
```

When either of these programs is executed, the printer output is as follows:

N	2 to the Nth
0	1
1	2
2	4
3	8
4	16
5	32
6	64
7	128
8	256

Example 2:

```
:10 SELECT PRINT 215
:20 X=7:Y=2.0:Z=5
:30 PRINTUSING 40, X;Y;Z
:40 % ##.#
:RUN (EXEC)
```

Output:

7.0 2.0 5.0

Example 3:

```
:5 DIM A$25
:10 SELECT PRINT 215 (40)
:20 A$ = "THE DW/22-20 PRINTER"
:30 HEXPRINT A$
:RUN (EXEC)
```

Output:

5448452044572F32322D3230205052494E544552

4.3 SELECT LIST

```
:SELECT LIST 215
```

This statement selects the printer with Device Type Code 215 for all LIST operations. Output from the Disk Catalog Index can also be listed on the printer.

NOTE

The default address for LIST operations is 005 (the CRT).

Example:

```
:SELECT LIST 215
:5 DIM A$25
:10 REM AN EXAMPLE USING THE PRINTER FOR LISTING
:100 A$ = "MODEL DW/22-20 PRINTER"
:999 PRINT A$
:8900 END
:LIST (EXEC)
```

Output:

```
5 DIM A$25
10 REM AN EXAMPLE USING THE PRINTER FOR LISTING
100 A$ = "MODEL DW/22-20 PRINTER"
999 PRINT A$
8900 END
```

4.4 SELECT CO (CONSOLE OUTPUT)

```
:SELECT CO 215 (40)
```

This statement selects the printer with Device Type Code 215 and a line length of 40 for all console output. This includes all system displays, such as the READY message output from STOP and END statements; any data keyed in on the keyboard and entered into the CPU; and all output from Immediate mode operations, TRACE statements, and error messages.

4.5 COMBINING SELECT PARAMETERS

It is possible to combine parameters in a SELECT statement.

Example:

```
SELECT PRINT 215 (100), LIST 215(80), CO 215 (112)
```

However, it is not possible to select two output devices with the same parameter. For example, the following statement produces a listing of programs on the CRT only:

```
SELECT LIST 215, LIST 005
```

4.6. DESELECTING THE MODEL DW/22-20

Use one of the following methods to deselect the printer:

1. Select another device for PRINT, LIST, or CO by using the SELECT statement.
2. Master initialize (turn system power switch off, then on). Master Initialization selects the CRT for all LIST, PRINT, and CO operations.
3. Enter CLEAR and press the RETURN (EXECUTE) key. PRINT and LIST operations are returned to the device currently selected for Console Output (CO). If the printer is currently the CO device, use either Step 1 or 2 to deselect it.
4. Turn off the SELECT lamp. This is the only method of deselection which does not lose the data in the printer buffer. Use this method when temporary deselection is required to change the paper or ribbon cartridge.
5. Encode PRINT HEX(02070F) in a BASIC program. This command code may be sent to the printer anytime. The printer's SELECT indicator lamp will go out, and you can reselect the printer only from the printer keyboard.

Example:

```
:100 PRINT "PLEASE CHANGE THE PREPRINTED FORM AND PRESS 'SELECT'"  
:110 PRINT HEX(02070F)
```

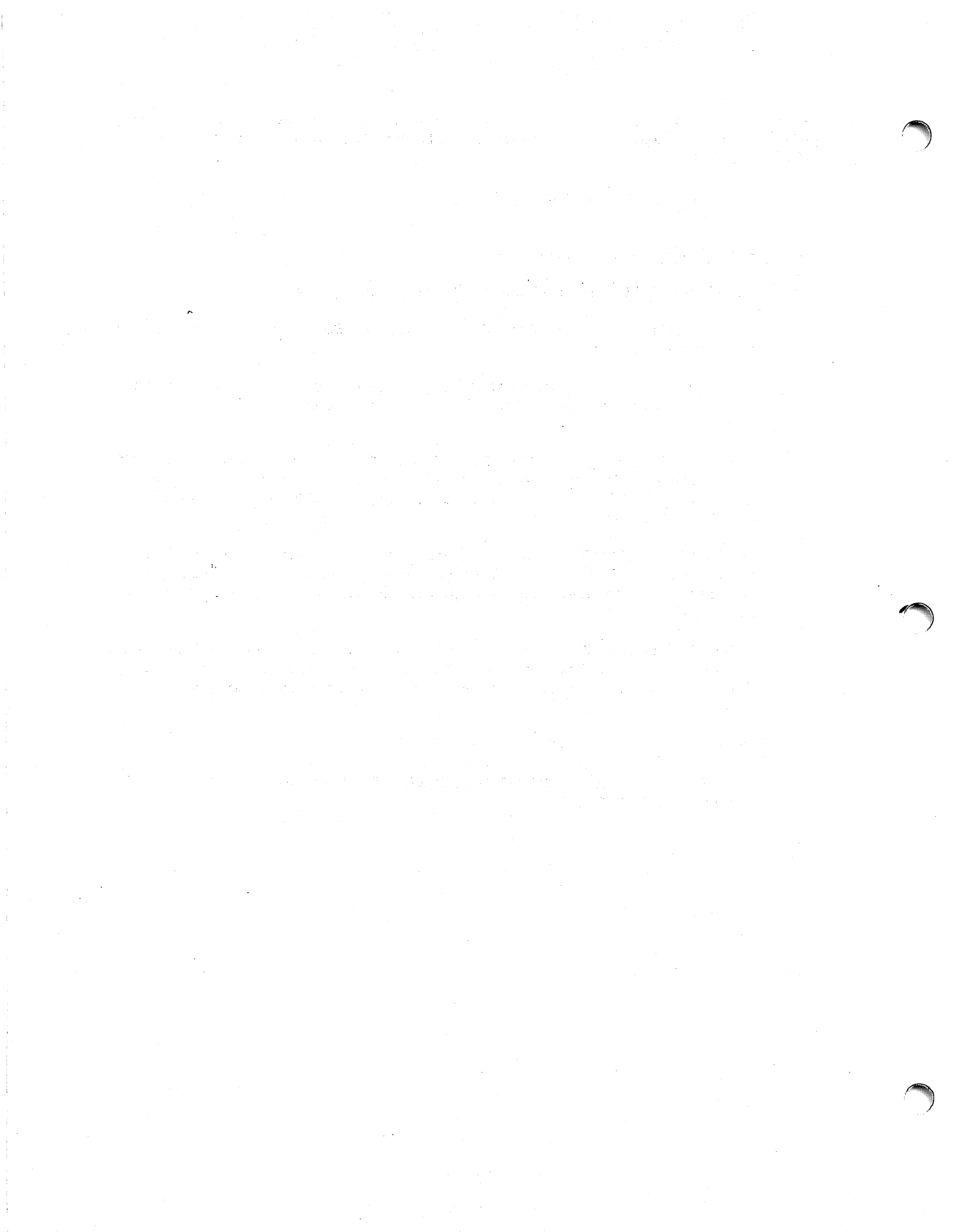

CHAPTER 5
FORMATTING OUTPUT WITH THE PRINT STATEMENT

5.1 PRINT, PRINTUSING, AND HEXPRINT STATEMENTS

The PRINT, PRINTUSING, and HEXPRINT statements are used with the Model DW/22-20 in the same manner as the CRT, although more 16-character print zones are available on the printer.

When 10-pitch is selected, the Model DW/22-20 has a line length of 132 characters, divided into 8 zones of 16 characters each and 1 zone of 4 characters. The zones constitute columns 0-15, 16-31, 32-47, 48-63, 64-79, 80-95, 96-111, 112-127, and 128-132, respectively.

When 12-pitch is selected, the Model DW/22-20 has a line length of 158 characters, divided into 9 zones of 16 characters each and 1 zone of 14 characters. The zones constitute columns 0-15, 16-31, 32-47, 48-63, 64-79, 80-95, 96-111, 112-127, 128-143, and 144-158, respectively.

Zone Format

If commas separate elements in a PRINT statement, then each element begins at the start of a new zone. When the system encounters a comma preceding a print element, it outputs spaces until it reaches the first character position of the next zone. It then outputs the value of the print element starting at that position.

Example 1: PRINTING IN ZONED FORMAT WITH COMMAS

```
:20 SELECT PRINT 215 (132)
:30 PRINT "COLUMNS 0-15", "COLUMNS 16-31", "COLUMNS 32-47"
:RUN (EXEC)
```

Output:

```
          COLUMNS 0-15          COLUMNS 16-31          COLUMNS 32-47
```

Example 2: SKIPPING OVER ZONES WITH COMMAS

```
:20 SELECT PRINT 215 (158)
:30 PRINT "ACCOUNT NO.",,,, "BALANCE DUE"
:40 PRINT "(COLUMNS 0-15)",,,, "(COLUMNS 48-63)"
:50 PRINT 10082,,,,153.19
:RUN (EXEC)
```

Output:

ACCOUNT NO.
(COLUMNS 0-15)
10082

BALANCE DUE
(COLUMNS 48-63)
153.19

NOTE

In zone printing on the Model DW/22-20, it is important to make sure that information supplied to the last zone does not exceed the legal length of the last zone (either 4 or 13 characters long depending on pitch selection). For instance, in a 10-pitch format, if the information for the last zone exceeds 4 columns, then the information is printed in the first zone of the next line.

Example:

```
:10 SELECT PRINT 215 (124)
:20 PRINT "NO.",1.2,3.4,5.6,7.8,9.0,8.4,10.2, 7.5,
2.2, 4.4, "BALANCE DUE NOW"
```

Output:(compressed)

```
NO. 1.2 3.4 5.6 7.8 9.0 8.4 10.2 7.5 2.2
4.4
BALANCE DUE NOW
```

In the previous example, the twelfth element in Line 20 exceeded four characters in length and thus was printed in the next line.

Packed Format

If semicolons separate elements in a PRINT statement, the output appears in a packed format with no spaces between items. In packed format, no additional blanks are added to the print line; blanks in the print line occur only when they are an explicit part of an alpha value or according to the rules for numeric values.

Example 1:

```
:SELECT PRINT 215
:10 A=1234 : B = -5678
:20 PRINT "ABC" ; "DEF"
:30 PRINT A;B
:RUN (EXEC)
```

Output:

```
ABCDEF
1234 -5678
```

Example 2:

```
:20 SELECT PRINT 215 (132): DIM A$18
:30 A$= "4-BEDROOM SALT BOX": P$= "$53,000"
:40 PRINT "STYLE: "; A$; " PRICE: "; P$
:RUN (EXEC)
```

Output:

```
STYLE:4-BEDROOM SALT BOX PRICE $53,000
```

NOTE

A semicolon at the end of a PRINT statement suppresses the normal line feed at execution.

Example:

```
:10 SELECT PRINT 215
:20 PRINT "FAR-";
:30 PRINT "OFF"
:RUN (EXEC)
```

Output:

```
FAR-OFF
```

Example 3: FORMATTING WITH PRINT USING STATEMENT

```
:20 SELECT PRINT 215 (180): DIM A$ 18
:30 A$= "4-BEDROOM SALT BOX": P=53000
:40 PRINT USING 50, A$,P
:50 % STYLE ##### PRICE-###,###
:RUN (EXEC)
```

Output:

```
STYLE 4-BEDROOM SALT BOX PRICE-$53,000
```

Example 4: PRINTING WITH HEXPRINT STATEMENT

```
:20 SELECT PRINT 215 (157)
:30 A$="ABC DEF GHI JKL"
:40 HEXPRINT A$
:RUN (EXEC)
```

Output:

4142432044454620474849204A4B4C20

PRINTUSING Statement

The PRINTUSING statement can be used to specify the print format to print columns of information across a line, or to print numeric and/or alphanumeric values according to an exact image. For a complete discussion of the PRINTUSING statement, refer to the Wang BASIC Language Reference Manual applicable to the system's CPU.

Example 1:

```
:10 X=1: Y=2: Z=3
:20 PRINTUSING 30, X; Y; Z
:30 % #.#
:RUN (EXEC)
```

Output:

1.0 2.0 3.0

Example 2:

```
:100 PRINTUSING 200
:200 % PROFIT AND LOSS STATEMENT
:RUN (EXEC)
```

Output:

PROFIT AND LOSS STATEMENT

Example 3:

```
:50 A$="J. SMITH": T=923751
:100 PRINTUSING 200, A$, T
:200 % SALESMAN ##### TOTAL SALES $$$,###.##
:RUN (EXEC)
```

Output:

SALESMAN J. SMITH TOTAL SALES \$9,237.51

Example 4:

```
:10 X=2.3: Y=27.123
:20 PRINTUSING 30, X, Y
:30 % ANGLE -##### LENGTH=+###.#
:RUN (EXEC)
```

Output:

ANGLE 2.300000 LENGTH=+27.1

5.2 The PRINT TAB(); FUNCTION

The PRINT TAB(); function can be used to position the print location prior to typing a character. When a PRINT statement containing a TAB function is executed, the printer skips to the column specified by the integer portion (in parentheses) of the TAB(); expression, and then prints the indicated argument.

Example 1:

```
:SELECT PRINT 215(157)
:10 PRINT TAB(75);"MASTER SEWERAGE PLAN"
:20 PRINT: PRINT
:30 PRINT TAB(40);"STREET";TAB(70);"LINE FEET";
    TAB(110);"PIPE DIA.";TAB(130);"CONNECTIONS"
:RUN (EXEC)
```

Output:

```
MASTER SEWERAGE PLAN

STREET          LINE FEET          PIPE DIA.          CONNECTIONS
```

In the above example, MASTER SEWERAGE PLAN is printed starting at Column 75; likewise, the headings in Line 30 are printed at the specified tab settings.

If the value of the TAB(); expression is greater than the selected line length, the printer moves to the next line and completes the PRINT statement starting at Column 0.

Example 2:

```
:10 SELECT PRINT 215
:20 A=25
:30 PRINT TAB(A);"TANK MODEL";TAB(3*A);"CREW SIZE"
RUN (EXEC)
```

Output:

```
TANK MODEL

CREW SIZE
```

NOTE

If the carriage position in the line being printed is greater than the TAB(); argument, the tab is ignored. For example, in the following statement the TAB(5); is ignored.

```
10 PRINT "123456789"; TAB(5); "No."
```

When using the TAB function to print numeric values in columnar format, an additional column (to the left of the value) is allocated for the sign (+ or -). If it is not used (for positive numbers), actual printing begins at the column specified, plus one.

Example 3:

```
:10 SELECT PRINT 215 (80)
:20 PRINT TAB(10);"POWER";TAB(20);"VALUE"
:30 FOR N=-1 TO 10
:40 PRINT TAB(10);N;TAB(20);(-2)|N
:50 NEXT N
:RUN (EXEC)
```

Output:

POWER	VALUE
-1	-.5
0	1
1	-2
2	4
3	-8
4	16
5	-32
6	64
7	-128
8	256
9	-512
10	1024

CHAPTER 6
FORMATTING OUTPUT WITH HEX CODES

6.1 THE HEX FUNCTION

The HEX function is used in a BASIC program to output characters on the printer (both those that do and do not appear on the standard keyboards) or to execute special printer control codes. The HEX function has the following form:

```
HEX(hh [hh] [..] .)
```

Each h equals a hex digit, 0 to 9, or a letter, A to F. An even number of characters must always appear in a HEX function; spaces are not allowed. (Refer to Appendix A for a complete listing of hexadecimal character codes and control codes.)

Hex codes for characters and/or printer control can be combined. For example, the following program in memory:

```
:10 SELECT PRINT 215  
:20 PRINT HEX (410D0A42)  
:RUN (EXEC)
```

produces: A

B

when run, since the code for 'A' is HEX(41), 'carriage return' is HEX(0D), 'line feed' is HEX(0A), and 'B' is HEX(42).

6.2 MODEL DW/22-20 CONTROL CODES

When the Model DW/22-20 receives a hex code for a printable character, it simply places the code into its print buffer. No immediate action is taken unless the buffer is full. However, certain special hex codes do not enter the buffer; instead these codes can cause immediate action by the printer. These special codes are the printer control codes.

Several features of the DW/22-20 printer are similar to features found on the 2236DE terminal. These features and some others have been defined in terms of code sequences beginning with HEX(02). These code sequences control platen clearing, the setting of form length, underscoring, the setting of line feed size, the suppression of automatic line feed, power-on reset, and the selection of front or rear paper bin feeding on the optional Twin Sheet Feeder.

Automatic Line Feed Suppression

The automatic line feed which normally follows a carriage return [HEX(0D)] at the end of a print line can be suppressed by executing the following command code sequence:

```
HEX(020A0F)
```

The Automatic Line Feed Suppression control code sequence may be combined with a line feed spacing change (refer to the Set Line Feed Spacing section in this chapter and Table 6-3) by executing the following command code sequence:

```
HEX(020A0102YZZOF)
```

After execution of either of these control code sequences, the automatic line feed feature remains off until one of the following conditions occurs:

1. The printer receives a control code sequence to restart automatic line feed, i.e., HEX(020A0E).
2. The operator changes the line feed spacing increment with a control code sequence ending in HEX(0E), i.e., HEX(020A0102YZZOE). (Refer to the Set Line Feed Spacing section in this chapter and Table 6-3.)
3. The printer receives a Power-On Reset control code sequence, i.e., HEX(020D0C03OF).
4. The operator turns the printer off and then on.

Backspace HEX(08)

The Backspace code causes the internal line buffer pointer to be decremented by one character. Characters entered prior to the Backspace code(s) can be underscored (using HEX(5F)). Non-space characters will not be overwritten, but previous spaces can be filled in with new characters.

Example 1:

```
:100 PRINT "REPORT #113 - CHEMICAL  
      ANALYSIS";  
:110 HEX(0808080808080808080808080808080808);  
:120 HEX(5F5F5F5F5F5F5F5F5F5F5F5F5F5F5F5F5F)
```

Output:

REPORT #113 - CHEMICAL ANALYSIS

Example 2:

```
:100 PRINT "NAME ="; HEX(080808080808); "XXX"
```

Output:

NAME =

Example 3:

```
:100 PRINT "TABLE#           IS FULL";  
:110 PRINT HEX(08080808080808080808080808080808);"N13046-52"
```

Output:

TABLE# N13046-52 IS FULL

Carriage Return HEX(0D)

The Carriage Return code prints the current contents of the line buffer and advances the paper one line.

Example:

```
:10 PRINT "SPARE PARTS LIST"  
:20 PRINT HEX(0D0D0D)  
:30 PRINT "ITEM","QUANTITY"
```

Output:

```
SPARE PARTS LIST  
  
ITEM           QUANTITY
```

Select HEX(02070E)

The Select command allows you to select a deselected printer under software control. This command causes the SELECT indicator lamp to light. The printer can then be deselected only from the printer keyboard.

Example:

```
:100 PRINT " PLEASE CHANGE RIBBON AND PRESS 'SELECT'"  
:110 PRINT HEX(02070E)
```

Deselect HEX(02070F)

The Deselect command allows you to deselect the printer under software control to facilitate such operations as a forms change or a daisy wheel replacement. This command causes the SELECT indicator lamp to light. The printer can then be reselected only from the printer keyboard.

Example:

```
:100 PRINT "PLEASE CHANGE DAISY WHEEL AND PRESS 'SELECT'"
:110 PRINT HEX(02070F)
```

Line Feed HEX(0A)

The Line Feed command causes the current contents of the line buffer to be printed and advances the paper one line.

Example:

```
:10 PRINT "WATCH";
:20 PRINT HEX(0A);"YOUR";
:30 PRINT HEX(0A);"STEP"
```

Output:

```
WATCH
      YOUR
          STEP
```

Move (Absolute) HEX(E7XXXXYYYY)

The Move (Absolute) command moves the carriage to the desired absolute X and Y position on a form (relative to the current home) after printing the current data in the buffer. This command allows the carriage to be repositioned to a specified location from the home reference position with an accuracy of 1/60 inch X and 1/48 inch Y. XXXX and YYYY (2's complement hexadecimal format) are the number of horizontal (1/60 inch) and vertical (1/48 inch) increments from home. (Refer to Appendix C for converting distance to 2's complement hexadecimal format.)

NOTE

The YYYY values for vertical movements in the HEX(E7) command cause the platen to move as follows:

A positive YYYY moves down on the form (paper out).

A negative YYYY moves up on the form (paper in).

Example 1:

```
:SELECT PRINT 215
:10 PRINT HEX(E7003C0060);
```

Result 1:

Moves 1 inch to the right and
2 inches down from the current
home position

Example 2:

```
:10 SELECT PRINT 215
:20 PRINT HEX(E70000FDC0);
```

Result 2:

Moves 12 inches up from the
current home position

Table 6-1 provides a convenient conversion of physical distance to hexadecimal values for vertical movement (YYYY). You can use Table 6-2 for the XXXX values in the HEX(E7XXXXYYYY) code.

Table 6-1. Conversion of Physical Distance to Hexadecimal Values Based on 1/48 Inch Increments

Vertical Distance <u>Down</u> From Home Position (Inches)	YYYY Value In HEX(E7XXXXYYYY)	Vertical Distance <u>Up</u> From Home Position (Inches)	YYYY Value In HEX(E7XXXXYYYY)
1	0030	-1	FFD0
2	0060	-2	FFA0
3	0090	-3	FF70
4	00C0	-4	FF40
5	00F0	-5	FF10
6	0120	-6	FEE0
7	0150	-7	FEB0
8	0180	-8	FE80
9	01B0	-9	FE50
10	01E0	-10	FE20*
11	0210	-11	FDF0
12	0240	-12	FDC0

*Refer to Appendix D.

The YYYY values shown in Table 6-1 are derived using the procedures discussed in Appendix C and illustrated in the following example:

Determine the hexadecimal value (in 2's complement format) for a vertical movement of -6 inches.

Step 1: Find the number of 1/48 inch increments in 6 inches.

$$6 / (1/48) = 288$$

Step 2: Convert 288 into a hexadecimal number.

$$288 = \text{HEX}(0120)$$

Step 3: Find the 2's complement of HEX(0120).

```
complement HEX(0120) + 1 = complement(0000 0001 0010 0000)+1
                        = 1111 1110 1101 1111+1
                        = 1111 1110 1110 0000
                        = HEX(FEE0)
```

Example 3:

```
:10 SELECT PRINT 215
:20 A$="NAME" :B$="ADDRESS" :C$="TELEPHONE NO."
:30 PRINT HEX(E7003C0000); A$
:40 PRINT HEX(E700B40000); B$
:50 PRINT HEX(E7012C0000); C$
:60 PRINT HEX(E700B4FFD0); "CLASS LISTING"
:RUN (EXEC)
```

Output:

CLASS LISTING

NAME	ADDRESS	TELEPHONE NO.
------	---------	---------------

Power-On Reset HEX(020DOC030F)

The Power-On Reset control code moves the print wheel to the power-on position at the left end of the carriage. In addition, the printer executes a form feed if and only if it is not already at the top of form. The home position and left margin position are automatically redefined at the absolute left margin position, and the line feed size defaults to 6 lines/inch; all preset tabs are cleared, and the printer assumes the default font. You can use this command to reinitialize the programmable formatting features of the Model DW/22-20 without powering down the printer. It is useful when changing from one form to another. In this case, it should be one of the last commands issued by the program controlling the first form.

Processing Continuous Forms

When using the Model DW/22-20 to process continuous forms, there are two ways of moving to the start of the next form. The Top of Form hex code [HEX(0C)] is the most common method. For example:

```
:900 PRINT HEX(0C);
```

If the form length is other than 11 inches, you can use the following procedure involving the Move (Absolute) command (HEX(E7XXXXYYYY)) and the Set Home command (HEX(E4)):

1. Convert the form length from inches to vertical increments of 1/48 inch (Table 6-1). This constant value (VVV) will be used in Step 3.
2. Manually set a home position on the first form.
3. When the first form has been completed, the carriage and the platen can be moved to the identical position on the next form, and a new home position may be set there by using a combination of the Move (Absolute) command and the Set Home command as follows:

```
:900 PRINT HEX(E70000VVVE4);
```

Reverse Index HEX(FA)

The Reverse Index command moves the platen backwards, one line at a time, with the line spacing interval specified by the Set Line Feed Spacing command HEX(020A0102YYZZ0E).

Example:

```
:10 SELECT PRINT 215  
:20 PRINT HEX(020A010230000E);  
:30 PRINT HEX(FA);
```

Output:

Moves the platen backwards one line. The line spacing interval is one line per inch.

Set Form Length HEX(020C0102YYYY0F)

Most standard forms are 11 inches in length. At times it may be necessary to use shorter or longer forms, for example, 14-inch legal paper. The printer has been provided with a control code sequence that allows a program to dynamically set the form length to another value, and accordingly change the lines per page (lines per inch x form length). That control sequence is HEX(020C0102YYYY0F), wherein the character string YYYY is a positive hexadecimal value representing the desired form length in increments of 1/48 inch. If not at top of page, this sequence first generates a top of form (HEX(0C)) before setting the new form length size. *

Once set, the form length remains set until one of the following conditions occurs:

1. The operator executes another Set Form Length control code sequence [HEX(020C0102YYYY0F)].
2. The form length is reset to 11 inches by the execution of a Power-On Reset control code sequence [HEX(020D0C030F)].

3. The operator turns the printer off and then on.

NOTE

Setting the form length has no effect on vertical format size. The vertical format remains set at 6 lines, based on 6 lines per inch.

Example 1:

```
:10 F$=HEX(020C010200000F)
:20 BIN(STR(F$,5,2),2)=672
:30 PRINT STR(F$,1,7);
:RUN (EXEC)
```

$STR(F$, 5, 2) = BIN(672, 2)$

Result:

Sets the form length to 14 inches. (Note that 14 inches equals 672 increments of 1/48 inch.)

Example 2:

```
:10 F$=HEX(020C010200000F)
:20 BIN(STR(F$,5,2),2)=528
:30 PRINT STR(F$,1,7);
:RUN (EXEC)
```

$STR(F$, 5, 2) = BIN(528, 2)$

Result:

Sets the form length to 11 inches. (Note that 11 inches equals 528 increments of 1/48 inch.)

Set Home HEX(E4)

Under program control, this code duplicates the function of setting the home position (X=0, Y=0). The Set Home command defines the current carriage position as the home position.

Example:

```
:100 PRINT HEX(E4);
```

Set Left Margin HEX(E8XXXX)

The Set Left Margin control code allows you to select a left margin location which is an integer multiple of 1/60 inch. The left margin distance is specified from the current home position. Following the definition of a new left margin, all BASIC output will be justified relative to the new margin specified. XXXX equals the margin specification (2's complement hexadecimal format) representing the number of 1/60 inch increments from the current home position. (Refer to Appendix C for converting distance to 2's complement hexadecimal format.)

The left margin is reset to its default value (the extreme left margin) under the following conditions:

1. The printer is powered on.
2. A Power-On Reset command sequence [HEX(02000C030F)] is executed.

Example 1: Result 1:

```

:10 SELECT PRINT 215      This program sets the left margin at
:20 PRINT HEX(E80078);    a point 2 inches to the right of the
:30 PRINT " LEFT MARGIN"  current home position and prints LEFT
                          MARGIN starting at that point.

```

Example 2: Result 2:

```

:10 SELECT PRINT 215      This program sets the left margin at
:20 PRINT HEX(E8FFC4);    a point 1 inch to the left of the
                          current home position.

```

Note in these examples the use of the semicolon at the end of the PRINT statement to suppress line feed.

Table 6-2 provides a convenient conversion of physical distance to hexadecimal values for use with the Set Left Margin control code.

Table 6-2. Conversion of Physical Distance to Hexadecimal Values Based on 1/60 Inch Increments

Left Margin Distance From Current Home (Inches)	XXXX Value In HEX(E8XXXX)	Left Margin Distance From Current Home (Inches)	XXXX Value In HEX(E8XXXX)
0	0000		
1	003C	-1	FFC4
2	0078	-2	FF88
3	00B4	-3	FF4C
4	00F0	-4	FF10
5	012C	-5	FED4
6	0168	-6	FE98
7	01A4	-7	FE5C
8	01E0	-8	FE20*
9	021C	-9	FDE4
10	0258	-10	FDA8
11	0294	-11	FD6C
12	02D0	-12	FD30

*Refer to Appendix D.

The XXXX values shown in Table 6-2 are derived using the procedures discussed in Appendix F and illustrated in the following example:

Determine the hexadecimal value (in 2's complement format) for a left margin of -6 inches.

Step 1: Find the number of 1/60 increments in 6 inches.

$$6 / (1/60) = 360$$

Step 2: Convert 360 into a hexadecimal number.

$$360 = \text{HEX}(0168)$$

Step 3: Find the 2's complement of HEX(0168).

$$\begin{aligned} \text{complement } \text{HEX}(0168) + 1 &= \text{complement } (0000\ 0001\ 0110\ 1000) + 1 \\ &= 1111\ 1110\ 1001\ 0111 + 1 \\ &= 1111\ 1110\ 1001\ 1000 \\ &= \text{HEX}(\text{FE98}) \end{aligned}$$

Example 3:

```
:400 REM SET LEFT MARGIN TO 4
      INCHES AND LINE FEED
      SIZE TO 3.5 LINES/IN.
:410 PRINT HEX (E800F0E90DBF);
:420 REM OUTPUT COLUMN DATA
:430 FOR I = 1 TO 15
:440 PRINTUSING 460, A(I), B(I)
:450 NEXT I
:460 %$#,###.##
:470 REM RESET LEFT MARGIN TO
      ZERO AND LINE FEED SIZE TO
      6 LINES/INCH
:480 PRINT HEX (E80000E90800);
```

Result 3:

A set of 15 items is printed (in the PRINTUSING format of line 460) in two columns positioned 15 character spaces apart (zone format). The first column is set 4 inches to the right of the home position. The items are printed at 3.5 lines per inch.

Set Line Feed Spacing HEX(E9YYFF)

The Set Line Feed Spacing code allows program selection of any line feed spacing which is a multiple of 1/48 inch. This allows you to specify nonstandard line spacings. YYFF defines the line feed spacing (see Table 6-3). The first byte (YY) equals an integer multiple of 1/48 inch, and the second byte (FF) equals a fractional part of the 1/48 inch step increment (1/256 increment). If a fractional part (FF) of an increment is specified, the printer always rounds off each line feed to the nearest whole increment (1/48). It also maintains an error correction factor which minimizes the positional offset at the end of long forms. Note that line feed spacing is always positive.

The line feed spacing is reset to the default value of 6 lines per inch under any one of the following conditions:

1. The printer is powered ON.
2. The current line feed spacing command is cleared from memory.

NOTE

Setting a new line feed size should have no affect on the current form feed size if you adhere to the following rules:

1. Set Line Feed Spacing after the printer is powered off and then on.
2. Set Line Feed Spacing after execution of a Power-On Reset sequence.
3. Set Line Feed Spacing after execution of a Form Feed code.



Set Line Feed Spacing HEX(020A0102YYZZ0E) or HEX(020A0102YYZZ0F)

? \checkmark (E944FF)

The command sequence to set line feed spacing allows program selection of any line feed spacing which is a multiple of 1/48 inch. This allows the user to specify nonstandard line spacings. YZZZ defines the line feed spacing. The first byte (YY) equals an integer multiple of 1/48 inch, and the second byte (ZZ) equals a fractional part of the 1/48 inch step increment (1/256 increment). If a fractional part (ZZ) of an increment is specified, the printer always rounds off each line feed to the nearest whole increment (1/48). It also maintains an error correction factor which minimizes the positional offset at the end of long forms. Note that line feed spacing is always positive.

The line feed spacing is reset to the default value of 6 lines per inch under any one of the following conditions:

1. The printer is powered on.
2. The current line feed spacing command is cleared from memory.
3. A HEX(020D0C030F) reset sequence is executed.

Refer to the section on Automatic Line Feed Suppression in this chapter for instructions on how to combine a line feed spacing change with a suppression of automatic line feed.

The YZZZ values shown in Table 6-3 are derived using the procedures discussed in Appendix C and illustrated in the following example:

Determine the hexadecimal value for a line spacing of 0.4 inches or 2.5 lines/inch.

Step 1: Find the number of 1/48 inch increments in 0.4 inches.

$$(0.4) \div (1/48) = 19.2$$

Step 2: Convert 19 into its hexadecimal value.

$$19 = \text{HEX}(13)$$

Step 3: Find the number of 1/256 inch increments in 0.2.

$$(0.2) \div (1/256) = 51.2 = 51 \text{ (rounded off)}$$

Step 4: Convert 51 into its hexadecimal value.

$$51 = \text{HEX}(33)$$

Step 5: Combine the hexadecimal values obtained in Steps 2 and 4.

$$\text{HEX}(13) \text{ and } \text{HEX}(33) = \text{HEX}(1333)$$

Example 1:

```
:100 PRINT HEX(020A010210000E);
```

Result 1:

This statement sets the line feed size at an even 16 increments/line, or 3 lines/inch.

Example 2:

```
:100 PRINT HEX(020A0102099A0E);
```

Result 2:

This statement sets the line feed size at 9.6 increments, or 5 lines/inch.

Example 3:

```
:90 REM QUARTER LINE FEED
:100 PRINT HEX(020A010202000E);
" 2 2 2"
:110 PRINT HEX(020A010202000E);
"a + b = r"
```

Result 3:

$$a^2 + b^2 = r^2$$

Example 4:

```
:5 REM QUARTER LINE FEED
:10 PRINT HEX(020A010202000E);
"a + b = r"
:20 PRINT HEX(020A010202000E);
" x y"
```

Result 4:

$$a_x + b_y = r$$

Table 6-3. Conversion of Physical Lines Per Inch Values to Hexadecimal Form

?

Line Feed Spacing in Lines/Inches	Increments Between Lines		YYZZ (in HEX(E9YYZZ))
	1/48 Inch Increments	1/256 Inch Increments	
1	48	0	3000
1.5	32	0	2000
2	24	0	1800
2.5	19.2	51	1333
3	16	0	1000
3.5	13.714	183	0DB7
4	12	0	0C00
4.5	10.606	170	0AAA
5	9.6	154	099A
5.5	8.727	186	08BA
6 (default value)	8	0	0800
6.5	7.38	98	0762
7	6.857	219	06DA
7.5	6.4	102	0666
8	6	0	0600
8.5	5.647	166	05A6
9	5.33	85	0555
9.5	5.05	13	050D*
10	4.8	205	04CD
11	4.364	94	045E
12	4	0	0400
13	3.692	177	03B1
14	3.429	110	036E
15	3.2	51	0333
16	3	0	0300
17	2.824	211	02DE
18	2.667	171	02AB
19	2.526	135	0287
20	2.4	102	0266
21	2.286	73	0249
22	2.182	47	022F
23	2.087	22	0216
24 (quarter line)	2	0	0200

* Refer to Appendix D.

Example 5:

Result 5:

```
:10 SELECT PRINT 215
:15 REM 1 LINE PER IN.
:20 PRINT HEX(020A010230000E);
:30 FOR A = 1 TO 2
:40 PRINT "AAAAAAA"
:50 NEXT A

:55 REM 2 LINES/INCH
:60 PRINT HEX(020A02018000E);
:70 FOR B = 1 TO 3
:80 PRINT "BBBBBBB"
:90 NEXT B

:95 REM 3 LINES/INCH
:100 PRINT HEX(020A010210000E);
:110 FOR C = 1 TO 4
:120 PRINT "CCCCCCC"
:130 NEXT C

:135 REM 4 LINES PER IN.
:140 PRINT HEX(020A01020C000E);
:150 FOR D = 1 TO 5
:160 PRINT "DDDDDDD"
:170 NEXT D

:175 REM 5 LINES PER IN.
:180 PRINT HEX(020A0102099A0E);
:190 FOR E = 1 TO 6
:200 PRINT "EEEEEEE"
:210 NEXT E

:215 REM 6 LINES PER IN.
:220 PRINT HEX(020A010208000E);
:230 FOR F = 1 TO 6
:240 PRINT "FFFFFFF"
:250 NEXT F
```

AAAAAAA
AAAAAAA
BBBBBBB
BBBBBBB
BBBBBBB
CCCCCCC
CCCCCCC
CCCCCCC
CCCCCCC
DDDDDDD
DDDDDDD
DDDDDDD
DDDDDDD
DDDDDDD
EEEEEEE
EEEEEEE
EEEEEEE
EEEEEEE
EEEEEEE
FFFFFFF
FFFFFFF
FFFFFFF
FFFFFFF
FFFFFFF
FFFFFFF

Example 5: (continued)

Result 5: (continued)

```
:255 REM 7 LINES PER IN.      GGGGGGG
:260 PRINT HEX(020A010206DA0E); GGGGGGG
:270 FOR G = 1 TO 7           GGGGGGG
:280 PRINT "GGGGGGG"         GGGGGGG
:290 NEXT G                   GGGGGGG
                               GGGGGGG
```

```
:295 REM 8 LINES PER IN.     HHHHHHH
:300 PRINT HEX(020A010206000E); HHHHHHH
:310 FOR H = 1 TO 8          HHHHHHH
:320 PRINT "HHHHHHH"        HHHHHHH
:330 NEXT H                   HHHHHHH
                               HHHHHHH
```

```
:335 REM 9 LINES PER IN.     IIIIIII
:340 PRINT HEX(020A010205550E); IIIIIII
:350 FOR I = 1 TO 9          IIIIIII
:360 PRINT "IIIIIII"        IIIIIII
:370 NEXT I                   IIIIIII
                               IIIIIII
```

```
:375 REM 10 LINES PER IN.    JJJJJJJ
:380 PRINT HEX(020A010204CD0E); JJJJJJJ
:390 FOR J = 1 TO 10         JJJJJJJ
:400 PRINT "JJJJJJJ"        JJJJJJJ
:410 NEXT J                   JJJJJJJ
                               JJJJJJJ
```

Top of Form HEX(0C)

This command advances the paper to the top of the next form (11-inch form assumed) or to the first position setting in channel one of the DAVFU.

Example:

```
:10 PRINT "LIST OF DONORS"
.
.
.
:250 PRINT "THIS CONCLUDES THE
      LIST OF DONORS"
:260 REM START NEW LISTING
:270 PRINT HEX(0C);
```

Underscore

There are several ways in which characters can be underscored on the DW/22-20 printer. The first is to backspace [HEX(08)] over previously printed characters and then use the Underscore code, HEX(5F). The HEX(5F) code places an underscore in the line buffer at the current location of the internal line buffer pointer.

Example 1:

```
:10 PRINT "NO SMOKING PLEASE";
:20 PRINT HEX(080808080808);
:30 PRINT HEX(5F5F5F5F5F5F)
:RUN (EXEC)
NO SMOKING PLEASE
```

Note that since the Underscore code does not begin with a zero hex digit, the 2200's internal line count is incremented as each underscore is executed. If underscoring is to be done near the end of the print line, it is advisable to select a line length greater than 132 (10-pitch) or 157 (12-pitch) to prevent an unwanted carriage return from being executed by the 2200 CPU.

Example 2:

```
:10 SELECT PRINT 215(255)
:20 PRINT TAB (170); "AB";
:30 PRINT HEX(08085F5F)
```

The DW/22-20 also provides the ability to underscore printed output using the HEX(0E) and HEX(0F) codes. HEX(0E) and HEX(0F) are usually treated as null codes. They can be redefined to produce underscoring by either of the two command sequences described below.

The HEX(02040004000E) sequence immediately turns on the underscore and leaves it on until an isolated HEX(0F) or the code sequence, HEX(02040000000E), occurs. The latter sequence, in addition to turning off the underscore feature, redefines HEX(0E) and HEX(0F) as null codes.

Example 3:

```
:10 PRINT HEX(02040004000E);
:20 PRINT "THE LAZY DUCK"
:30 PRINT "JUMPS OVER THE"
:40 PRINT HEX(0F); "QUICK BLACK DOG."
:RUN (EXEC)
THE LAZY DUCK
JUMPS OVER THE
QUICK BLACK DOG
```

The HEX(02040004000F) sequence defines an isolated HEX(0E) code to turn on the underscore. Either a carriage return, the carriage return control code [HEX(0D)], or an isolated HEX(0F) then turns off the underscore. This underscore feature allows the printer to highlight printed output in the same way other Wang printers use expanded print. That is, the occurrence of a HEX(0E) anywhere in a print line causes the entire line to be underscored. Subsequent lines will not be underscored unless they too contain a HEX(0E).

Example 4:

```
:10 PRINT HEX(02040004000F);
:20 PRINT "A FULLY GROWN KOALA"
:30 PRINT "WEIGHS ON THE AVERAGE";HEX(0E)
:40 PRINT "ABOUT NINE KILOGRAMS."
:RUN (EXEC)
A FULLY GROWN KOALA
WEIGHS ON THE AVERAGE
ABOUT NINE KILOGRAMS.
```

Vertical Tab HEX(0B)

The Vertical Tab (HEX(0B)) causes a vertical paper movement of 6 lines with: spacing dependent on the current line feed size. On power-on, the printer defaults to 6 lines per inch (LPI) and an 11-inch form (66 lines). You can only change LPI after the power-on sequence or after setting a top of form. A change of 8 LPI at the top of the form changes the 11-inch form to 88 lines long, yet leave the length (11 inches) the same.

When the HE(0B) code is embedded within a line of printable data, it causes the data currently in the buffer to be printed before advancing to the next vertical tab.

NOTE

If the form length is not an integral value, HEX(0B) causes the paper to advance to top-of-form after the last tab location. For example, if the form length is 13.5 inches, after the 13th tab the paper advances to the top of the next form. If a DAVFU is downloaded without setting tabs in channel 2, a Vertical Tab (HEX(0B)) functions like a Top of Form (HEX(0C)).

Select Character Font HEX(0202aa0F)

The DW/22-20 contains three fonts. Font 0 is the standard ASCII characters font; Font 1 is the alternate font; Font 2 is the second alternate font.

When the printer is powered on, or when a Power-On Reset sequence [HEX(020D0C030F)] is executed, the font selected is Font 0. The fonts can be selected by using the following code sequence:

HEX(0202aa0F)

where: aa = 00 for Font 0
 02 for Font 1
 04 for Font 2

Example (select character font):

```
2  SELECT PRINT 215
5  A$ = HEX(A1A2A3A4A5A6F1F2F3F4)
10 FOR X = 0 TO 1: D = X+1
20 ON D GOSUB 50,60
30 PRINT "FONT"; X; " PRINTS "; A$: PRINT
40 NEXT X
45 END
50 PRINT HEX(0202000F): RETURN
60 PRINT HEX(0202020F): RETURN
```

Down Load Font Description

The Down Load Font Description sequence down loads character pin data from the CPU to the printer. The sequence has the following format:

HEX(02120101ff01ccddcs0E)
or HEX(02120101ccddcs0E)

where: 12 defines the sequence as "Load Font"
 ff is a one byte font position value
 cc is a byte count of the following bytes dd...cs
 dd...cs is the data block.

The specific font position is specified by "ff" and the pin data for that position is described in a single or multiple variable-length data block. The length of each data block is given by "cc", and the ccth byte ("cs") must be the checksum for that data block.

Example:

```
10 REM THE FOLLOWING ROUTINE DOWN LOADS A BLOCK OF DATA D$( ) TO THE
   PRINTER
15 REM LOAD BYTE COUNT
20 DIM C$1
25 C=LEN(D$( ))+1
30 C$=BIN(C)
35 REM DOWN LOAD BLOCK OF DATA
40 $GIO/215(4002 4012 4001 4001 4002 4001 A000 1A00 A000 1A00 A604
   4250 400E, A2$) C$;D$( ); D$( )
```

Select Pitch HEX(02090102aabb0F)

You can select the DW/22-20 for 10-pitch, 12-pitch, or 15-pitch. When the printer is powered on or when a Power-On Reset sequence is executed, 10-pitch is automatically selected. If you then select 12-pitch, the output appears as 12-pitch. The select pitch sequence has the following format:

HEX(02090102aabb0F)

where: aabb = 0A00 for 10-pitch
 0C00 for 12-pitch
 0F00 for 15-pitch
 0000 for default (i.e., 10-pitch)

Example (pitch selection):

```
5  SELECT PRINT 215
10 DIM A$35
20 A$ = "ONE GREAT CHANGE IN THE CITY'S ROLE"
30 REM SELECT FONT 0: PRINT HEX(0202000F)
40 PRINT A$
70 REM SELECT 12-PITCH: PRINT HEX(020901020C000F)
80 PRINT A$
90 REM SELECT 10-PITCH: PRINT HEX(020901020A000F)
110 PRINT A$; HEX(0F)
```

Execute Partial Line Feed HEX(020Add0F)

The Execute Partial Line Feed sequence is used to generate partial line feeds in increments of 1/4, 1/2, or 3/4 of the currently selected full line value. The sequence has the following format:

HEX(020Add0F)

where: dd = 00 for no line feed
 02 for 1/4 line feed
 04 for 1/2 line feed
 08 for 3/4 line feed

Example:

```
0010    SELECT PRINT 204
0020    PRINT "THE EQUATION FOR Z IS:"
0030    REM SUPPRESS AUTO LINE FEED
      :    PRINT HEX (020A0F)
0040    REM PRINT SUPER SCRIPTS
      :    PRINT "      2  2"
0050    REM ADVANCE ONE HALF OF A LINE
      :    PRINT HEX (020A040F)
0060    REM PRINT BASE LINE
      :    PRINT "Z = X + Y - 2*(X+Y)"
0070    REM ADVANCE ONE HALF OF A LINE
      :    PRINT HEX (020A040F)
0080    REM PRINT SUBSCRIPTS
      :    PRINT "          3"
0090    REM REACTIVATE AUTO LINE FEED
      :    PRINT HEX (020A0E)
0100    REM MOVE TO NEXT FULL LINE POSITION
      :    PRINT
0110    REM PRINT NEXT LINE
      :    PRINT "TO CONTINUE WITH THIS LINE OF THOUGHT,"
```

Output:

THE EQUATION FOR Z IS:

$$Z = X^2 + Y^2 - 2*(X+Y)$$

3

TO CONTINUE WITH THIS LINE OF THOUGHT,

APPENDIX A
PRINTER SPECIFICATIONS

Printer Size

Height 9.0 in. (22.9 cm)
Height with Forms Tractor 12.5 in. (31.7 cm)
Depth 19.5 in. (49.5 cm)
Width 25.0 in. (63.5 cm)

Approximate Net Weight

43.0 lb (19.5 kg)

Speed

20 characters per second average, bidirectional

Pitch/Line Length

10-pitch -- 132 characters
12-pitch -- 158 characters
15-pitch -- 196 characters

Paper Specifications

Minimum Width 3.5 in. (8.9 cm)
Maximum Width 15 in. (381 cm)

Paper Thickness

.027 in. (.069 cm) (5 copies, plus original)

Print Wheels

Plastic wheels only

Character Set

96 characters, plus additional characters created by overstriking

Switches

Top of Page, Select, Test, Low and High Impression

Indicators

Power, Malfunction, Change Daisy, Test,
Change Ribbon, Change Paper, Select, Low, High

Ribbon Cartridges

Carbon or fabric

Cabling

25 ft (7.6 m) printer to CPU

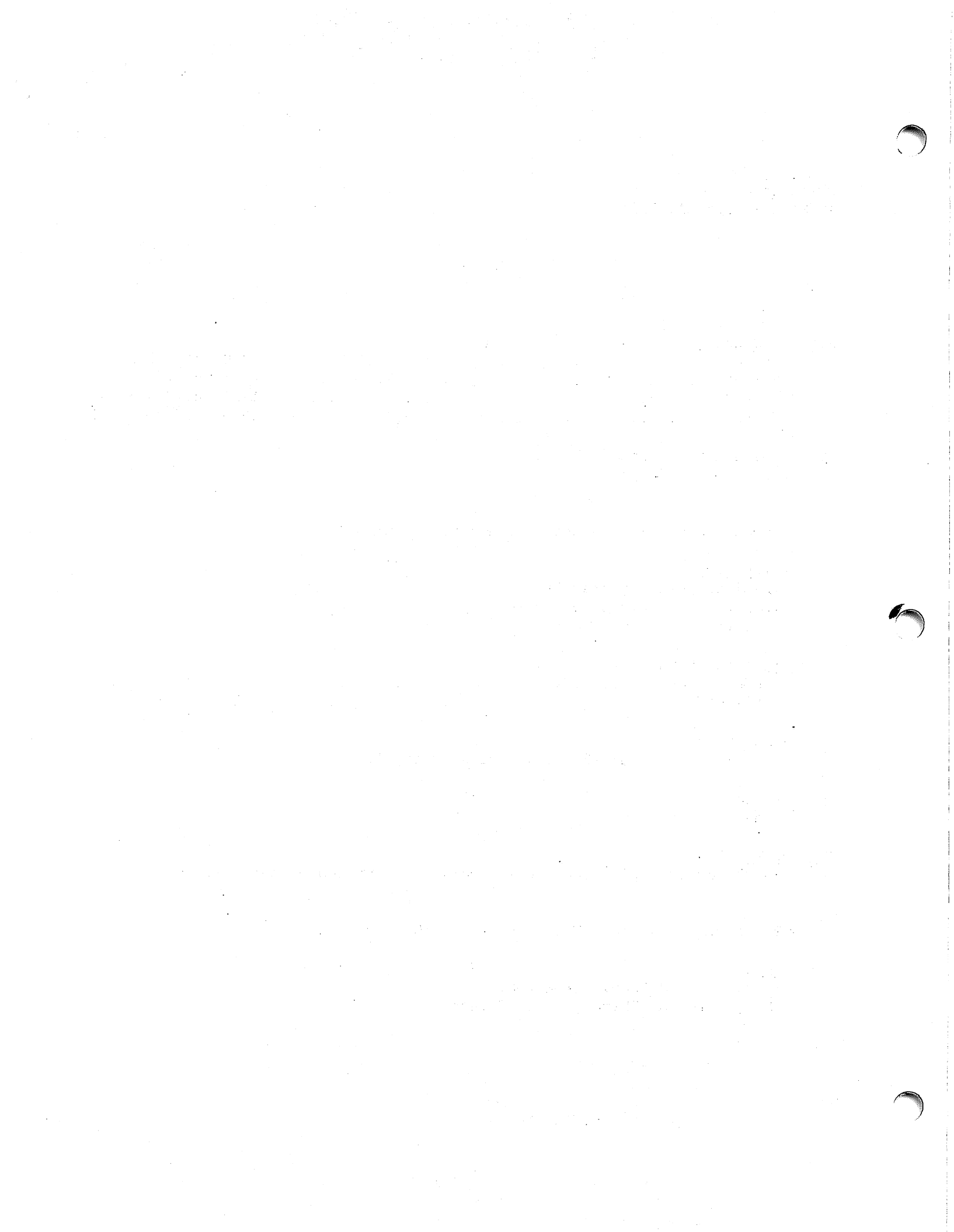

APPENDIX B
HEXADECIMAL CODES

Hex Code	Printer Character
HEX(02)	Start of Hexadecimal Command Sequence
HEX(08)	Backspace
HEX(0A)	Line Feed
HEX(0B)*	Vertical Tab
HEX(0C)*	Top of Form
HEX(0D)	Carriage Return
HEX(0E)	Null or Underscore
HEX(0F)	Null or Terminate Underscore
HEX(1E)	ø
HEX(1F)*	o
HEX(20)	Space
HEX(21)	!
HEX(22)	"
HEX(23)	#
HEX(24)	\$
HEX(25)	%

* Indicates a character that differs from the CRT character set

Hex Code	Printer Character
HEX(26)	&
HEX(27)	'
HEX(28)	(
HEX(29))
HEX(2A)	*
HEX(2B)	+
HEX(2C)	,
HEX(2D)	-
HEX(2E)	.
HEX(2F)	/
HEX(30)	0
HEX(31)	1
HEX(32)	2
HEX(33)	3
HEX(34)	4
HEX(35)	5
HEX(36)	6
HEX(37)	7
HEX(38)	8
HEX(39)	9
HEX(3A)	:
HEX(3B)	;
HEX(3C)*	<
HEX(3D)	=
HEX(3E)*	>

* Indicates a character that differs from the CRT character set

Hex Code	Printer Character
HEX(3F)	?
HEX(40)	@
HEX(41)	A
HEX(42)	B
HEX(43)	C
HEX(44)	D
HEX(45)	E
HEX(46)	F
HEX(47)	G
HEX(48)	H
HEX(49)	I
HEX(4A)	J
HEX(4B)	K
HEX(4C)	L
HEX(4D)	M
HEX(4E)	N
HEX(4F)	O
HEX(50)	P
HEX(51)	Q
HEX(52)	R
HEX(53)	S
HEX(54)	T
HEX(55)	U
HEX(56)	V
HEX(57)	W

* Indicates a character that differs from the CRT character set

Hex Code	Printer Character
HEX(58)	X
HEX(59)	Y
HEX(5A)	Z
HEX(5B)	[
HEX(5C)*	Space
HEX(5D)*]
HEX(5E)*	!
HEX(5F)*	Underscore
HEX(60)*	Space
HEX(61)	a
HEX(62)	b
HEX(63)	c
HEX(64)	d
HEX(65)	e
HEX(66)	f
HEX(67)	g
HEX(68)	h
HEX(69)	i
HEX(6A)	j
HEX(6B)	k
HEX(6C)	l
HEX(6D)	m
HEX(6E)	n
HEX(6F)	o
HEX(70)	p

* Indicates a character that differs from the CRT character set

Hex Code	Printer Character
----------	-------------------

HEX(71)	q
---------	---

HEX(72)	r
---------	---

HEX(73)	s
---------	---

HEX(74)	t
---------	---

HEX(75)	u
---------	---

HEX(76)	v
---------	---

HEX(77)	w
---------	---

HEX(78)	x
---------	---

HEX(79)	y
---------	---

HEX(7A)	z
---------	---

HEX(7B)	§
---------	---

HEX(7C)	¶
---------	---

HEX(7D)	
---------	--

HEX(E4)* Set Home

HEX(E7)* Move (Absolute)

HEX(E8)* Set Left Margin

HEX(E9)* Set Line Feed

HEX(FA)* Reverse Index

* Indicates a character that differs from the CRT character set

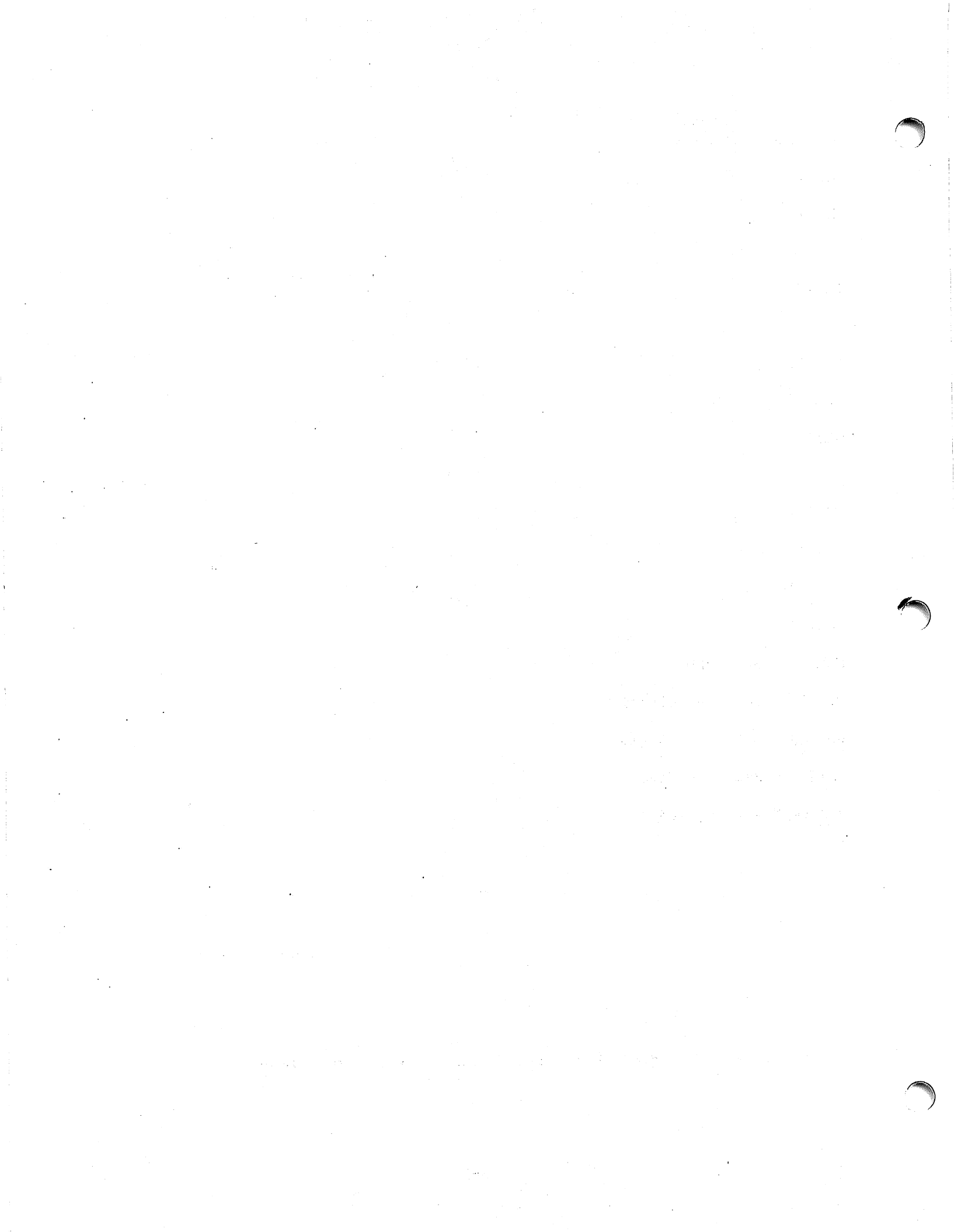

APPENDIX C
 DECIMAL/BINARY 2'S COMPLEMENT CONVERSION

C.1 INTRODUCTION

Binary numbers consist of digits whose values can only be 0 or 1. These binary digits are called bits. Each higher order bit (digit) in a binary number represents a power of 2 greater than the bit to the right of it. For example:

The binary number represented by the bits $X_7X_6X_5X_4X_3X_2X_1X_0$ has a value of

$$X_7(2^7) + X_6(2^6) + X_5(2^5) + X_4(2^4) + X_3(2^3) + X_2(2^2) + X_1(2^1) + X_0(2^0)$$

Thus, if $X_7X_6X_5X_4X_3X_2X_1X_0 = 0000\ 1011$

then its value in the decimal system equals

$$\begin{aligned} &0(2^7) + 0(2^6) + 0(2^5) + 0(2^4) + 1(2^3) + 0(2^2) + 1(2^1) + 1(2^0) \\ &= 0 + 0 + 0 + 0 + 1(8) + 0 + 1(2) + 1(1) \\ &= 11 \end{aligned}$$

Hexadecimal Notation

When used in a hex command, a binary number must be represented in hexadecimal notation. In this representation, a binary number is divided into four-bit groups (from the right), and each group of four bits is expressed by a single hexadecimal character (refer to Table C-1).

Table C-1. Decimal/Binary/Hexadecimal Conversion

Decimal	Binary	Hex	Decimal	Binary	Hex	Decimal	Binary	Hex	Decimal	Binary	Hex
0	0000	0	8	1000	8	-1	1111	F	-8	1000	8
1	0001	1	9	1001	9	-2	1110	E	-9	0111	7
2	0010	2	10	1010	A	-3	1101	D	-10	0110	6
3	0011	3	11	1011	B	-4	1100	C	-11	0101	5
4	0100	4	12	1100	C	-5	1011	B	-12	0100	4
5	0101	5	13	1101	D	-6	1010	A	-13	0011	3
6	0110	6	14	1110	E	-7	1001	9	-14	0010	2
7	0111	7	15	1111	F				-15	0001	1

For example, $\text{HEX}(0B) = \begin{array}{cc} \underline{0000} & \underline{1011} \\ | & | \\ 0 & B \end{array} = 11$

$\text{HEX}(2710) = \begin{array}{cccc} \underline{0010} & \underline{0111} & \underline{0001} & \underline{0000} \\ | & | & | & | \\ 2 & 7 & 1 & 0 \end{array} = 10,000$

In each pairing of hexadecimal characters, the first four digits are called high-order bits, and the four bits on the right are called low-order bits.

Representation of Positive Numbers in 2's Complement

The representation of positive decimal numbers in 2's complement format follows the usual procedure of converting a decimal number to its binary and/or hexadecimal value. For example:

$4 = 0000\ 0100 = \text{HEX}(04)$
 $11 = 0000\ 1011 = \text{HEX}(0B)$
 $10,000 = 0010\ 0111\ 0001\ 0000 = \text{HEX}(2710)$

Conversion of Negative Numbers to 2's Complement

A negative value in binary 2's complement format is formed in two operations. First, express the absolute value of the decimal number in binary or hexadecimal format as shown in the preceding section. Then complement the binary value (i.e., change all 1's to 0's and 0's to 1's) and add 1. You can use Table C-1 to facilitate the conversion of negative values to 2's complement format.

For example:

$-11 = \text{complement } (+11) + 1 = \text{complement of } \begin{array}{cc} 0000 & 1011 \\ 1111 & 0100 \end{array} + 1 = \begin{array}{cc} 1111 & 0101 \\ & + 1 \end{array} = \text{HEX}(F5)$

$-4 = \text{complement } (+4) + 1 = \text{complement of } \begin{array}{cc} 0000 & 0100 \\ 1111 & 1011 \end{array} + 1 = \begin{array}{cc} 1111 & 1100 \\ & + 1 \end{array} = \text{HEX}(FC)$

$-10,000 = \text{complement } (+10,000) + 1 = \text{complement of } \begin{array}{cccc} 0010 & 0111 & 0001 & 0000 \\ 1101 & 1000 & 1110 & 1111 \end{array} + 1 = \begin{array}{cccc} 1101 & 1000 & 1111 & 0000 \\ & & & + 1 \end{array} = \text{HEX}(D8F0)$

NOTE

The high-order bit (leftmost position) indicates the sign associated with the number; for example, 0 = positive (+), 1 = negative (-). Thus, HEX(00) through HEX(7F) are positive, and HEX(80) through HEX(FF) are negative.

To convert a hexadecimal number to its decimal equivalent, follow the same procedure as in the previous examples. For example:

$$\text{HEX}(74) = \text{positive number} = (0111\ 0100) = 64 + 32 + 16 + 4 = 116$$

$$\begin{aligned}\text{HEX}(80) &= \text{negative number} = -(\text{complement}(\text{HEX}(80)) + 1) \\ &= -(\text{HEX}(7F) + 1) \\ &= -(0111\ 1111 + 1) \\ &= -(1000\ 0000) = -128\end{aligned}$$

NOTE

Positive hexadecimal numbers can be translated directly to decimal values by using powers of 16. The hex number represented by

$X_3X_2X_1X_0$ has a value of

$X_3(16^3) + X_2(16^2) + X_1(16^1) + X_0(16^0)$. Thus, if

$X_3X_2X_1X_0 = 02CF$, its decimal equivalent is

$$0(4096) + 2(256) + 12(16) + 15(1) = 719.$$

C.2 CONVERSION OF BASIC NUMERIC VALUES TO 2'S COMPLEMENT

USING THE BASIC BIN STATEMENT

Numeric values can be converted into 2's complement binary numbers with the Wang BASIC BIN statement. The BIN statement converts a BASIC numeric value to binary. However, since the BIN statement produces only a binary value consisting of a single byte (8 bits), the number must be factored by 256 (the minimum value + 1 of the byte) to produce a two-byte number. The following BASIC subroutine receives a numeric value, (presumably an integer value less than 32,766) converts it to 2's complement binary notation, and stores it in the first two bytes of the variable A\$.

```

:10 REM SUBROUTINE TO GENERATE TWO BYTE 2'S COMPLEMENT BINARY NUMBERS
:100 GOSUB' 50 (X1)           X1 = numeric integer value to be converted
                              to 2's complement which will be
                              stored in A$.
.
.
:400 DEFFN' 50 (X)
:404 DIM A$2
:405 IF ABS(X) <= 32766 THEN 410
:408 STOP: PRINT "ABS(X) TOO LARGE"
:410 T = INT (ABS(X)/256)      (Factor 256)
:420 BIN(A$) = T              (Convert to form high-order byte)
:430 BIN(STR(A$,2)) = ABS(X)-T*256 (Convert to form low-order byte)
:440 IF SGN(X) < 0 THEN 450:RETURN (Check if negative, return if positive)
:450 XOR(STR(A$, 1, 2),FF)    (Complement binary value)
:460 ADDC(STR(A$, 1, 2),01)   (Add 1)
:470 RETURN

```

The following routine receives an integer value less than 128, converts it to 2's complement binary notation, and stores it in the one byte variable A\$.

```

:10 REM SUBROUTINE TO GENERATE ONE BYTE 2'S COMPLEMENT NUMBER
:100 GOSUB' 60 (X1)           X1 = Numeric integer value between -128
                              and +127 which will be converted to 2's
                              complement and stored in A$.
.
.
:500 DEFFN' 60 (X)
:505 DIM A$1
:510 BIN(A$) = ABS(X)        (Convert to binary)
:520 IF SGN(X) < 0 THEN 530: RETURN (Test if negative; return if positive)
:530 XOR(STR(A$,1,1),EF)    (If negative, complement)
:540 ADDC(STR(A$,1,1),01)   (Add 1)
:550 RETURN

```

USING THE BASIC 2 BIN STATEMENT

Numeric values can be converted directly into a two-byte, binary number by using the BASIC 2 BIN statement. The following routines can be used on the 2200VP system:

```

:10 REM SUBROUTINE TO GENERATE TWO BYTE 2'S COMPLEMENT BINARY NUMBERS
:100 GOSUB' 50 (X1)
.
.
:400 DEFFN' 50 (X)
:410 DIM A$2
:420 IF ABS(X) <= 32766 THEN 440
:430 STOP: PRINT "ABS(X) TOO LARGE"
:440 Y=ABS(X)
:450 A$=BIN(Y,2)
:460 IF SGN (X) < 0 THEN 470: RETURN
:470 XOR(STR(A$,1,2),FF)
:480 ADDC(STR(A$,1,2),01)
:490 RETURN

```

The following routine is used to convert a number less than 128 to a one-byte, 2's complement value:

```
:10 REM SUBROUTINE TO GENERATE ONE BYTE 2'S COMPLEMENT NUMBER
:100 GOSUB' 60 (X1)
.
.
.
:500 DEFFN' 60(X)
:505 DIM A$1
:510 Y = ABS(X)
:520 A$ = BIN(Y)
:530 IF SGN(X) < 0 THEN 540: RETURN
:540 XOR(STR(A$,1,1),FF)
:550 ADDC(STR(A$,1,1,01))
:560 RETURN
```

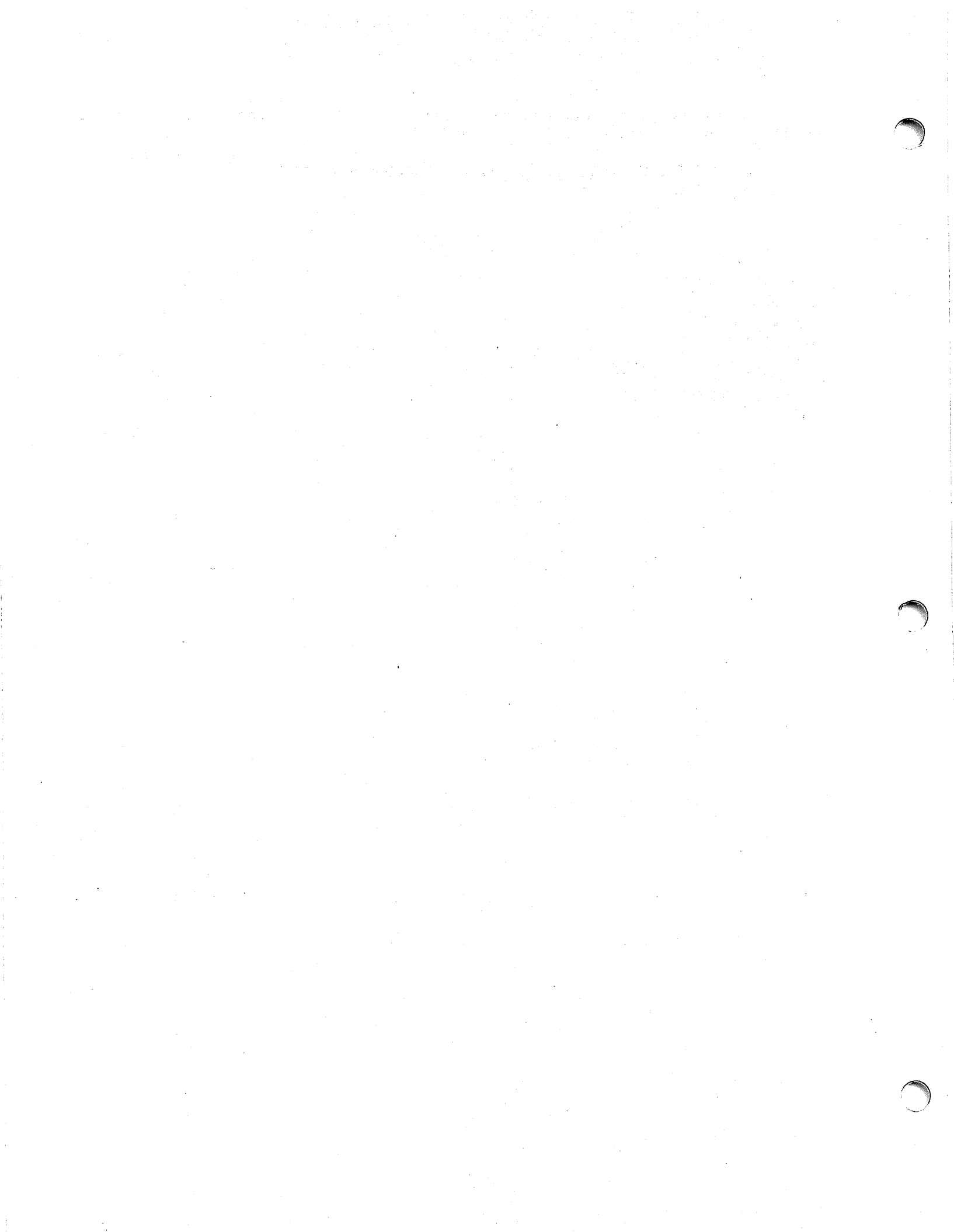

APPENDIX D

TRAILING SPACES [HEX(20)] OR THE HEX(0D) CODE IN AN ALPHA VARIABLE

D.1 TRAILING SPACES [HEX(20)] IN AN ALPHA VARIABLE

When an alpha variable is printed to a peripheral, 2200 BASIC truncates all trailing spaces. This can present problems when the alpha variable is used to send forms positioning vectors to the Model DW/22-20.

For example:

```
:10 DIM A$32
:20 A$ = HEX(E701A90120)
:30 PRINT A$; "SUB-TOTAL"
```

The variable A\$ is dimensioned large enough to hold a number of vector commands. In Line 20, A\$ is set equal to a Relative Move command that should cause the form to be repositioned 425 increments to the right and 288 increments down from the form's home position (HEX (01A9) = decimal 425, HEX (0120) = decimal 288). Normally, the entire vector would be sent to the printer, followed by the ASCII codes for SUB-TOTAL. For example:

```
HEX E7 01A9 0120 5355422D544F54414C 0D00
      |  |
      X  Y          SUB-TOTAL          CR
```

The 2200 BASIC language, however, truncates all trailing spaces (HEX 20) including the last byte of the Y-vector (HEX 0120). Thus, an incorrect code sequence is sent to the printer. For example:

```
HEX E7 01A9 0153 55422D544F54414C 0D00
      |  |
      X  Y          SUB-TOTAL          CR
```

The printer's internal microcode interprets the first code of the ASCII message (HEX 53) as the final byte of the Y-vector component. The printed output will therefore appear in the wrong position on the form, and the first character will be missing.

D.2 HEX(0D) IN AN ALPHA VARIABLE

Depending on the device type selected in the SELECT PRINT statement, the 2200 BASIC always inserts one or two control codes following the occurrence of a HEX (0D) code in an alpha variable. If the device type is 2 (SELECT PRINT 215), the HEX (0D) is followed by a HEX (00); if the device type is 4 (SELECT PRINT 415), the HEX (0D) is followed by a HEX (0A00). These codes are treated as part of the vector in the printers internal microcode.

Example 1: (Device Type 2)

```
:10 SELECT PRINT 215
:20 DIM A$32
:30 A$ = HEX(E7040D0135)
:40 PRINT A$; "SUB-TOTAL"
```

The desired output to the printer is the code sequence:

```
HEX E7 040D 0135 5355422D544F54414C 0D00
      |   |   |   |
      X   Y   SUB-TOTAL   CR
```

The actual code sequence is:

```
HEX E7 040D 0001 355355422D544F54414C 0D00
      |   |   |   |
      X   Y   SUB-TOTAL   CR
```

Example 2: (Device Type 4)

```
:10 SELECT PRINT 415
:20 DIM A$32
:30 A$ = HEX(E7040D0135)
:40 PRINT A$; "SUB-TOTAL"
```

The desired output is the code sequence:

```
HEX E7 040D 0135 5355422D544F54414C 0D0A00
      |   |   |   |
      X   Y   SUB-TOTAL   CR/LF
```

The actual code sequence is:

```
HEX E7 040D 0A00 01355355422D544F54414C 0D0A00
      |   |   |   |
      X   Y (string not printed)   CR/LF
```

APPENDIX E
BIDIRECTIONAL FORMS TRACTOR OPTION

E.1 INTRODUCTION

The model BFT-1 Bidirectional Forms Tractor is an accessory designed for use with the Model DW/22-20 Daisy Printer. When mounted on a printer, the Bidirectional Forms Tractor allows the continuous forward or reverse feeding of form paper in either the forward or reverse direction.

This easy-to-use accessory offers many new applications for the printers, including forms filling, plotting, and superscript/subscript printing. The Bidirectional Forms Tractor accommodates various paper widths and multiform combinations of up to six parts (original plus five copies). The BFT-1 includes racks to support ingoing and outgoing paper flow.

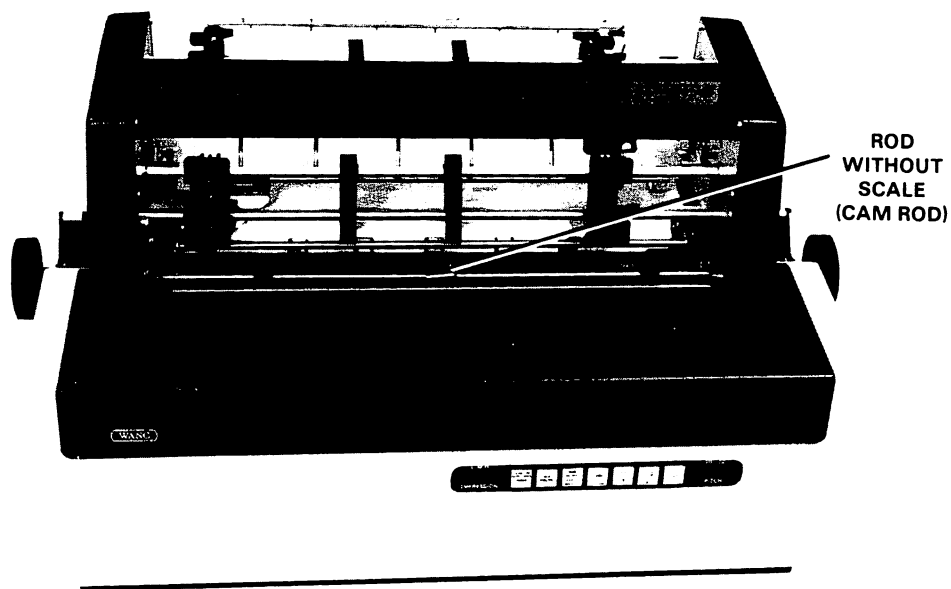

Figure E-1. BFT-1: Bidirectional Forms Tractor

E.2 INSTALLATION PROCEDURES

Perform the following steps to install the Bidirectional Forms Tractor.

NOTE

Before the tractor is mounted on the printer, the paper scale and rod assembly over the platen must be removed and replaced with a rod without a scale (refer to Figure E-1). The rods are easily attached to the printer by a spring-loaded mount.

1. Pull the printer paper bail forward (away from the platen), and then pull the paper release lever to its most forward position.
2. Remove the end covers of the printer, and replace them with the new end covers supplied with the Bidirectional Forms Tractor.
3. Install the paper rack, supplied with the tractor, on the rear cover of the daisy printer. Position left and right brackets over the four tapped holes on the rear of the printer. Insert the four thumbscrews supplied, and tighten. Place the rack into the slots on the brackets.
4. Center the Bidirectional Forms Tractor over the printer. Grip and pull upward the spring-loaded latch release levers (refer to Figure E-2) beneath both left and right end covers of the tractor.
5. Determine that the printer's copy control lever extends through the cut-out on the assembly's left slide bracket, and that the printer's paper release lever extends through the cut-out on the right slide bracket. The copy control lever and the paper release lever will be controlled by the tractor's slide levers (located at the rear of the tractor assembly) during tractor use.
6. Position the left side frame into the bushing groove on the left end of the platen, making sure that both left and right tractor latches engage the platen shaft. Release the latch levers to lock the tractor in place (refer to Figure E-2).
7. Position the two paper supports (refer to Figure E-2) approximately one-third the paper width from each tractor.
8. Replace the paper bail against feeder assembly.

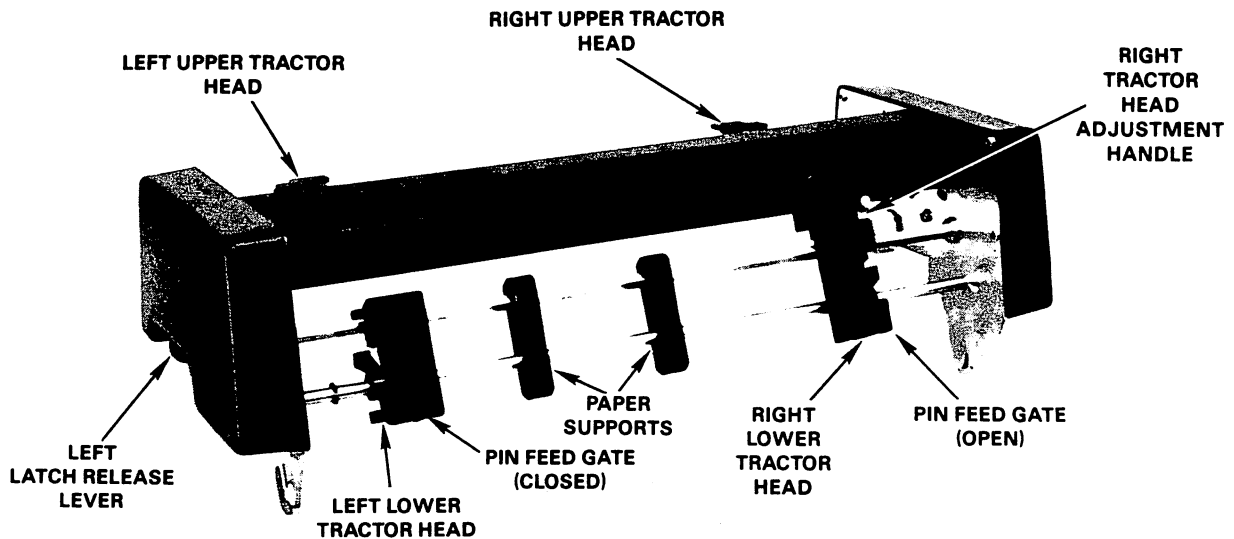

Figure E-2. Bidirectional Forms Tractor

E.3 PAPER INSERTION

Perform the following steps to insert paper:

1. Guide the paper beneath the tilting rack mounted on the rear printer cover. Gently pull the paper and engage the first four holes of the left margin on the four pins of the upper-left tractor head (refer to Figures E-2 and E-3).
2. Adjust the right-hand upper and lower tractor heads for the desired paper width. Note that both right-hand tractors are adjusted with a single handle. Open the pin feed gates on the forms tractor by gently pulling forward on the front of the gates. Engage the first four holes of the right margin on the pins of the upper-right tractor head (refer to Figure E-2).
3. Rotate the platen to advance the paper over the tension rod and under the paper guide until the leading edge of the paper reaches the platen. Pull the right slide lever back (away from the platen) to engage the feed rollers of the printer (refer to Figure E-3).
4. Determine that the paper is positioned in back of the cam rod (refer to Figure E-1).
5. Continue the rotation of the platen until five inches of paper extend in front of the platen. Move the right slide lever forward (towards the platen) to release the feed rollers (refer to Figure E-3).
6. Load the paper into the left and right lower tractors. Close the pin feed gates by gently pushing them back (refer to Figure E-2).

7. Turn the platen knob to position the paper at the top of a page where the first line is to be printed. When printing, the paper should exit over the top of the upper rack towards the back of the printer.
8. Move the left slide lever manipulating the printer's copy control lever as required for multipart paper (refer to Figure E-3). For single sheet paper, the left slide lever must be in the forward position.

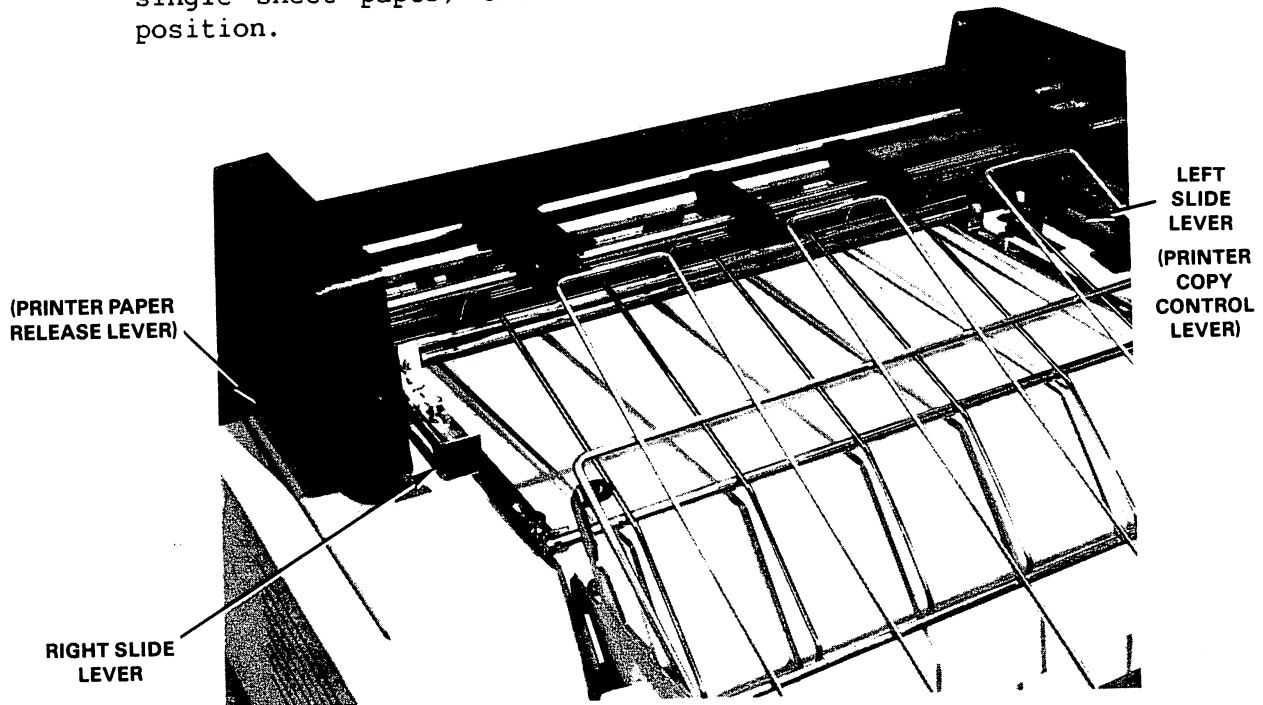

Figure E-3. Tractor Rack and Rod Assemblies

E.4 PRINT REGISTRATION

NOTE

All error limits mentioned in this section are based on a printing rate of six lines per inch.

The home (power-on) position of the left margin is established at the factory. The center line of the first character is approximately 0.45 inch (1.143 cm) from the center line of the tractor head pin hole.

Line spacing from the top of one line to the top of the following line is 0.167 ± 0.015 inch (0.424 ± 0.038 cm) when paper is advanced in either the forward or reverse direction. The actual dimension between any two printed lines on an 11-inch (27.94 cm) page is within 0.023 inch (0.058 cm) of the nominal position. Calculate the nominal position using the line feed rate of one inch (2.54 cm) per six printed lines.

Based on 13.50-inch (34.29 cm) paper, printed lines are parallel to perforations in continuous feed paper within 0.040 inch (0.102 cm) in reverse drive, and 0.035 inch (0.089 cm) in forward drive.

When overstriking in the forward direction, printing and plotting registration is accurate within 0.010 inch (0.025 cm). When overstriking in reverse, registration is accurate within 0.030 inch (0.076 cm). Plotting accuracy is suitable for highlighting and visual aids. Do not use multipart paper for a plotting operations.

E.5 PAPER SPECIFICATIONS

The Bidirectional Forms Tractor can accommodate various widths of paper from 2.0 to 13.50 inch (5.08 to 34.29 cm) (center-hole to center-hole). The Forms Tractor option is adjustable for multicopy combinations of up to 6 copies.

Continuous form paper thickness may range from 0.003 inch (0.008 cm) (14 lb. substance, single copy) to 0.027 inch (0.069 cm) thick (various multicopy combinations up to six parts). The cover sheet of multicopy forms must be of at least 12 lb. substance.

Multipart forms must be securely fastened at all four corners, but not glued, stapled, or taped. Forms perforations must be of sufficient strength to withstand normal paper handling force of the printer of approximately one inch per pound. Paper substance exceeding 24 pounds (90g/sq m) bond or excessive bulging of forms, particularly at perforations, may reduce the specified performance.

Holes in continuous form paper must be 0.156 ± 0.005 inch (0.396 ± 0.013 cm) in diameter, and on a $0.500 \pm .005$ inch (1.27 ± 0.013 cm) pitch.

Reverse feeding is not recommended across perforations.

E.6 BIDIRECTIONAL FORMS TRACTOR SPECIFICATIONS

Physical Characteristics

Height	6.75 in. (17.15 cm)
Width	21.50 in. (54.61 cm)
Depth	8.40 in. (21.34 cm)
Weight	6.00 lbs. (2.70 kg)

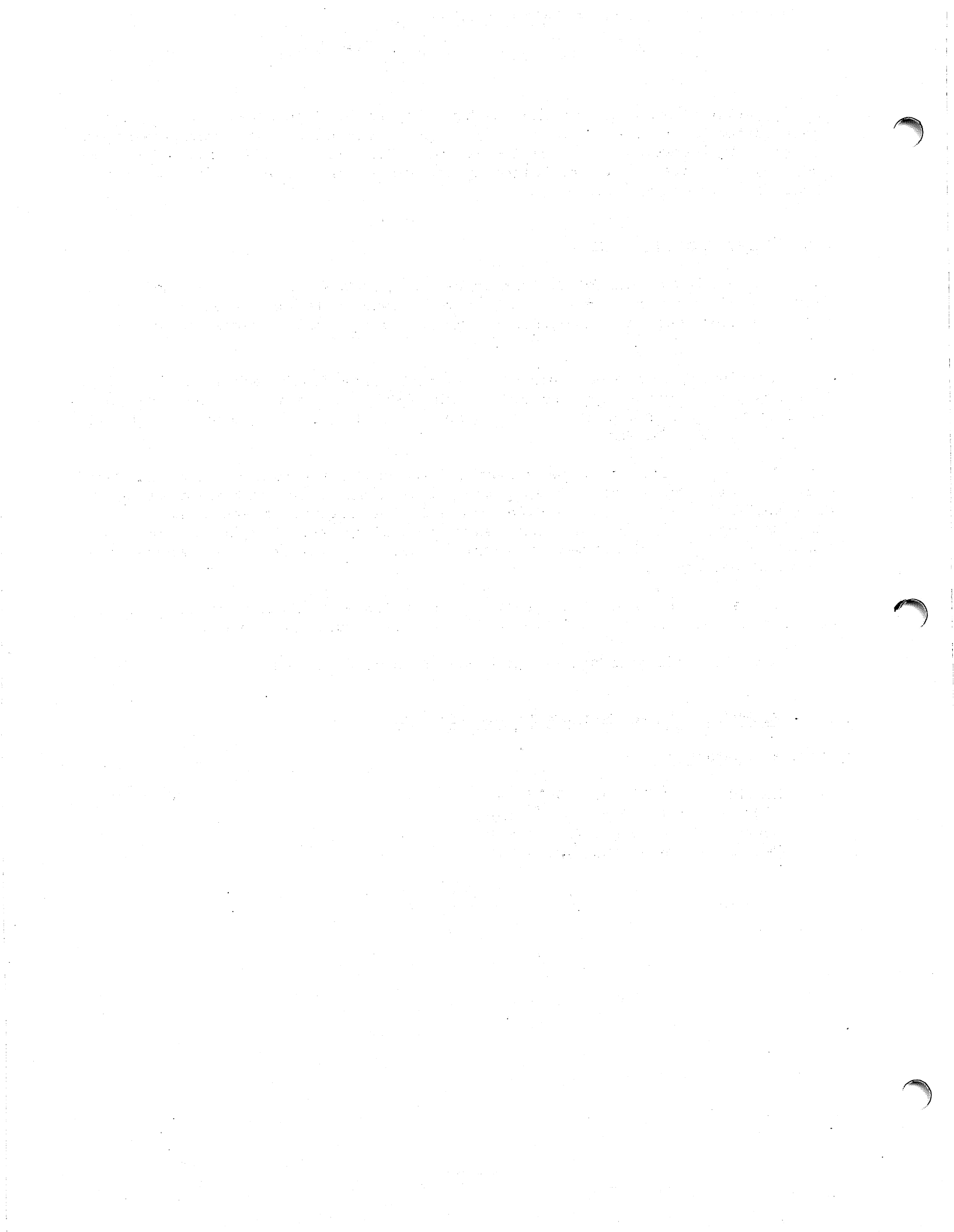

APPENDIX F
TWIN SHEET FEEDER OPTION

The Twin Sheet Feeder (refer to Figure F-1) is an electronically controlled Wang 2200 Series accessory designed for use with the Model DW/22-20 printer. The feeder automatically and continuously feeds single sheets of paper into the printer as they are needed.

The Twin Sheet Feeder was designed for ease of installation and use. You can place up to two hundred sheets of paper in each of two easy-to-load feed bins. Paper automatically feeds into the platen as needed, and is adjusted for the correct top margin. When printing is complete, or when the bottom margin is reached, sheets are automatically ejected and stacked sequentially in the stacker tray. Operator intervention is necessary only for loading the Twin Sheet Feeder, refilling its paper bins when empty, and removing printed documents from the stacker when printing is complete.

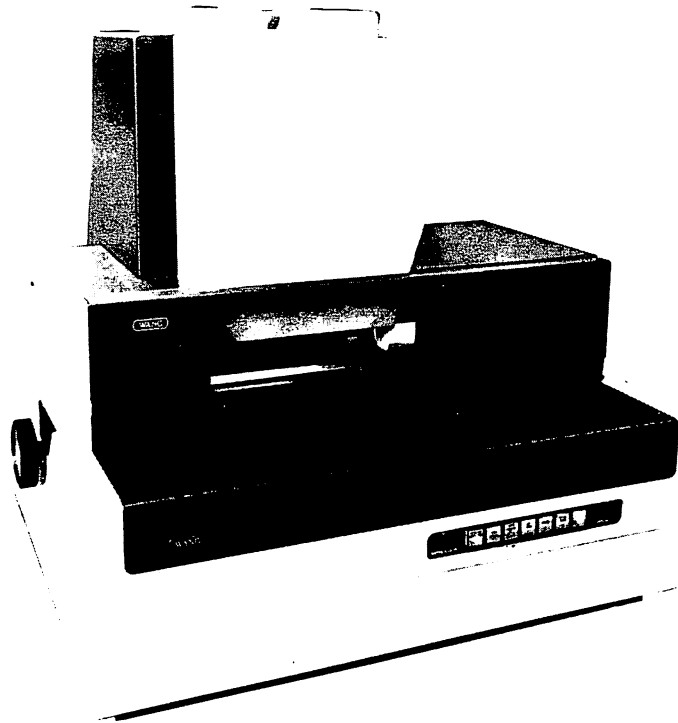

Figure F-1. Twin Sheet Feeder

F.1 OPERATIONAL FEATURES

Paper Feed Bins

The two paper feed bins (refer to Figure F-2) hold the paper and feed it into the printer one sheet at a time, as needed. Each bin can be filled with paper of different grade, stock, length, or thickness, according to the specifications of both feeder and printer. For example, you can load one bin with bond and the other with letterhead, or one bin with colored draft paper and the other with paper of a preprinted format.

Bin selection is fully programmable with a set of control codes and can also be controlled manually by the printer's front panel switches, thus allowing each page to feed automatically to the platen from either bin. Therefore, a document can be readily printed on all letterhead (both bins letterhead), on all bond (both bins bond), with page one on letterhead and the remainder on bond (one bin bond, the other letterhead), or in any other desired combination.

Loading Lever

The loading lever (refer to Figure F-2) is used to open and close the paper feed bins. Positioned at LOAD, the lever opens the bins so that paper can be loaded. Positioned at RUN, the lever closes the bins.

Stacker Tray

The stacker tray (refer to Figure F-2) holds the printed pages as they are ejected from the printer. Finished documents are automatically stacked in sequential order.

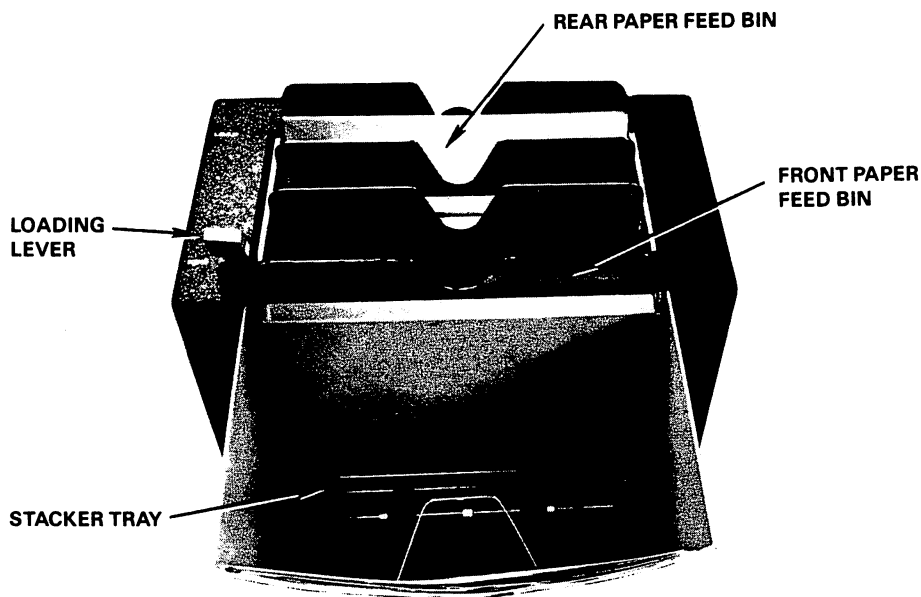

Figure F-2. Feeder Bins and Loading Lever

Silencer Hood

The Silencer Hood is designed to cut down on printer noise with the added advantages of a hinged door and an observation window. The hinged door provides easy access to the page presently in the platen. The observation window allows you to observe the page being printed without having to lift the silencing cover.

Handles

The handles, recessed on both sides of the Twin Sheet Feeder, are designed for a dual purpose. While these handles are obviously for easier handling of the Twin Sheet Feeder, they also control the clamps that hold the feeder in place on the printer. When the handles are pulled up and forward, the clamps open. When the handles are released, the clamps close. This allows you to pick up the feeder and place it on the printer with one movement. The same applies to removing the feeder from the printer; lifting it by the handles releases the clamps, and the feeder can then be easily moved.

Cable

The electric cable, located on the back of the feeder (refer to Figure F-3), screws into the jack on the back of the printer. Since the feeder is electrically cabled to the printer, it is automatically turned on and off with the printer.

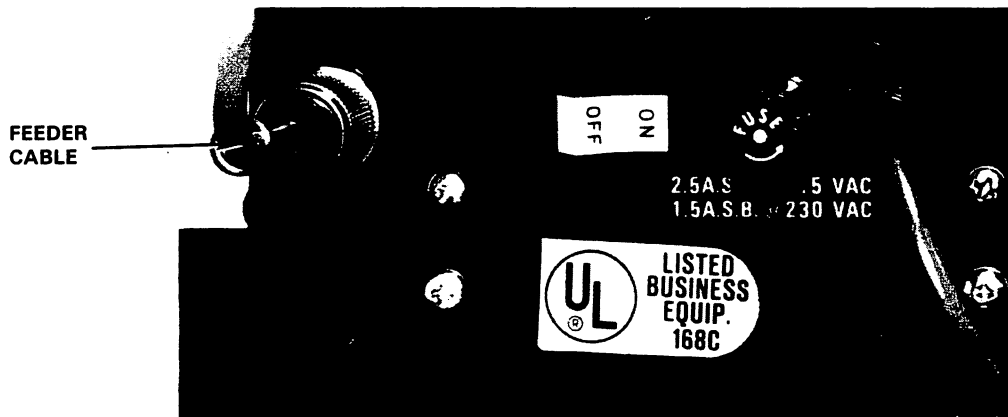

Figure F-3. Cable Attachment

F.2 INSTALLATION PROCEDURES

Installation

Perform the following steps to install the Twin Sheet Feeder:

NOTE

Before installing the Twin Sheet Feeder, turn off the printer power. If you do not turn the power off, once the feeder is installed, a power-on reset code sequence [HEX(020D0C030F)] must be executed before any printing can be done.

Be sure the printer has been properly adjusted by a Wang service representative before the Twin Sheet Feeder is installed.

1. Remove any paper remaining in the platen before installing the Twin Sheet Feeder on the printer.
2. Remove the paper scale and pull the paper bail forward. A spring-loaded mount, which you can operate easily, attaches the scale to the printer.
3. Holding both handles, lift the feeder and lower it onto the printer. The clamp automatically closes when the handles are released.
4. Attach the electric cable to the back of the printer (refer to Figure F-3) and turn the printer on.
5. Position the loading lever in the LOAD position.

Removing the Feeder from the Printer

The Twin Sheet Feeder may be easily removed from the printer to enable the printer to use continuous paper or odd-sized forms. To remove the feeder, first disconnect the electric cable attaching the feeder to the printer. Then lift the feeder by its side handles and remove.

When the Twin Sheet Feeder is not on the printer, it must be put on the specially designed stand to prevent it from being damaged.

NOTE

Before removing the Twin Sheet Feeder, turn off the printer power. If this is not done, once the feeder has been removed, a power-on reset code sequence [HEX(020D0C030F)] must be executed before any printing can be done.

Be sure the electric cable that connects the feeder to the printer is disconnected before removing the feeder from the printer.

F.3 PAPER INSERTION AND GENERAL MAINTENANCE

Paper Insertion

Perform the following steps to insert paper into the Twin Sheet Feeder:

NOTE

Only use the size of paper specified for the Twin Sheet Feeder model being used (see Section F.6).

Do not use copy-grade paper. Instead, use bond paper having a rag content of no more than 25%. Observe the correct paper weight specifications as listed in Section F.6.

1. Deselect the printer. Press the Top of Page switch on the printer's front panel to make certain that the platen is clear of paper.
2. Position the feeder's loading lever in the LOAD position (refer to Figure F-2). Remove any paper which may remain in the paper trays.
3. Fill both bins with paper of the appropriate size (refer to Section F.6). Remove, restack, and reload any paper remaining in the bins at this time. It is recommended that paper be fanned before insertion and that it be loaded loosely.
4. Position the loading lever to RUN. The feeder is now ready to accommodate the next PRINT command sent to the printer.

Paper Out Indicator

When the paper supply of the currently selected bin is exhausted, the feeder stops any feeding operation from that bin, the printer halts, and the printer's Change Paper indicator lights. Any data sent to the printer is saved in the printer buffer while you load new paper into the empty feeder bin. Feeding and printing can then be resumed without loss of data.

General Maintenance Guide

The following list contains some procedures that you must follow carefully in order to ensure the smooth operation of the Twin Sheet Feeder:

1. Keep the loading lever in the RUN position while the feeder is operating.
2. Do not overload. Do not load more than 200 sheets of paper per feeder bin.

3. Remove paper from the platen and paper bins each night. Humidity can cause the paper to curl.
4. Do not feed multiple copy forms as serious paper jams will result.
6. Do not use forms with a top margin of less than 0.5 inch (1.27 cm).
7. Do not manually roll sheets back into the platen.
8. In the event of a paper jam, deselect the printer. Do not shut off the power. Shutting off the printer will cause the loss of data from the print queue.

F.4 MANUAL OPERATION OF THE TWIN SHEET FEEDER

While cabled to the printer, the Twin Sheet Feeder automatically modifies the operation of the printer's Top of Page switch to enable both front and rear bin feeding, as well as clearing the platen without a feed.

Pressing the Top of Page switch clears the platen and feeds paper from the selected bin.

F.5 PROGRAMMABLE OPERATION OF THE TWIN SHEET FEEDER

You can operate the Twin Sheet Feeder under program control via the printer control codes discussed in Appendix D of this manual. Four additional hex code sequences provide special functions to the feeder operator. Commands are available to enable feeding from either the front or rear bin, clearing the platen without a paper feed, and setting the bottom margin of each sheet fed to the platen. A fifth code, HEX (0C), while ordinarily the printer Top of Form code, is modified during feeder use to serve as a Clear Platen and Form Feed command.

Bin Selection [HEX(0206020F) or HEX(0206010F)]

You can use a multibyte sequence, triggered by the Escape code HEX(02), to select either the front or rear paper bin for paper feed. Paper is fed from a selected bin until the other bin is selected by a hex command. Nevertheless, whenever the printer is powered on, paper feed control is returned to the rear bin by default.

The hex commands controlling bin selection are

- . HEX(0206020F) - Select front bin
- . HEX(0206010F) - Select rear bin

Clear Platen HEX(02030F)

This command causes the sheet currently in the platen to be cleared and stacked without causing a new sheet to be fed to the platen.

Form Feed HEX(0C)

While the feeder is attached to the printer, the Top-of-Form [HEX(0C)] command causes the sheet currently in the platen to be cleared and a new sheet is fed from the currently selected bin.

Select One-Half Inch Top Margin HEX(020101080F)

When paper is fed from one of the Twin Sheet Feeder bins, it stops at a point one inch (2.54 cm) below the paper's top edge from which point printing may commence. However, you may want to begin printing at a location one-half inch from the top edge. In this case, printing the command sequence, HEX(020101080F), causes all subsequent pages fed to the printer to stop one-half inch from the top edge of the sheet.

When used in any application, this sequence should be preceded by a Power On Reset command [HEX(020D0C030F)] and should be the first output sent to the printer. The one-half inch option remains in effect until the occurrence of another Power On Reset sequence, or until the printer is powered off and on.

Set Form Length HEX(020C0102YYYY0F)

The Set Form Length command enables you to specify the length of the printing area of each sheet to a length other than the default length of 59 lines (from six lines below the top of the sheet to one line above the bottom) or the optional length of 62 lines (from three lines below the top of the sheet to one line above the bottom). This may be done in multiples of 1/48 inch, measured from the 1.0 or 0.5 inch top margin of the sheet to approximately 1.0 inch from the bottom margin. The YYYY sequence represents a positive hexadecimal value representing the desired form length in the number of 1/48 inch increments (refer to Table 6-1 for converted values). The form length is thus set as the bottom margin for all printing, plotting, and forms-filling operations per sheet. Whenever a sheet reaches this length, an automatic form feed is executed, clearing the current sheet and feeding a new sheet from the currently selected paper bin. Printing automatically continues on the newly fed sheet.

Example:

```
:PRINT HEX(020C010201B00F)
```

This command causes an automatic form feed at 9.5 inches from the top edge of the paper.

NOTE

In exceptional cases, when application programs designed to position data on preprinted, continuous forms are run using the Twin Sheet Feeder, output can be shifted two characters to the right of the intended left margin. This is because the single-directional forms tractor mounts on the printer in such a way that the power-on home position of the carriage is at the physical left edge of the paper. When the Twin Sheet Feeder is mounted, however, the power-on home position is approximately two 10-pitch characters to the right of the paper's left edge.

The code sequence, HEX(020101040F), can be implemented to minimize the effects of this problem on existing software packages. When this sequence is used, each time a line of printed data is sent to the daisy printer, characters that would appear in the first two character positions of a line are deleted. In effect, this shifts the remaining portion of a line two character positions to the left. This command remains in effect until a Power-On Reset sequence [HEX(020D0C030F)] is executed or the printer is powered off and on.

Example:

```
100 PRINT "0123456789"  
110 PRINT TAB(4); "ABC"  
120 PRINT HEX(020101040F)  
130 PRINT TAB(4); "ABC"  
:RUN  
0123456789  
    ABC  
    ABC
```

F.6 PAPER SPECIFICATIONS

Use the following paper requirements to ensure effective use of the Twin Sheet Feeder:

Paper Sizes

<u>Model</u>	<u>Printer</u>	<u>Paper Sizes</u>
TSF-51	DW/22-20	8.50 x 11 in. (21.59 x 27.94 cm) 8.50 x 14 in. (21.59 x 35.35 cm)
TSF-53	DW/22-20	8.25 x 11 in. (21.10 x 27.94 cm) 8.25 x 14 in. (21.10 x 35.35 cm)

Paper Grade

16 lb bond (\pm 1.10 lb) [60.10 g/m² (\pm 4.14 g/m²)]

20 lb bond (\pm 1.10 lb) [75.13 g/m² (\pm 4.14 g/m²)]

24 lb bond (\pm 1.10 lb) [90.16 g/m² (\pm 4.14 g/m²)]

Rag content between 0% and 25% recommended.
Copy-grade paper not recommended.

F.7 TWIN SHEET FEEDER SPECIFICATIONS

The following list contains the specifications for the Twin Sheet Feeder:

Size

Height 15.0 in. (38.10 cm)
Depth 14.0 in. (36.56 cm)
Width (TSF-51 and TSF-53) 23.5 in. (59.69 cm)

Weight

15.0 lb (6.8 kg)

Capacity

200 sheets per feed bin
400 sheets total

Printing Area

Top Margin (default) 1.0 in. (2.54 cm)
Top Margin (optional) 0.5 in. (1.27 cm)
Bottom Margin 1.0 in. (2.54 cm)
Left Margin 3/8 in. (0.95 cm)
Right Margin 1/8 in. (0.32 cm)
Form Length (default) 59 lines per 8.5 x 11 inch form
Form Length (optional) 62 lines per 8.5 x 11 inch form

Power Requirements

Power is derived from the printer.

Accessories

A stand is provided to hold the feeder when not in use.

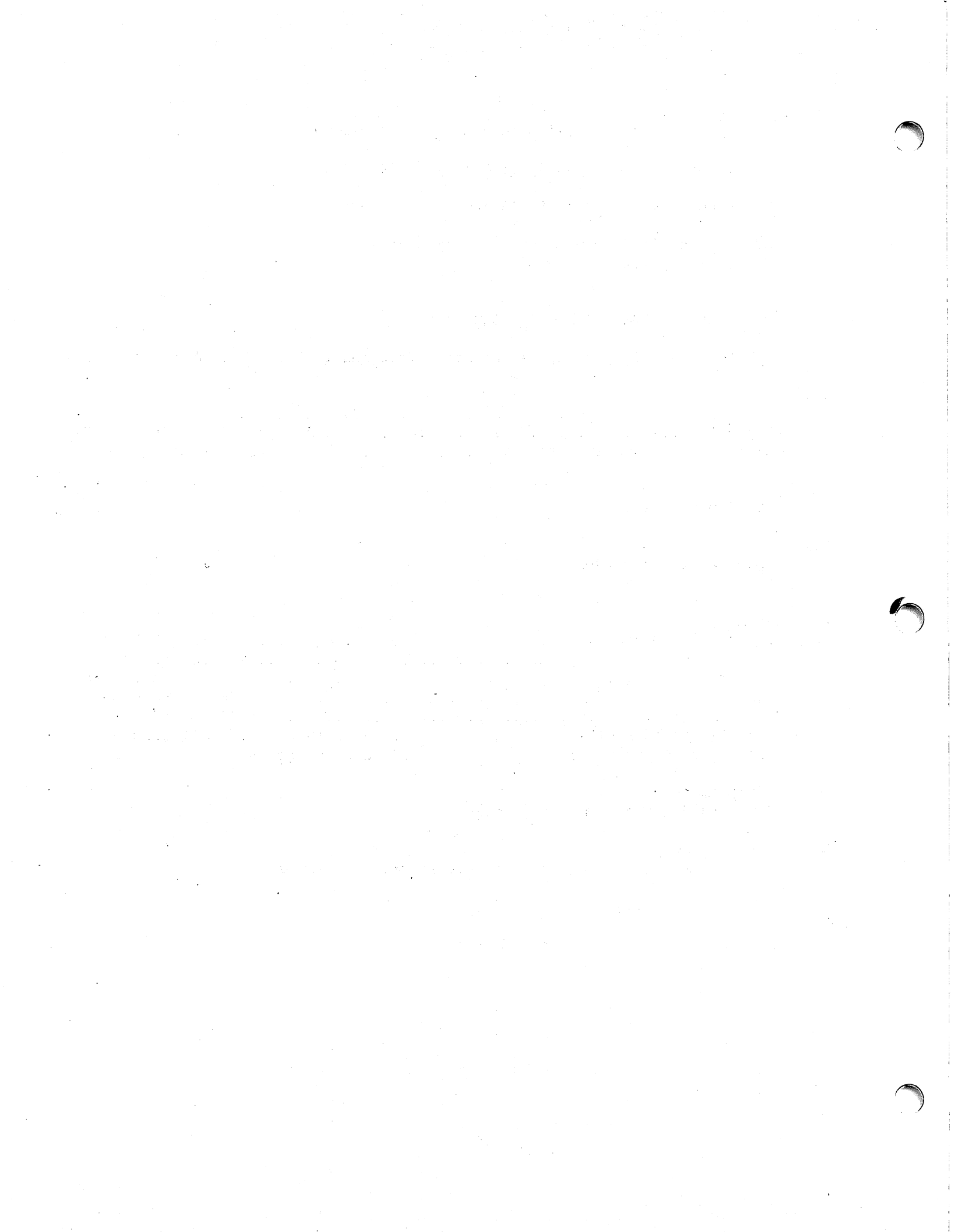

APPENDIX G
DIRECT ACCESS VERTICAL FORMAT UNIT (DAVFU)

G.1 INTRODUCTION

Vertical formatting determines the number of lines to be printed and the amount of blank space to be left between lines on a page of output. Most applications require a form that is 11 inches (27.9 centimeters) long, with output single-spaced or double-spaced. A program, stored in the printer, determines the type of vertical formatting to be used through its defaults or from information that you supply. Vertical formatting for the DW/22-20 is controlled by the 12-channel Direct Access Vertical Format Unit (DAVFU). This method is described in the following sections.

When the printer is powered on or when a Power-On Reset sequence [HEX(020D0C030F)] is executed, the DAVFU defaults to 6 lines per inch and 66 lines per page. You can control line feed size by using the Set Line Feed Size command sequence described in Appendix 6.2. When changing line feed size, you must load an appropriate VFU format before attempting to print. Line feed size cannot be changed within a page. You should first execute a Top-of-Form command before loading the proper VFU format and setting the corresponding line feed size.

You can accomplish vertical formatting in three ways. For most applications, the use of Hex codes for tabulation to VFU default tab stops will suffice. For more complicated applications, such as forms that necessitate frequently changing vertical format, you can choose between writing a DAVFU program or using the Vertical Format Control utility (@2273VFU) on the system platter. Because writing a DAVFU load operation is a somewhat complicated process, the utility is recommended. The Vertical Format Control utility can establish most formats that can be written, and may be accessed and used according to the procedures described in Section G.2. The procedures for writing a DAVFU formatting program are discussed in Section G.3.

G.2 VERTICAL FORMAT CONTROL UTILITY (@2273VFU)

Accessing the Utilities Menu

You can access utilities through a Utility menu which is available through the system platter. The following two commands will display this menu:

SELECT DISK xxx (where xxx = the disk device address of the system utilities)

LOAD RUN

Utilities requiring operator-entered information will display a series of prompts requesting this information. In all cases, type in the necessary response and press the RETURN key; the utility then requests additional information or perform the required procedure.

Vertical Format Control Utility

The Vertical Format Control utility (@2273VFU) allows you to define and edit the vertical format of the DW/22-20 Printer DAVFU without the difficulty of programming long code sequences. You can create, edit, test, and save format data on disk for loading into the DAVFU. Each time the utility is used, you indicate whether to load a previously created format file or create a new one.

In creating a new vertical format, you respond to operator prompts and specify the number of lines per page, the number of lines per inch, and the location of the bottom-of-form. Once you supply this information, an N x 12 grid appears on the CRT screen, where N is the specified number of lines and 12 is the number of channels of the DAVFU. You can edit the format by entering tabs indicating top-of-form in Channel 1 of Line 1 and bottom-of-form in Channels 1 and 2 after the last line to be printed. Also, you can set tabs in the channels of other lines to indicate vertical stops.

Loading a Utility-Defined Vertical Format

You can load a vertical format created by the Vertical Format Control utility by executing the following sequence of statements in the program:

```
DIM T$(128)2
DATA LOAD DC OPEN T "Filename" (where Filename = name of user file)
DATA LOAD DC T$( )
$GIO/xyy, (A000,G$) T$( ) (where xyy = printer address)
```

G.3 FORMATTING USING THE DAVFU

The Direct Access Vertical Format Unit consists of a format memory and associated control codes. The DAVFU is particularly useful for printing special forms or printing reports requiring more than one vertical format. Formatting information is supplied by a user-written program and loaded into the DAVFU before printing. This program overrides previous formatting information resident in the Vertical Format Unit.

Load DAVFU: HEX(021Ddddd ... 1EOF)

If the Vertical Format Control utility is not used to load the DAVFU, it is necessary to write a program defining the vertical format control sequence. The DAVFU has 12 channels and a maximum length of 144 lines. In the formatting sequence, each print line on the form should be represented by 2 bytes (16 bits), with particular bits used to indicate every channel having a tab stop for that particular line. A byte is represented by a 2-digit Hex code. Therefore, each line of the form should be represented by a 4-digit Hex code. A table of the Hex codes that represent bit patterns may be found in Appendix C. The bit representation for each channel of the DAVFU may be found in Table G-1. The variable Cn is used where C = channel and n = number.

Use the following Hex sequence format for all DAVFU loading operations:

HEX(021Ddddd ... 1EOF)

where: dd = standard DAVFU byte pairs

Every sequence must begin with HEX(021D), the Hex code for DAVFU load. This code should be followed with the top-of-form code, 4140, placing a 1 bit in the Channel 1 of the first line. No other tab stops should appear in either byte of the first line. Channel 1 should be used exclusively to mark top-of-form and bottom-of-form.

In a DAVFU formatting program, the Bit 40 should be on for both bytes of each format line code. (If this is not done, the diagnostic error sequence "VFU Bit 6 Not Set" will be illuminated.) For example, a line with the Hex sequence 4040 has no tabs in any channel. As another example, the Hex sequence 4264 has Bit 40 on and a tab stop in Channel 2 (02) of the first byte. The second byte is composed of Bit 40 plus a tab stop in Channel 12 (40 + 20 = 60) and Channel 9 (04) in the second byte.

Table G-1. DAVFU Data Loading Format

	1st Half of Byte 1				2nd Half of Byte 1				1st Half of Byte 2				2nd Half of Byte 2			
	7 80	6 40	5 20	4 10	3 08	2 04	1 02	0 01	7 80	6 40	5 20	4 10	3 08	2 04	1 02	0 01
BIT POSITION																
CHANNEL NUMBERS	0	1	C6	C5	C4	C3	C2	C1	0	1	C12	C11	C10	C9	C8	C7
START CODE	0	0	0	1	1	1	0	1	(See Byte 1)							
FIRST LINE (Top-of-form required)	0	1	0	0	0	0	0	1	0	1	0	0	0	0	0	0
SECOND LINE	0	1	0	0	0	0	1	0	0	1	0	0	0	0	0	0
(continue as needed)																
BOTTOM-OF-FORM	0	1	0	0	0	0	1	1	0	1	0	0	0	0	0	0
SKIP LINE (optional)	0	1	0	0	0	0	0	0	0	1	0	0	0	0	0	0
TOP OF FORM	0	1	0	0	0	0	0	1	0	1	0	0	0	0	0	0
STOP CODE	0	0	0	1	1	1	1	0	(See Byte 1)							

Top-of-form should be followed by a succession of 2-byte codes, each representing a line until the desired form length is reached. Bottom-of-form is represented by a tab in Channels 1 and 2 of the code representing the desired last line of text. This code is 4340 (40 bit is on, and 01 + 02 = 03). When the bottom-of-form is reached, the printer automatically skips to the next top-of-form. Since bottom-of-form actually indicates the final printed line, it is necessary to insert several more blank lines (4040) until the last physical line on the form is reached. At this line (Line 66, for example) another top-of-form code (4140) should be inserted. The Hex code (1E) should then terminate the DAVFU load.

The entire string of codes in the DAVFU load operation must contain an even number of digits; otherwise the printer will enter a DAVFU-memory-not-loaded condition. To prevent this occurrence, break up the formatting sequence with a series of Hex code statements.

Examples

The following is an example of a DAVFU formatting program for the VP, MVP, LVP, and SVP. Each Hex code or 2-byte code has been labeled according to a specific function. Obviously, regular users would not require a form with so few print lines.

Example 1:

```
10 SELECT PRINT 215(0)
20 PRINT HEX(021D414040404240464040404040404043404040404041401E0E);
```

Load DAVFU
 Top-of-Form
 Line without tabs
 Tab in Channel 2
 Tab in Channels 2 & 3
 Three lines without tabs
 Bottom-of-Form
 Blank line
 Blank line
 Top-of-Form
 Stop DAVFU load

The following sample DAVFU program calls for 15 lines of text printed on a 20-line form, with different tabbing formats set in Channels 2, 3, 9, and 11. Table G-2 illustrates the tabulation scheme for the 12 channels and 20 lines of the program in Example 2.

Example 2:

```
10 SELECT PRINT 215(0)
20 PRINT HEX(021D4140424044404244404046404050424044404240405446404040
42404340404040404040404041401E);
```

Table G-2. Sample DAVFU Tabulation Scheme

Line	Channel Numbers												Code
	1	2	3	4	5	6	7	8	9	10	11	12	
1	T												4140
2		T											4240
3			T										4440
4		T							T				4244
5													4040
6		T	T										4640
7											T		4050
8		T											4240
9			T										4440
10		T											4240
11									T		T		4054
12		T	T										4440
13													4040
14		T											4240
15	T	T											4340
16													4040
17													4040
18													4040
19													4040
20	T												4140

Example 2 will work effectively if you are using a 2200VP, MVP, LVP or SVP system, as long as you specify a line length of 0 in the SELECT statement and follows the stop DAVFU load code sequence with a semicolon. These actions suppress any carriage returns that the system might otherwise generate.

When a formatting program is created for a form with 66 vertical lines, it may become unwieldy, leaving far more room for error. Therefore, you may want to break down your DAVFU formatting programs in the following fashion:

```

10 SELECT PRINT 215(0)
20 PRINT HEX(021D);           :REM START OF DAVFU LOAD
30 PRINT HEX(4140);           :REM TOP-OF-FORM
40 PRINT HEX(4240);           :REM LINE TWO - TAB STOP IN CHANNEL 2
50 PRINT HEX(4440);           :REM LINE THREE - TAB STOP IN CHANNELS 2 & 3
60 PRINT HEX(4244);           :REM LINE FOUR - TAB STOP IN CHANNELS 2 & 9
.
.
.
170 PRINT HEX(4340);          :REM LINE 15 - BOTTOM-OF-FORM
180 PRINT HEX(4040);          :REM LINE 16 - BLANK LINE
.
.
.
210 PRINT HEX(4140);          :REM CLOSING TOP-OF-FORM
220 PRINT HEX(1E);            :REM STOP DAVFU LOAD

```

A less cumbersome means of loading the same program is the BASIC \$GIO command. When using the \$GIO command, you should assume that the DAVFU formatting sequence is an array and dimension it as DIM A\$(128)2. The first byte of A\$() should be HEX(02), the escape code; the second byte of A\$() should be HEX(1D), the DAVFU loading command; the third byte should have the value HEX(4140), the top-of-form code; and so on. The proper command for loading the DAVFU program in this manner is:

```

10 $GIO/215 (A000,G$) A$()

```

Because you can reference a particular channel from within a print routine, the DAVFU formatting program can be used to output data requiring different formats. The various channels of the DAVFU are referenced by using the Vertical Skip control code as described in Section G.4.

G.4 DAVFU CONTROL CODES

Vertical Skip: HEX(0201021Fxx0F)

The Vertical Skip command allows you to skip a specified number of lines on a form or to the next tab stop in a specified DAVFU channel. The Vertical Skip command sequence has the following format:

HEX(0201021Fxx0F)

where: xx = 0a to advance the platen to the next tab stop defined in Channel a (a must be a Hex digit from 1 to C)

xx = 1a to advance the platen a lines (a must be a Hex digit from 0 to F)

The Vertical Skip sequence is executed before the current contents of the line buffer are printed.

—NOTE—

If there is no tab stop defined on Channel a, the printer will deselect and an error code will light. If there is no tab stop between the current platen position and the next top-of-form, the platen will not stop at the top-of-form but will continue until it encounters the first tab stop in that channel following the top-of-form.

Vertical Tab HEX(OB)

This Vertical Tab code advances the paper to the next preset vertical tab location in Channel 2. Channel 2 is defined as the vertical tab channel.

G.5 DAVFU ERRORS

A number of error conditions may arise when attempting to load the DAVFU. Such errors result in a failure to load the DAVFU, causing the printer to go off-line. In some cases, an error code is displayed by the diagnostic error indicators (refer to Figure 2-4). The following conditions are error conditions:

- Attempting to create a formatting program over 144 lines in length without specifying the end of the load with a bottom-of-form code or dummy top-of-form code. (In this instance, the "VFU Greater Than 144 Lines" diagnostic error sequence will be illuminated.)
- Neglecting to set Bit 40 to 1 in each byte. (In this instance, the "VFU Bit 6 Not Set" diagnostic error sequence will be illuminated.)
- Loading a program with an odd number of data bytes between the HEX codes 1D and 1E.
- Neglecting to follow the DAVFU start code 1D with a top-of-form code (4140) in the next byte.

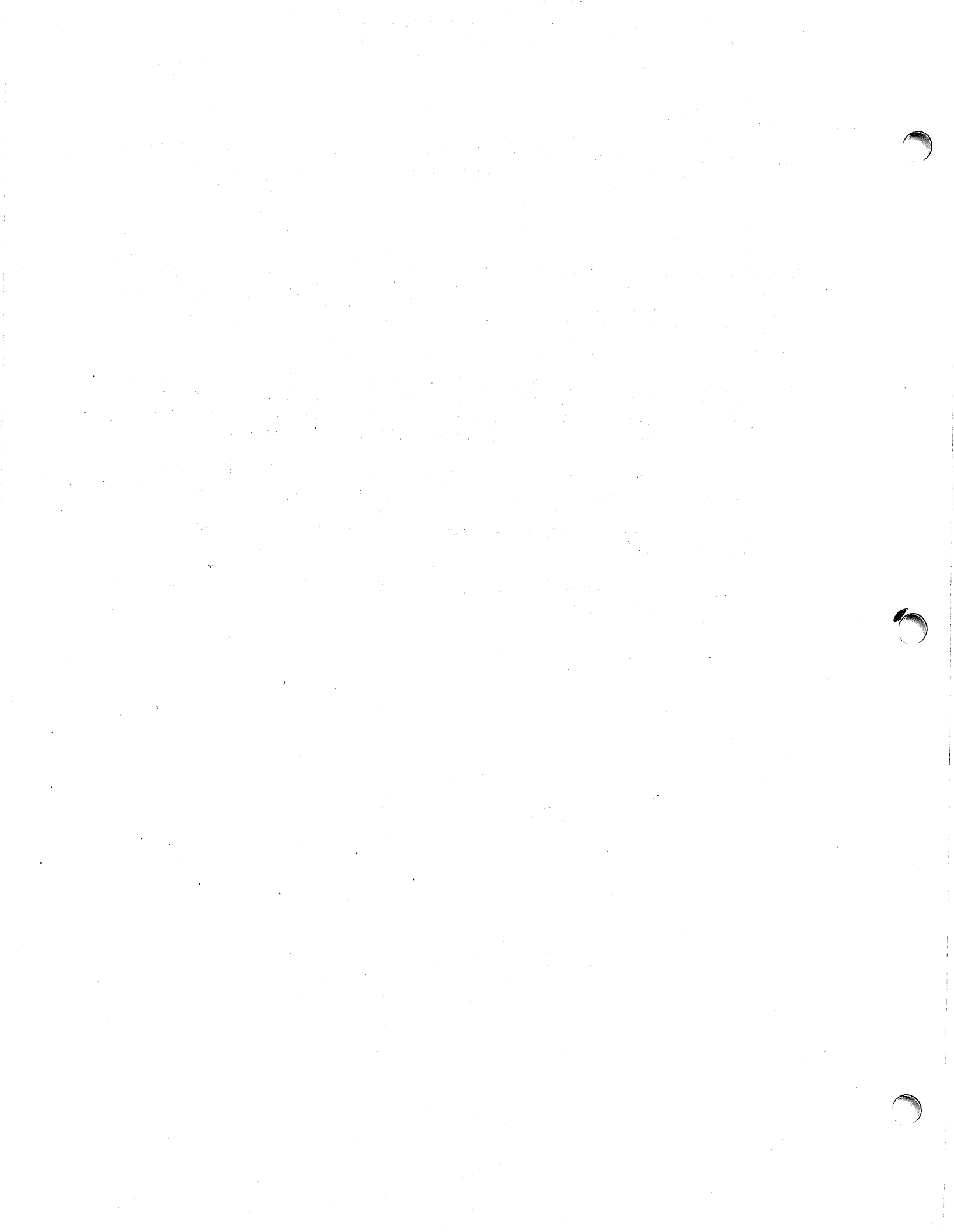

APPENDIX H
ENVELOPE FEEDER OPTION

H.1 OVERVIEW

The Envelope Feeder (refer to Figure H-1) is an electronically controlled accessory designed for use with your printer. When mounted on the printer, the Envelope Feeder automatically and continuously feeds envelopes as they are needed.

The Envelope Feeder is convenient and simple to operate. Up to 300 envelopes are placed in the easy-to-load input tray. As printing proceeds, each envelope is automatically fed through the platen, positioned, addressed, and stacked sequentially in the receiving tray. You need only load the Envelope Feeder, refill the input tray when necessary, and remove addressed envelopes from the receiving tray after printing is completed.

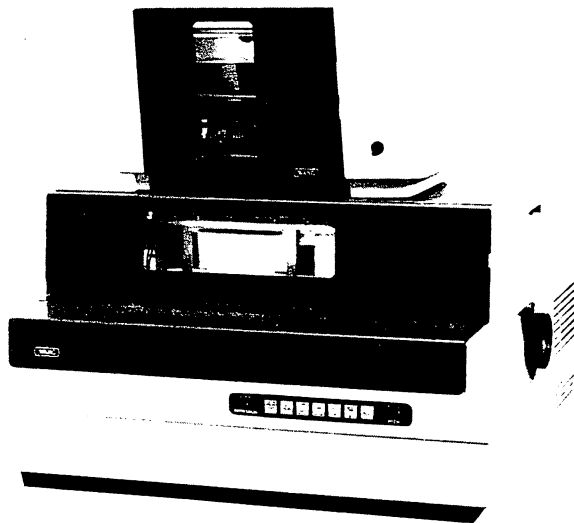

Figure H-1. Overview of Envelope Feeder

ON/OFF Button

A red ON/OFF button is located on the front of the Envelope Feeder (refer to Figure H-1). When the button is pressed, it lights, indicating that the feeder is receiving power; when the button is pressed again, the light goes out.

Input and Receiving Trays

The Envelope Feeder has two trays (refer to Figure H-2); one for blank envelopes and the other for addressed envelopes. The bottom tray is the input tray, where blank envelopes are loaded to prepare for printing. The top tray is the receiving tray, into which the addressed envelopes are fed from the printer.

Envelope Input Guide

The envelope input guide (refer to Figure H-2) is the clear plastic bar that fits on the envelope input tray. There are three sets of slots on the input tray to receive the envelope input guide. The guide is placed with the hooks down in the outer slots for #10 envelopes, in the center slots for #9 envelopes, and in the inner slots for #7 3/4 envelopes. Refer to Section H-8 for envelope sizes.

Envelope Weights

The envelope weights are used to put pressure on the envelopes to facilitate smooth feeding (refer to Figure H-2). There are two weights: the guide weight and the retainer weight. The guide weight, its curled edge pointing upwards and towards the rear of the feeder, should be placed snugly behind the envelopes in the input tray. Note that the base of the guide weight is flat. The retainer weight should be placed at the bottom of the receiving tray. A ridge on the bottom of the retainer weight fits into the track in the receiving tray.

Handles

The recessed handles on both sides of the Envelope Feeder (refer to Figure H-2) have a dual purpose. They make it easier to pick up and carry the feeder, and they also control the clamps that hold the feeder in place on the printer. When the handles are pulled up, the clamps open. When the handles are released, the clamps close. This feature enables you to pick up the feeder and place it on the printer with one movement. The same principle applies to removing the feeder from the printer: lifting it by the handles releases the clamps so you can easily remove the feeder.

Cables

Two cables are attached to the back of the Envelope Feeder. The gray cable is a 6-foot AC power cord, which plugs into an electrical outlet. The black cable is the interconnector cable, which plugs into the cable receptacle on the rear of the printer.

Silencer Hood

The silencer hood encloses the Envelope Feeder and is designed to reduce printer noise. It has a hinged door and an observation window. The door provides easy access to any envelope currently being printed. The observation window allows you to observe printer operations without opening the feeder door.

Stand

A stand is provided to hold the feeder when the feeder is not on the printer.

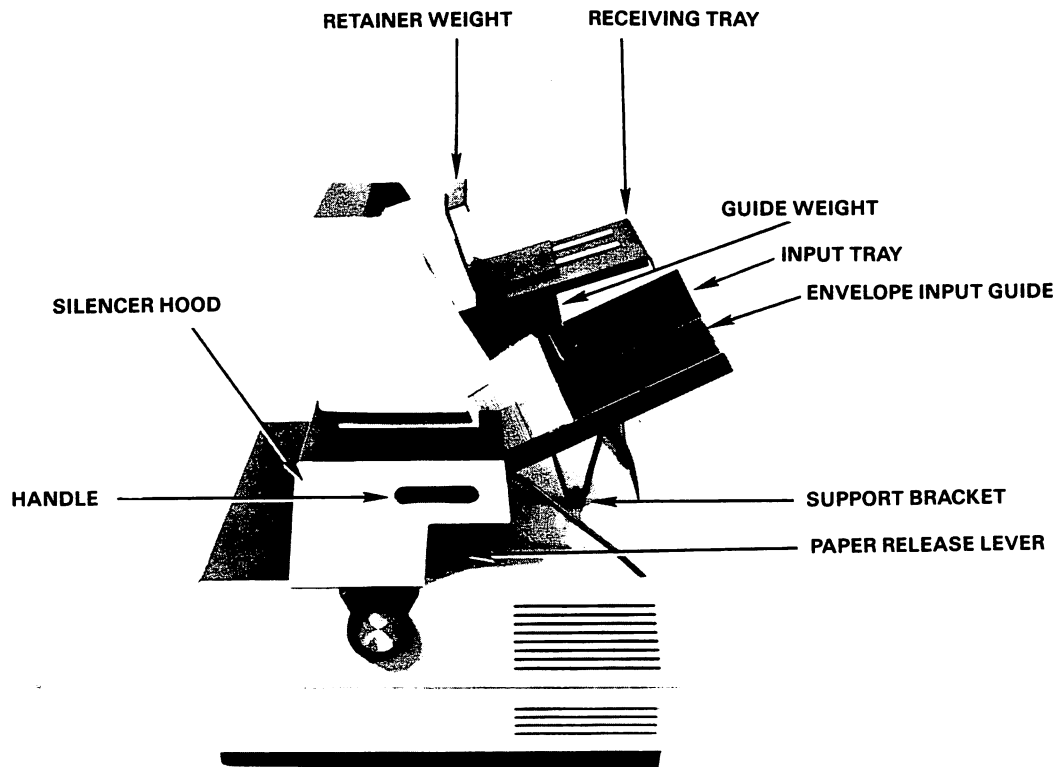

Figure H-2. Envelope Feeder

H.2 MOUNTING AND REMOVAL

The Envelope Feeder is easily mounted on and removed from your printer. The steps for mounting and removal are described in the following paragraphs.

NOTE

Be sure the printer has been properly adjusted by a Wang service representative before using the Envelope Feeder.

Mounting

Perform the following steps to install the Envelope Feeder on the printer:

1. Turn off the printer. If this is not done, a power-on reset code sequence [HEX(020DOC030F)] must be executed to set printer defaults prior to operating the feeder on the printer.
2. Remove any paper remaining in the platen.
3. Remove the paper scale and the paper rack from the printer (refer to Figure H-3). You can remove the paper scale by sliding it to the right to release it from its spring-loaded mount. The paper rack can be detached by loosening and removing the four thumbscrews that attach it to the printer.
4. Pull the paper bail forward (refer to Figure H-3). Position the black rollers to the right side of the paper bail.
5. Grasp the feeder by the handles and lift it from its stand. Lower the feeder onto the printer with the observation window facing forward and the door open. The clamps fit on the printer platen on the small bushing on the right side and on the outside groove of the platen bushing on the left side (refer to Figure H-3).
6. When the feeder is positioned properly, release the handles. The clamps automatically close when the handles are released. Close the feeder door.

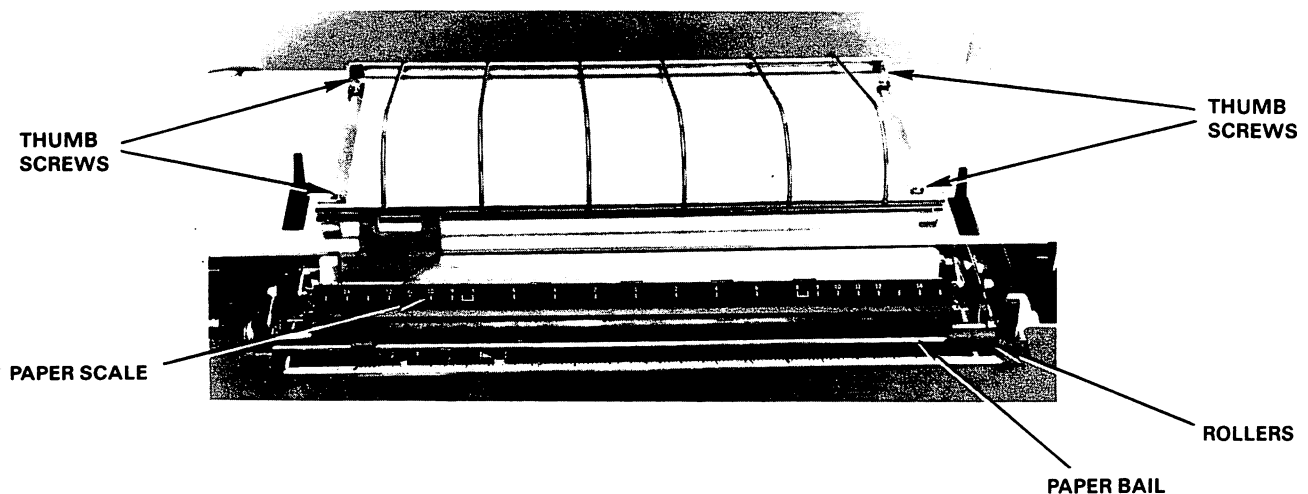

Figure H-3. Installation of the Envelope Feeder

7. Plug the feeder's AC power cord into a separate AC electrical outlet. Plug the interconnector cable on the feeder into the cable receptacle on the back of the printer.
8. Turn the feeder on by pushing in the red ON/OFF button on the front of the feeder; the button will light. You must power on the feeder before you turn the printer on.
9. Turn the printer on.
10. Set the printer's IMPRESSION (Print Intensity Adjustment) switch to M, move its paper release lever to the rear position, and set its copy control lever to Position B. Move the copy control lever to Position C for thicker envelopes.

The feeder is now ready for use.

Removal

Perform the following steps to remove the Envelope Feeder from the printer:

1. Remove the weights from the input and receiving trays.
2. Turn off the feeder by pushing in the feeder ON/OFF button; the light goes out.
3. Turn off the printer. If this is not done, a power-on reset code sequence [HEX(020D0C030F)] must be executed to set printer defaults prior to printer operation.
4. Detach the feeder's interconnector cable from the printer and unplug the electrical cable from the electrical outlet.
5. Open the silencer-hood door for a better view of the feeder clamps. Pull the feeder handles up to unlock the clamps and lift the feeder from the printer.

CAUTION

Be sure the feeder's interconnector cable and power cord are disconnected before attempting to remove the feeder from the printer.

6. Place the feeder on its stand with the support bracket resting on the bracket stand and the clamps resting on the steel rods on either side of the stand. Release the handles to secure the feeder to the stand.

NOTE

When not on the printer, the Envelope Feeder must be placed on its stand to prevent the feeder from being damaged.

H.3 LOADING AND REMOVING ENVELOPES

The Wang Envelope Feeder is designed for minimum operator intervention. Loading and removing envelopes are quick and easy processes.

Loading Envelopes

Perform the following steps to load envelopes into the feeder (refer to Figure H-4):

1. Make sure the envelope input guide is in the proper grooves for the size of the envelopes being loaded.
2. Remove the retainer weight and all envelopes from the receiving tray, and raise the receiving tray to the upright position.
3. Fan all envelopes before loading. Make sure the envelopes to be printed are neatly and loosely stacked.

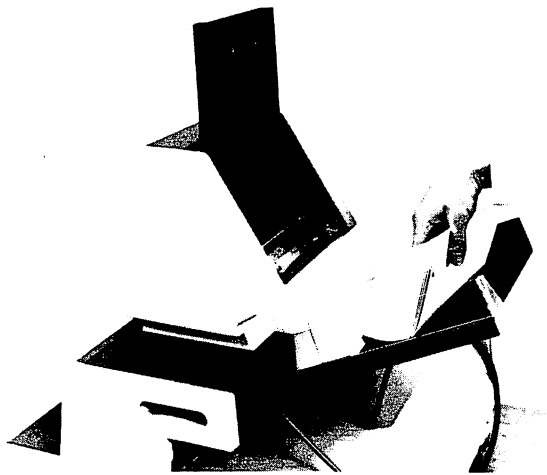

Figure H-4. Loading Envelopes

4. Place the envelopes right side up with the printing surface facing forward in the input tray. Put the guide weight firmly against the last envelope.
5. Lower the receiving tray to its former position.
6. Place the retainer weight in the track and up against the roller at the front of the receiving tray.

NOTE

When the feeder is in use, deselect the printer before adding envelopes to the input tray. This will stop printing and prevent envelope jams or feeding problems that might otherwise occur while envelopes are being added.

Do not attempt to load more than 300 envelopes into the input tray at one time.

Removing Envelopes

To remove envelopes from the feeder, remove the retainer weight from the receiving tray and then remove the addressed envelopes from the tray. To continue operation, load more envelopes as described previously.

NOTE

When the feeder is in use, deselect the printer before removing envelopes from the receiving tray. This will stop printing and prevent envelope jams or feeding problems that might otherwise occur while envelopes are being removed.

Paper Out Condition

When there are no more envelopes in the input tray, the feeder automatically lights up the printer's Change Paper indicator lamp and stops printing. When this occurs, perform the following steps:

1. Deselect the printer. Any data sent to the printer while the printer is deselected is saved in the printer buffer while new envelopes are loaded into the empty input tray.
2. Remove the addressed envelopes from the receiving tray.
3. Load more envelopes into the input tray.
4. Press the Top of Page switch on the printer control panel to load a new envelope into the platen.
5. Reselect the printer.

H.4 SWITCH-CONTROLLED OPERATIONS

While cabled to the printer, the Envelope Feeder automatically modifies the operation of the printer's Top of Page switch to enable envelope feeding. Press the Top of Page switch to clear the platen, and a new envelope will be fed to the platen.

H.5 ENVELOPE JAMS

Occasionally envelopes may jam during a Feed or Clear operation. This section discusses methods you can use to clear an envelope jam in the feeder. It should not be considered a guide to repairing the Envelope Feeder. All repairs and maintenance of the feeder must be performed by a Wang service representative to keep the feeder warranty in effect.

—WARNING—

Do not, under any circumstances, attempt to remove a jammed envelope from the feeder until the belts have stopped moving.

An envelope most commonly causes a jam when it is wrinkled, imperfectly manufactured, or incorrectly stacked in the input tray. Most jams cause the printer's Change Paper indicator lamp to light.

The procedures to remedy some possible jams are discussed in the following paragraphs.

Jam Before Printing Begins

Multiple envelopes are fed and jam behind the platen, or a single envelope is fed and jams as it rolls around the platen. If printing has not begun, the jam can be cleared with no data loss. Perform the following steps to accomplish this:

1. Deselect the printer.
2. Remove the Envelope Feeder from the printer and place it on its stand.
3. Manually remove any jammed envelopes.
4. Replace the Envelope Feeder on the printer.
5. Press the Top of Page switch to feed an envelope to the printer.
6. Reselect the printer.

When the printer is reselected, printing will resume. No data should be lost because printing was not interrupted when the jam occurred.

Jam During Printing

Multiple envelopes are fed to the printer. Printing begins, but the multiple envelope feed causes a jam in the platen, which interrupts the printing operation. Perform the following steps to clear the jam:

1. Deselect the printer, and remove all envelopes from the trays.
2. Press the Top of Page switch to clear the envelope from the platen.
3. Load envelopes into the input tray.
4. Press the Top of Page switch to feed an envelope to the platen.
5. Reselect the printer.

When this type of jam occurs, any data that has already been printed will no longer be available from the print buffer. When the printer is reselected, printing resumes with the data remaining in the buffer.

NOTE

Never pull an envelope backwards through the platen when clearing a jam. Always move the envelope through to the front of the platen.

Never reuse jammed envelopes.

H.6 PROGRAMMABLE OPERATION

You can operate the Envelope Feeder under program control through use of the printer control codes discussed in Chapter 6 of this manual. Additional hex control codes provide special functions for the feeder operator. These control codes are described in the following sections.

Clear Platen HEX(02030F)

The Clear Platen command causes an envelope currently in the platen to be cleared and stacked in the receiving tray without causing a new envelope to be fed to the platen. If the feeder does not detect an envelope behind the platen, the Clear command is ignored.

Envelope Feed HEX(0C)

The Envelope Feed command causes the envelope currently in the platen to be cleared and stacked in the receiving tray and a new envelope to be fed from the input tray. If the feeder does not detect an envelope behind the platen, the Clear command is ignored and only the Feed command is executed.

Setting Envelope Length and Height

When powered on, the Envelope Feeder sets defaults for the length and height of #10 envelopes (refer to Figure H-5). When envelopes of other sizes are used, the BASIC program must be used to reset envelope length and height.

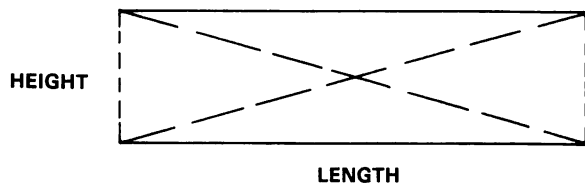

Figure H-5. Envelope Length and Height

Envelope Length

Envelope length is set by means of the SELECT PRINT statement (refer to Chapter 4 of this manual). Use this statement to select the address of the printer and specify the maximum number of characters to be printed per line. For example:

```
10 REM SET THE LENGTH FOR # 7 3/4 ENVELOPES AT 10-PITCH
20 SELECT PRINT 204 (74)
```

Table H-1 lists the maximum number of 10- and 12-pitch characters per line that can be printed on the three sizes of envelopes accommodated by the Envelope Feeder. The values listed in the right column are the maximum values that can be used as XXXX values in the Move commands and Set Left Margin commands discussed in Section 6.2 of this manual.

Table H-1. Envelope Length Specifications

Envelope Size	Characters		Right Margin Limit in 1/60-Inch Increments (XXXX)
	10-pitch	12-pitch	
#7 3/4	74	94	01EE hex
#9	88	105	0240 hex
#10	94	113	0261 hex

Envelope Height

The Set Envelope Height command, HEX(020C0102YYYY0F), sets the bottom margin for all printing operations on each envelope. It thus enables you to specify the height of the printing area of each envelope. Whenever the bottom margin of the printing area is reached, an automatic envelope feed is executed, clearing the current envelope and feeding a new envelope from the input tray. Printing automatically continues on the newly fed envelope.

When an envelope is fed behind the platen, the top margin is set at approximately 1.5 inches from the top edge. The height of the print area is measured from this point to the bottom edge of the envelope. The YYYY sequence of the Set Envelope Height command is a positive hexadecimal value representing the end of the available print area. For example:

```
10 REM SET THE HEIGHT FOR #9 ENVELOPES
20 PRINT HEX(020C010200700F)
```

As a result of this statement, when the printer reaches the bottom line of the envelope, it ejects the envelope to the receiving tray, and the feeder feeds a new envelope to the printer.

NOTE

Whenever changing to a new envelope size, you should execute a Set Envelope Height command. (The YYYY values to be used are supplied in Table H-2.)

Table H-2 lists the hex value of the maximum number of 1/48-inch incremental movements (YYYY) that can be made vertically on envelopes of the three sizes accommodated by the Envelope Feeder.

Table H-2. Envelope Height Specifications

Envelope Size	Number of Print Lines Available	Envelope Height Limit in 1/48-Inch Increments (YYYY)
#7 3/4	14	0070 hex
#9	14	0070 hex
#10	15	0078 hex

H.7 GENERAL CARE AND MAINTENANCE

This section lists some procedures that should be strictly followed to keep the Envelope Feeder running smoothly.

Things to Do

1. Always fan envelopes before loading.
2. Remove old envelopes from the input tray and restack them when adding new envelopes. Refan envelopes before reloading the input tray.
3. Be aware that changes in humidity can affect envelopes. If envelopes have been stored in a humid area, let them stand for 24 hours in a room of normal humidity before you put them through the feeder.
4. Remember to unplug the feeder and detach the interconnector cable before removing the feeder from the printer, unless the feeder is temporarily removed to clear an envelope jam.
5. Place feeder in stand when it is not in use.

Things to Avoid

1. Do not attempt to use envelope sizes other than #7 3/4, #9, and #10 in the feeder.
2. Do not mix different sizes of envelopes.
3. Do not use wrinkled, curled, or previously jammed envelopes.
4. Do not attempt to feed used or previously stuffed envelopes into the feeder.
5. Do not overload. Do not attempt to load more than 300 envelopes into the feeder at one time.
6. Never reach into the feeder when it is operating.
7. Do not load or unload envelopes while the feeder is operating.
8. Do not leave envelopes in the feeder overnight.

H.8 ENVELOPE FEEDER SPECIFICATIONS

Models

<u>Model</u>	<u>Envelope Sizes</u>
EF-11	#7 3/4, #9, #10
EF-12	#7 3/4, #9, #10
EF-13	Minimum: 3.875 in. x 7.5 in. (98.4 mm x 190.5 mm) Maximum: 4.250 in. x 8.875 in. (108.0 mm x 225.4 mm)

Physical Dimensions (All Models)

Height	14.0 in. (36.1 cm)
Depth	17.0 in. (42.4 cm)
Width	23.5 in. (58.5 cm)

Weight

28.5 lb (13.0 kg)

Envelope Sizes

<u>Type</u>	<u>Width/Length</u>
#7 3/4	3.875 in. x 7.5 in. (\pm 0.03125 in.) (98.4 mm x 190.5 mm)
#9	3.875 in. x 8.875 in. (\pm 0.03125 in.) (98.4 mm x 225.4 mm)
#10	4.125 in. x 9.5 in. (\pm 0.03125 in.) (104.8 mm x 241.3 mm)

Warpage of new envelopes shall not exceed 0.50 inch. Self-sealing envelopes cannot be used with the Envelope Feeder.

Capacity

Input Tray	300 envelopes
Receiving Tray	300 envelopes

Paper Grade

20 lb (\pm 1.10 lb)	0 to 50% rag content
22 lb (\pm 1.10 lb)	0 to 50% rag content
24 lb (\pm 1.10 lb)	0 to 50% rag content

Switches and Indicators

Power button that lights

Installation

Feeder latches to platen and rests on rear of cover.
Electric cable connects feeder to printer.
Power cable connects feeder to conventional office electrical outlet.

Power Requirements

<u>Model</u>	<u>Power</u>
EF-11	115 VAC \pm 10 %, 60 Hz \pm 1 Hz, 50 W
EF-12	230 VAC \pm 10 %, 50 Hz \pm 1 Hz, 50 W
EF-13	230 VAC \pm 10 %, 50 Hz \pm 1 Hz, 50 W

Fuse

1.0 amp (SB)

Cable

6-ft AC power cord
Interconnector cable to printer

Operating Environment

50° to 80°F (10° to 27°C)
30% to 55% relative humidity, noncondensing (recommended)
20% to 70% relative humidity, noncondensing (allowable)

NOTE

Envelope Feeder operation may not meet specifications if envelopes are adversely affected by environmental conditions.

Storage Clearance

Height	20.0 in. (50.8 cm)
Depth	20.0 in. (50.8 cm)
Width	30.0 in. (76.2 cm)

PREVENTIVE MAINTENANCE

It is recommended that your equipment be serviced quarterly. A Maintenance Agreement is available to assure this servicing automatically. If no Maintenance Agreement is acquired, any servicing must be arranged by the customer. A Maintenance Agreement protects your investment and offers the following benefits:

Preventive Maintenance: Your equipment is inspected quarterly for worn parts, lubricated, cleaned, and updated with engineering changes, if any. Preventive maintenance minimizes 'downtime' by anticipating repairs before they are necessary.

Fixed Annual Cost: When you buy a Maintenance Agreement, you issue only one purchase order for service for an entire year and receive one annual billing; more frequent billing can be obtained, if desired.

Further information regarding Maintenance Agreements can be acquired from your local Sales Service Office.

NOTE

Wang Laboratories, Inc., does not guarantee or honor Maintenance Agreements for any equipment modified by the user. Damage to equipment incurred as a result of such modification becomes the financial responsibility of the user.

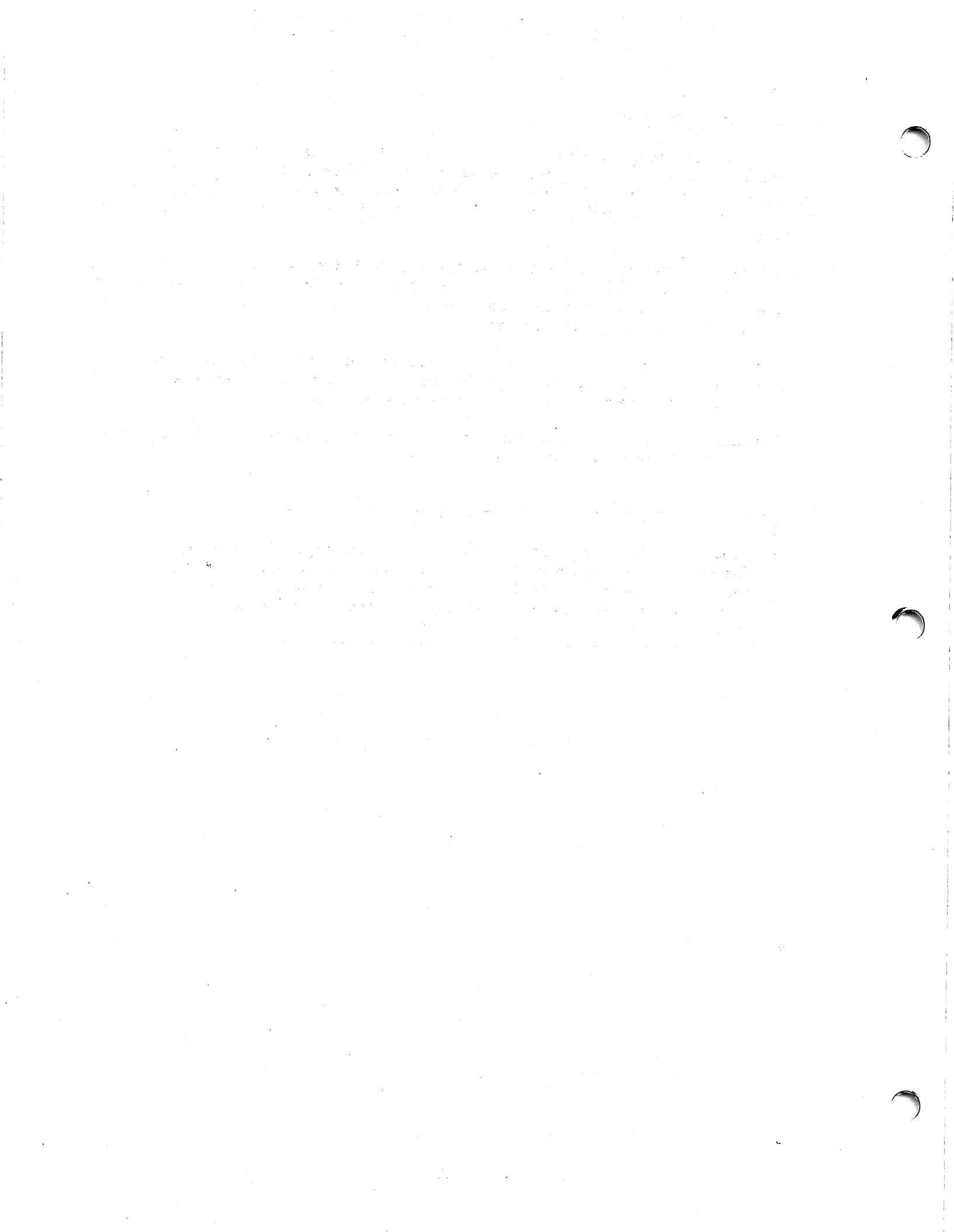

INDEX

Absolute Move	6-4
Automatic Line Feed	6-2
Backspace	6-2
Backwards Linefeed	6-7
Binary Notation	C-1
BIN Statement (BASIC)	C-3
BIN Statement (BASIC-2)	C-4
Buffer	6-1
Carriage Return Code	6-3
Carriage Width	A-1
Changing the Print Wheel	3-6
Changing the Ribbon Cartridge	3-2 to 3-5
Character Codes	4-1, 4-2
Character Set	B-1
Cleaning the Printer	3-10
Combined Parameters	4-8
Comma with PRINT Statement	5-1
Control Codes	6-1 to 6-19
Control Panel	2-1 to 2-3
Change Daisy Indicator	2-2
Change Paper Indicator	2-2
Change Ribbon Indicator	2-3
Low/High Impression Buttons	2-3
Malfunction Indicator	2-3
On/Off Switch	2-1
Select Button	2-2
Test Button	2-3
Top of Page Button	2-2
Decimal/Binary Conversion	C-1, C-2
Deselection	6-4
Deselecting the Printer	4-9
Device Address	4-2
Device Type	4-2, 4-3
Device Type 0	4-2
Device Type 2	4-2, 4-3
Device Type 4	4-3
Diagnostic Error Indicators	2-4, 2-5
Diagnostics Test	2-3
Direct Access Vertical Format	G-1
Double-Spaced Output	4-2
Down Load Font	6-18
Element Separators in PRINT Statement	5-1, 5-2

Envelope Feeder	H-1
Controls	H-2, H-7
Envelope Jams	H-8
Envelope Specifications	H-10
Loading Envelopes	H-6
Maintenance	H-11
Mounting	H-4
Programmable Operations	H-9
Removal	H-6
Error Codes	2-4, 2-5
Form Alignment	3-7
Formatting Output (HEX Codes)	6-1 to 6-19
Forms Impression Control	2-3
Forms Thickness Control	2-7
Hex Function	6-1
Hexadecimal Codes	6-1, B-1
HEX(OD) in Alpha Variable	D-2
HEXPRINT Statement	4-7
Home Position	6-8
Incremental Spacing	6-10, 6-11
Initializing a Form	6-7
Inspection	1-2
Installation	1-2
Line Feed (Backwards)	6-7
Line Feed Control Code	6-4, 6-10
Line Feed (Partial)	6-19
Line Feed Suppression	6-2
Line Length	4-4
Load DAVFU	G-1, G-3
Malfunction Indicator	2-3
Multipart Forms	A-1
ON/OFF Switch	2-1
Packed Format	5-2
Paper Insertion	3-7, 3-9
Paper Out Indicator	2-2
Paper Release Lever	2-6
Paper Specifications	A-1
Pin-Feed Gates	3-8, 3-9
Pitch Selection	6-19
Platen Knob	2-6
Power Indicator	2-1
Power-On	2-1
Power-On Reset Code Sequence	6-6
Print Head (Daisy)	3-6, 3-7
PRINT Statement	5-1
PRINTUSING Statement	5-4

Reporting a Printer Problem	3-10
Reverse Index	6-7
Ribbon Cartridge Replacement	3-3
Ribbon Guide	3-4
Ribbon Out	2-3
Select Character Font	6-18
SELECT CO Statement	4-8
SELECT PRINT Statement	4-6, 4-7
SELECT Statement	4-1, 4-2
SELECT Switch	2-2
Semicolon (Line Suppression)	5-3
Set Form Length	6-7
Set Left Margin	6-8, 6-9
Set Line Feed Spacing	6-10, 6-11
Specifications	1-2, A-1
Speed	1-1, A-1
Suppressing Carriage Return	5-3
TAB Function	5-5
Test Switches	2-6
Top-of-Form	2-2, 6-15
Twin Sheet Feeder	F-1 to F-9
2's Complement	C-2
Underscore	6-16
Unit Address	4-4
Unpacking	1-2
Vertical Format Control Utility	G-1
Vertical Skip	6-7, 6-10, 6-17
Vertical Tab	6-17, B-1
Zoned Format	5-1
@2273VFU	G-1

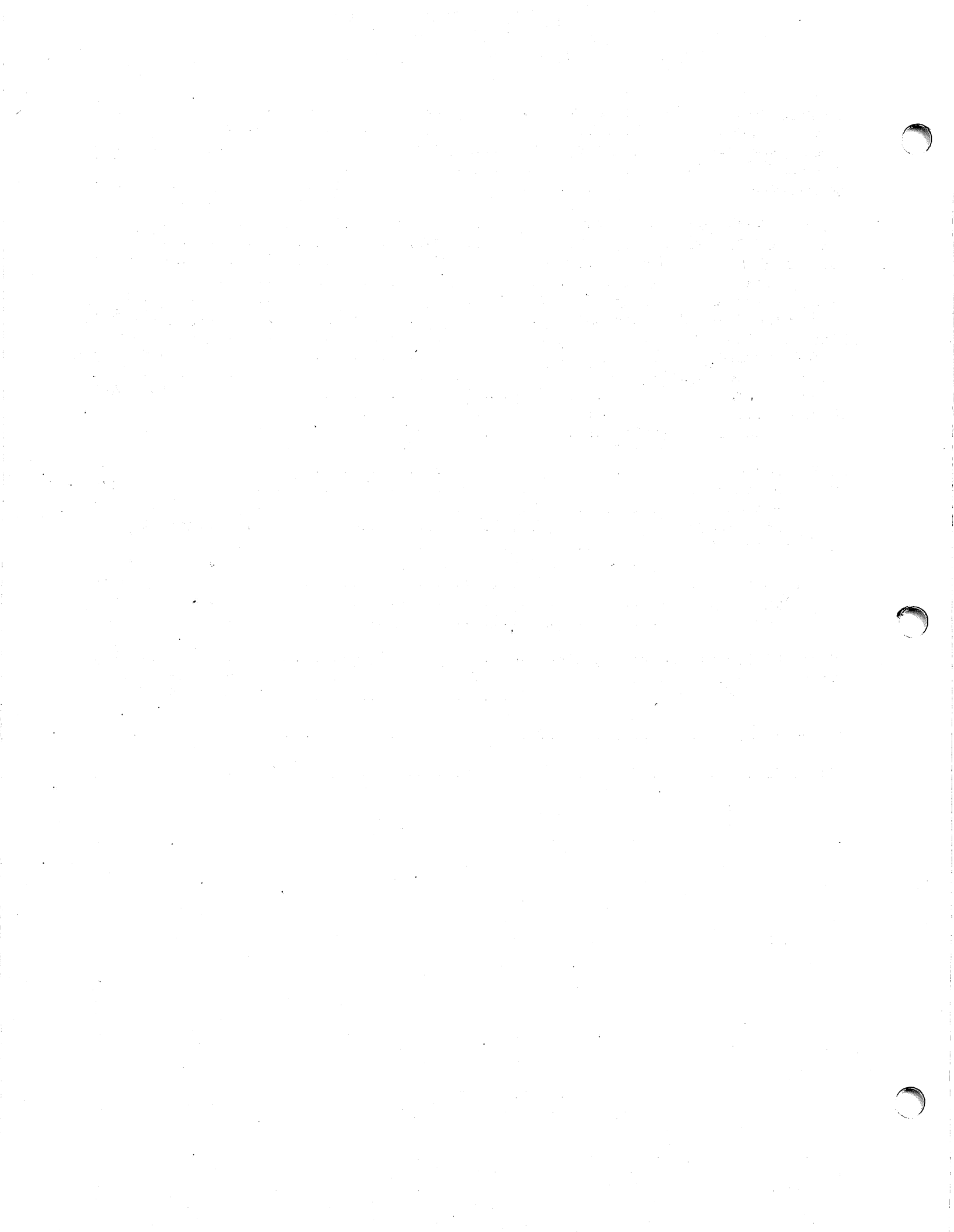



Customer Comment Form

Publications Number 700-7629

Title 2200 DW/22-20 DAISY PRINTER USER MANUAL

Help Us Help You . . .

We've worked hard to make this document useful, readable, and technically accurate. Did we succeed? Only you can tell us! Your comments and suggestions will help us improve our technical communications. Please take a few minutes to let us know how you feel.

How did you receive this publication?

Support or Sales Rep

Wang Supplies Division

From another user

Enclosed with equipment

Don't know

Other _____

How did you use this Publication?

Introduction to the subject

Classroom text (student)

Classroom text (teacher)

Self-study text

Aid to advanced knowledge

Guide to operating instructions

As a reference manual

Other _____

Please rate the quality of this publication in each of the following areas.

	EXCELLENT	GOOD	FAIR	POOR	VERY POOR
Technical Accuracy — Does the system work the way the manual says it does?	<input type="checkbox"/>	<input type="checkbox"/>	<input type="checkbox"/>	<input type="checkbox"/>	<input type="checkbox"/>
Readability — Is the manual easy to read and understand?	<input type="checkbox"/>	<input type="checkbox"/>	<input type="checkbox"/>	<input type="checkbox"/>	<input type="checkbox"/>
Clarity — Are the instructions easy to follow?	<input type="checkbox"/>	<input type="checkbox"/>	<input type="checkbox"/>	<input type="checkbox"/>	<input type="checkbox"/>
Examples — Were they helpful, realistic? Were there enough of them?	<input type="checkbox"/>	<input type="checkbox"/>	<input type="checkbox"/>	<input type="checkbox"/>	<input type="checkbox"/>
Organization — Was it logical? Was it easy to find what you needed to know?	<input type="checkbox"/>	<input type="checkbox"/>	<input type="checkbox"/>	<input type="checkbox"/>	<input type="checkbox"/>
Illustrations — Were they clear and useful?	<input type="checkbox"/>	<input type="checkbox"/>	<input type="checkbox"/>	<input type="checkbox"/>	<input type="checkbox"/>
Physical Attractiveness — What did you think of the printing, binding, etc?	<input type="checkbox"/>	<input type="checkbox"/>	<input type="checkbox"/>	<input type="checkbox"/>	<input type="checkbox"/>

Were there any terms or concepts that were not defined properly? Y N If so, what were they? _____

After reading this document do you feel that you will be able to operate the equipment/software? Yes No Yes, with practice

What errors or faults did you find in the manual? (Please include page numbers) _____

Do you have any other comments or suggestions? _____

Name _____ Street _____

Title _____ City _____

Dept/Mail Stop _____ State/Country _____

Company _____ Zip Code _____ Telephone _____

Thank you for your help.

WANG

Fold



**NO POSTAGE
NECESSARY
IF MAILED
IN THE
UNITED STATES**

BUSINESS REPLY CARD
FIRST CLASS PERMIT NO. 16 LOWELL, MA

POSTAGE WILL BE PAID BY ADDRESSEE

**WANG LABORATORIES, INC.
CHARLES T. PEERS, JR., MAIL STOP 1363
ONE INDUSTRIAL AVENUE
LOWELL, MASSACHUSETTS 01851**

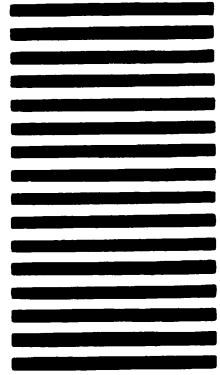

Fold

Cut along dotted line.



The completed order form should be mailed to:

WANG LABORATORIES, INC.
Supplies Division
51 Middlesex St.
No. Chelmsford MA 01863

To Order by Phone, Call:

(800)225-0234

From Mass., Hawaii, and Alaska

(617)256-1400

TELEX 951-743

Order Form for Wang Manuals and Documentation

① Customer Number (If Known)				
② Bill To:			Ship To:	
_____			_____	
_____			_____	
_____			_____	
③ Customer Contact:			④ Date	Purchase Order Number
() () _____			_____	_____
Phone _____			Name _____	
⑤ Taxable	⑥ Tax Exempt Number	⑦ Credit This Order to		
Yes <input type="checkbox"/>		A Wang Salesperson _____		
No <input type="checkbox"/>		Please Complete Salesperson's Name _____ Employee No. _____ RDB No. _____		
⑧ Document Number	Description	Quantity	⑨ Unit Price	Total Price
⑩ _____ Authorized Signature _____ Date _____ <input type="checkbox"/> Check this box if you would like a free copy of the Corporate Publications Literature Catalog (700-5294)			Sub Total	
			Less Any Applicable Discount	
			Sub Total	
			Local/State Tax	
			Total Amount	

Ordering Instructions

1. If you have purchased supplies from Wang before, and know your Customer Number, please write it here.
2. Provide appropriate Billing Address and Shipping Address.
3. Please provide a phone number and name, should it be necessary for WANG to contact you about your order.
4. Your purchase order number and date.
5. Show whether order is taxable or not.
6. If tax exempt, please provide your exemption number.
7. If you wish credit for this order to be given to a WANG salesperson, please complete.
8. Show part numbers, description and quantity for each product ordered.
9. Pricing extensions and totaling can be completed at your option; Wang will refigure these prices and add freight on your invoice.
10. Signature of authorized buyer and date.

Wang Supplies Division Terms and Conditions

1. **TAXES** — Prices are exclusive of all sales, use, and like taxes.
2. **DELIVERY** — Delivery will be F.O.B. Wang's plant. Customer will be billed for freight charges; and unless customer specifies otherwise, all shipments will go best way surface as determined by Wang. Wang shall not assume any liability in connection with the shipment nor shall the carrier be construed to be an agent of Wang. If the customer requests that Wang arrange for insurance the customer will be billed for the insurance charges.
3. **PAYMENT** — Terms are net 30 days from date of invoice. Unless otherwise stated by customer, partial shipments will generate partial invoices.
4. **PRICES** — The prices shown are subject to change without notice. Individual document prices may be found in the Corporate Publications Literature Catalog (700-5294)
5. **LIMITATION OF LIABILITY** — In no event shall Wang be liable for loss of data or for special, incidental or consequential damages in connection with or arising out of the use of or information contained in any manuals or documentation furnished hereunder

WANG

Fold



**NO POSTAGE
NECESSARY
IF MAILED
IN THE
UNITED STATES**

BUSINESS REPLY CARD
FIRST CLASS PERMIT NO. 16 NO. CHELMSFORD, MA.

POSTAGE WILL BE PAID BY ADDRESSEE

**WANG LABORATORIES, INC.
Supplies Division
c/o Order Entry Dept.
M/S 5511
51 Middlesex St.
No. Chelmsford, MA 01863**



Fold

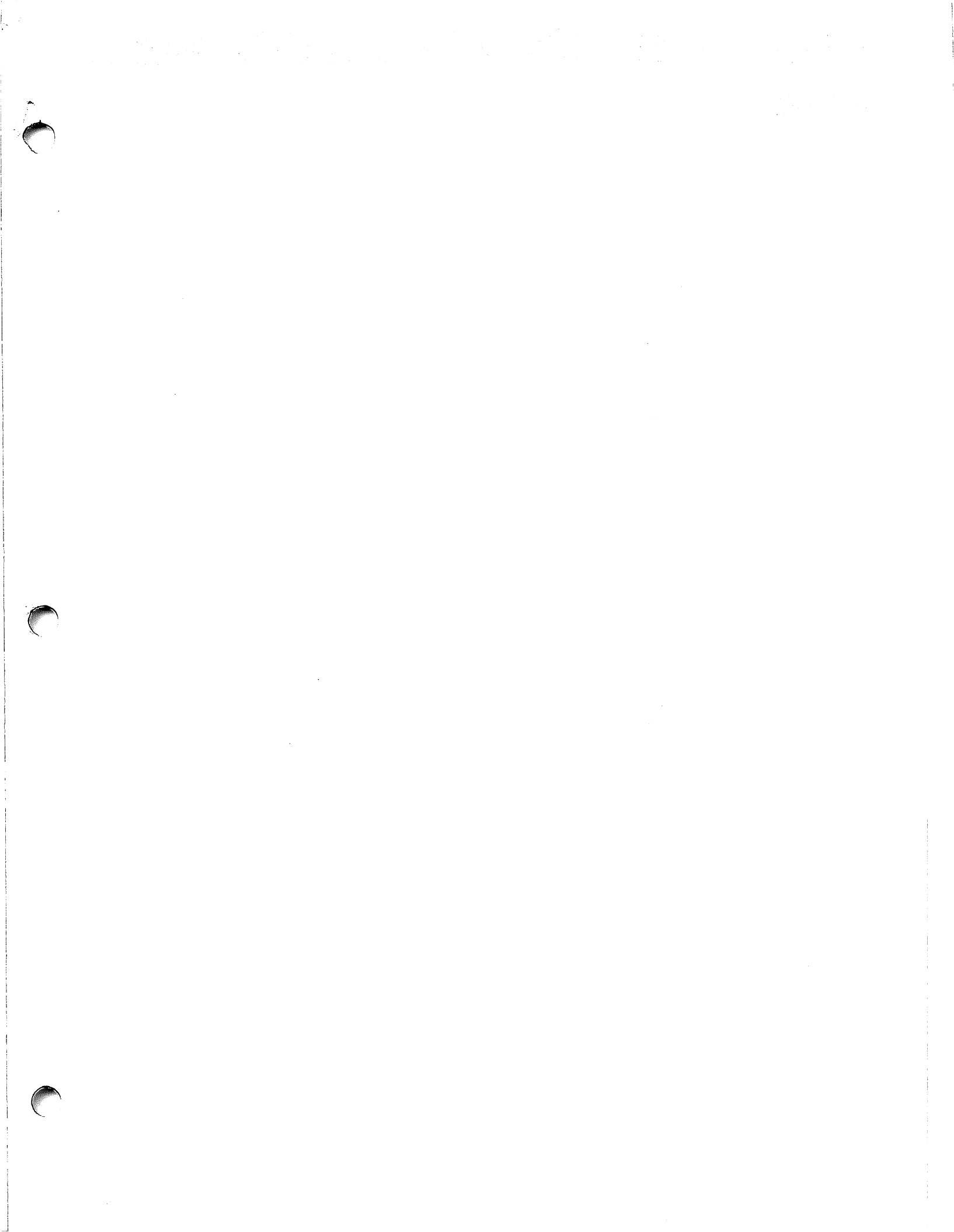



WANG

ONE INDUSTRIAL AVENUE
LOWELL, MASSACHUSETTS 01851
TEL. (617) 459-5000
TWX 710-343-6769, TELEX 94-7421