

WANG

# Envelope Feeder User Manual





# **2200 Envelope Feeder User Manual**

**1st Edition May 1, 1981  
Copyright © Wang Laboratories, Inc. 1981  
700-6833**

**WANG** LABORATORIES, INC.  
ONE INDUSTRIAL AVENUE, LOWELL, MASSACHUSETTS 01851, TEL. (617) 459-5000, TWX 710 343-6769, TELEX 94-7421

## **Disclaimer of Warranties and Limitation of Liabilities**

The staff of Wang Laboratories, Inc., has taken due care in preparing this manual; however, nothing contained herein modifies or alters in any way the standard terms and conditions of the Wang purchase agreement, lease agreement, or rental agreement by which this equipment was acquired, nor increases in any way Wang's liability to the customer. In no event shall Wang Laboratories, Inc., or its subsidiaries be liable for incidental or consequential damages in connection with or arising from the use of this manual or any programs contained herein.

**WANG**

LABORATORIES, INC.

---

ONE INDUSTRIAL AVENUE, LOWELL, MASSACHUSETTS 01851, TEL. (617) 459-5000, TWX 710 343-6769, TELEX 94-7421

## PREFACE

This manual describes the components and operation of the Wang Envelope Feeder, designed for the Wang 2200 product line. The Envelope Feeder is compatible with the Wang Model 2281W Printer/Plotter.

Chapter 1 briefly describes the feeder and its individual components and functions; Chapter 2 contains instructions on mounting, loading, and operating of the feeder; Chapter 3 discusses the programmable operation of the feeder when it is used to address envelopes; and Chapter 4 contains general information on the care and maintenance of the feeder.

It is recommended that this manual be read in its entirety before the Envelope Feeder is used.

For instructions on the operation of the printer, refer to the *Model 2281W Printer/Plotter User Manual* (700-5744A).

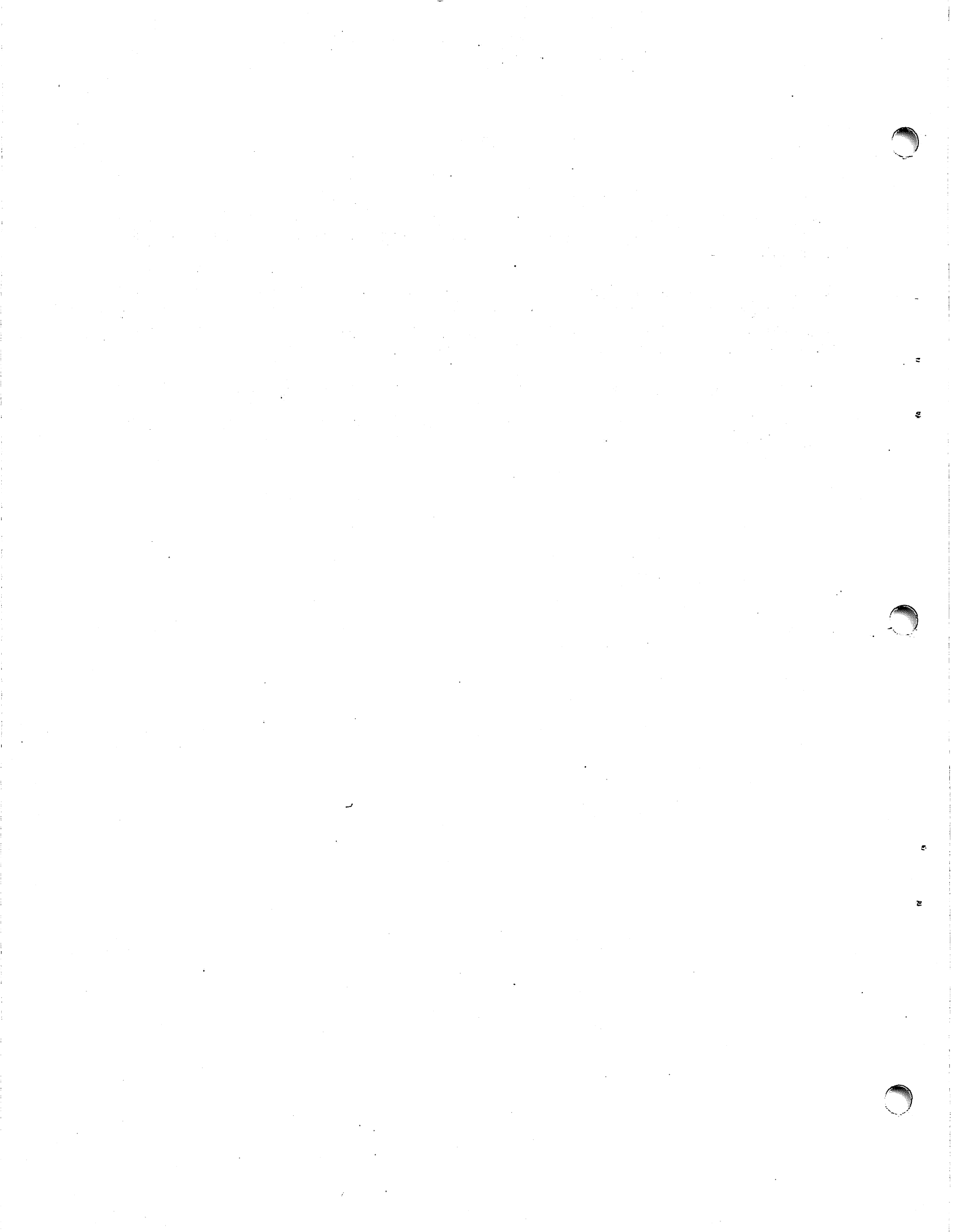

# CONTENTS

<b>CHAPTER 1</b>	<b>FEEDER COMPONENTS</b>	
1.1	Overview .....	1-1
1.2	ON/OFF Button .....	1-1
1.3	Input and Receiving Trays .....	1-1
1.4	Envelope Input Guide .....	1-2
1.5	Envelope Weights .....	1-2
1.6	Handles .....	1-2
1.7	Cables .....	1-2
1.8	Silencer Hood .....	1-2
1.9	Stand .....	1-2
<b>CHAPTER 2</b>	<b>FEEDER OPERATION</b>	
2.1	Mounting and Removal .....	2-1
	Mounting .....	2-1
	Removal .....	2-2
2.2	Loading and Removing Envelopes .....	2-3
	Loading Envelopes .....	2-3
	Removing Envelopes .....	2-4
	Paper Out Condition .....	2-4
2.3	Switch-Controlled Operations .....	2-5
2.4	Envelope Jams .....	2-5
	Jam Before Printing Begins .....	2-6
	Jam During Printing .....	2-6
<b>CHAPTER 3</b>	<b>PROGRAMMABLE OPERATION</b>	
3.1	Introduction .....	3-1
3.2	Clear Platen: HEX(02030F) .....	3-1
3.3	Envelope Feed: HEX(0C) .....	3-1
3.4	Setting Envelope Length and Height .....	3-1
	Envelope Length .....	3-2
	Envelope Height .....	3-2
<b>CHAPTER 4</b>	<b>GENERAL CARE AND MAINTENANCE</b>	
4.1	Things to Do .....	4-1
4.2	Things to Avoid .....	4-1
<b>Appendix A</b>	<b>Envelope Feeder Specifications .....</b>	<b>A-1</b>
<b>INDEX</b> .....		<b>INDEX-1</b>

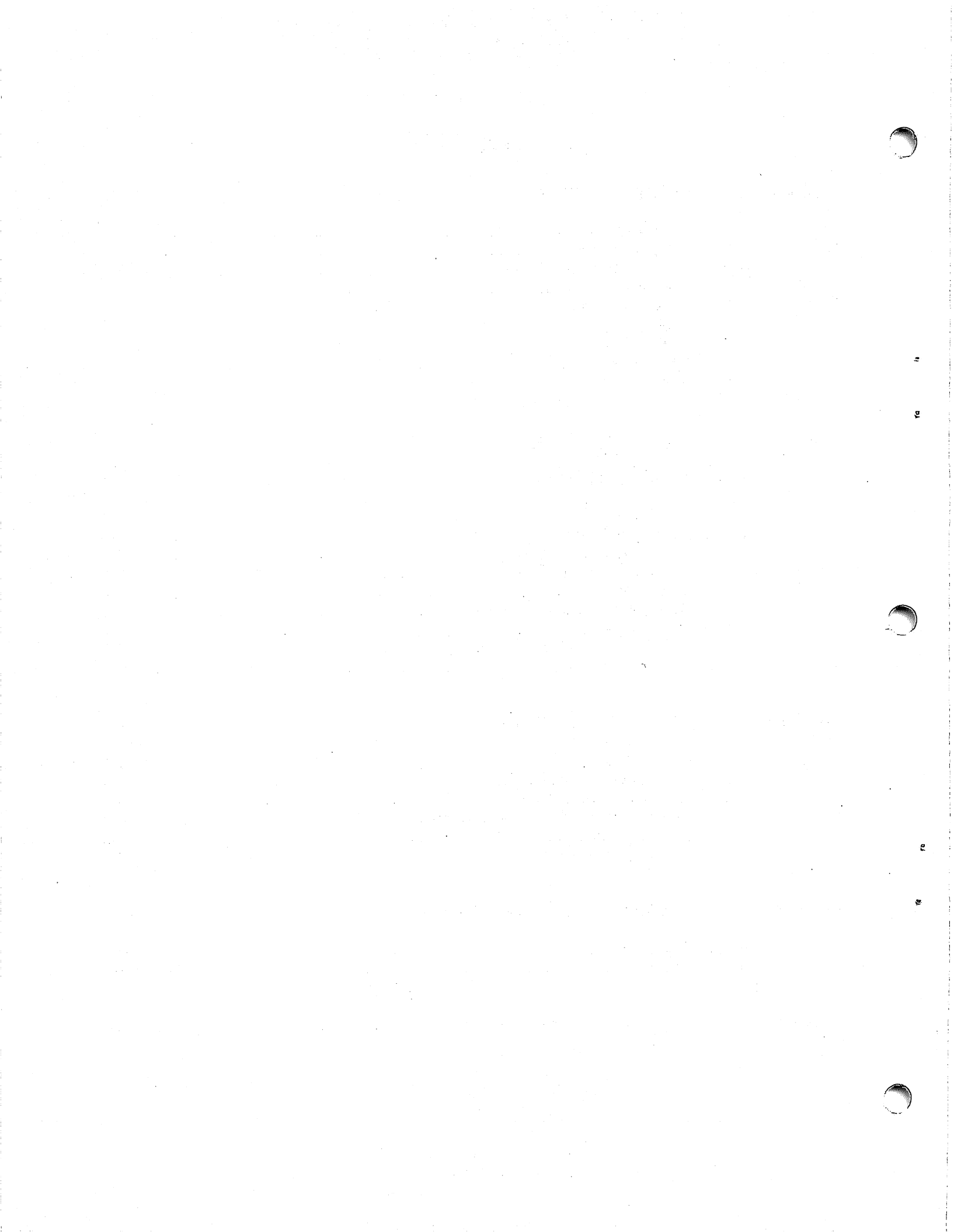



## FIGURES

Figure 1-1	Overview of Envelope Feeder .....	1-1
Figure 1-2	Envelope Feeder .....	1-3
Figure 2-1	Installation of the Envelope Feeder .....	2-2
Figure 2-2	Loading Envelopes .....	2-3
Figure 2-3	Model 2281W Front Panel Inserts for Envelope Feeder .....	2-5
Figure 3-1	Envelope Length and Height .....	3-1

## TABLES

Table 3-1	Envelope Length Specifications .....	3-2
Table 3-2	Envelope Height Specifications .....	3-3

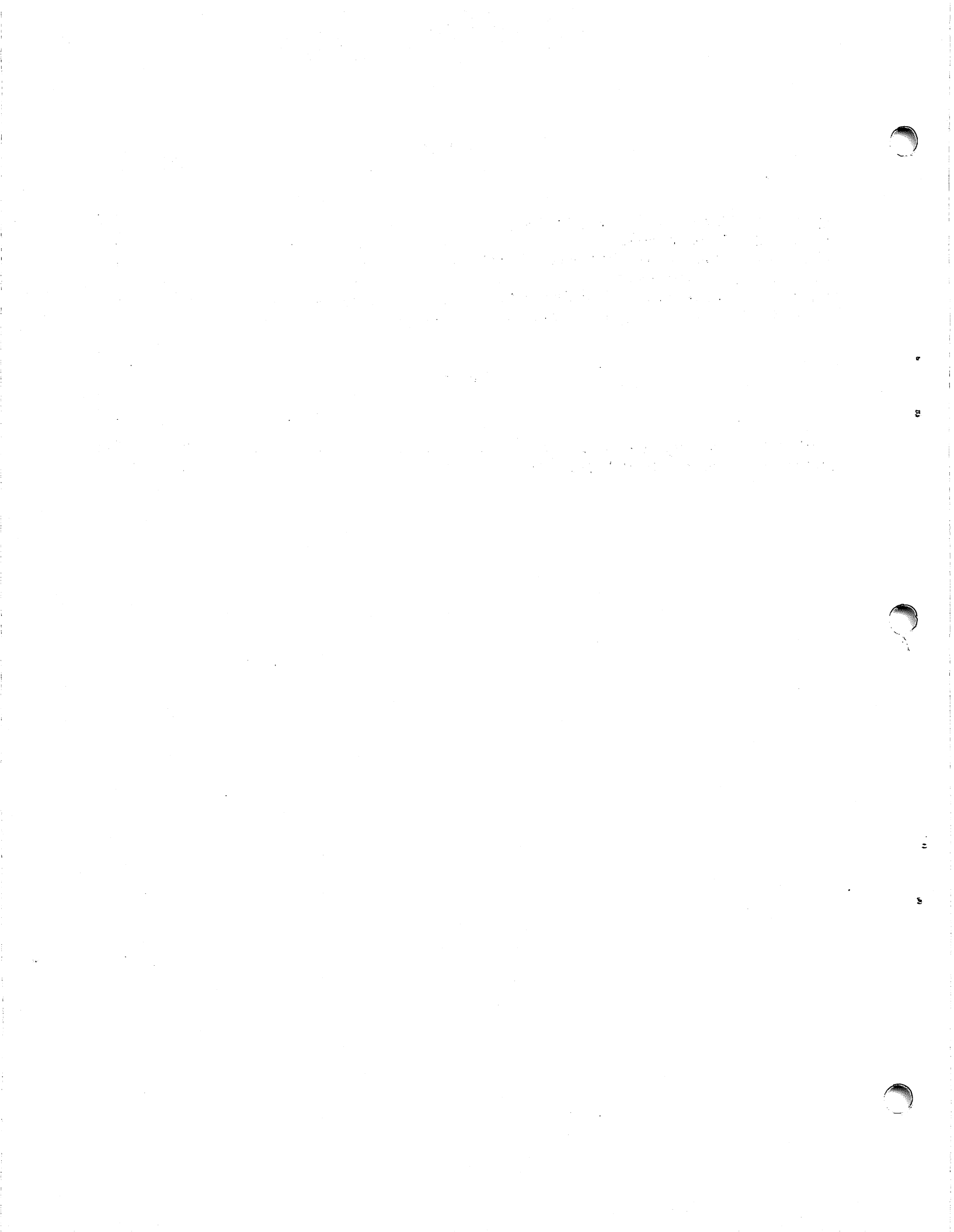

# CHAPTER 1

## FEEDER COMPONENTS

### 1.1 OVERVIEW

The Envelope Feeder (refer to Figure 1-1) is an electronically controlled accessory designed to be used with the Wang Model 2281W Printer/Plotter. When mounted on the printer, the Envelope Feeder automatically and continuously feeds envelopes as they are needed.

The Envelope Feeder is convenient and simple to operate. Up to 300 envelopes are placed in the easy-to-load input tray. As printing proceeds, each envelope is automatically fed through the platen, positioned, addressed, and stacked sequentially in the receiving tray. An operator need only load the Envelope Feeder, refill the input tray when necessary, and remove addressed envelopes from the receiving tray after printing is completed.



Figure 1-1. Overview of Envelope Feeder

### 1.2 ON/OFF BUTTON

A red ON/OFF button is located on the front of the Envelope Feeder (refer to Figure 1-1). When the button is pressed, it illuminates, indicating that the feeder is receiving power; when the button is pressed again, it is extinguished.

### 1.3 INPUT AND RECEIVING TRAYS

The Envelope Feeder has two trays (refer to Figure 1-2), one for blank envelopes and the other for addressed envelopes. The bottom tray is the input tray, into which blank envelopes are loaded in preparation for printing. The top tray is the receiving tray, into which the addressed envelopes are fed from the printer.

## **1.4 ENVELOPE INPUT GUIDE**

The clear plastic bar that fits on the envelope input tray is called the envelope input guide (refer to Figure 1-2). There are three sets of slots on the input tray to receive the envelope input guide. The guide is placed with the hooks down in the outer slots for #10 envelopes, in the center slots for #9 envelopes, and in the inner slots for #7 3/4 envelopes. Refer to Appendix A for envelope sizes.

## **1.5 ENVELOPE WEIGHTS**

The envelope weights are used to put pressure on the envelopes to facilitate smooth feeding (refer to Figure 1-2). There are two weights: the guide weight and the retainer weight. The guide weight, its curled edge pointing upwards and towards the rear of the feeder, should be placed snugly behind the envelopes in the input tray. Note that the base of the guide weight is flat. The retainer weight should be placed at the bottom of the receiving tray. A ridge on the bottom of the retainer weight fits into the track in the receiving tray.

## **1.6 HANDLES**

The recessed handles on both sides of the Envelope Feeder (refer to Figure 1-2) have a dual purpose. They make it easier to pick up and carry the feeder, and they also control the clamps that hold the feeder in place on the printer. When the handles are pulled up, the clamps open. When the handles are released, the clamps close. This feature enables the operator to pick up the feeder and place it on the printer with one movement. The same principle applies to removing the feeder from the printer: lifting it by the handles releases the clamps and the feeder can be easily removed.

## **1.7 CABLES**

Two cables are attached to the back of the Envelope Feeder. The gray cable is a 6-foot AC power cord and plugs into an electrical outlet. The black cable is the interconnector cable and plugs into the cable receptacle on the rear of the printer.

## **1.8 SILENCER HOOD**

The silencer hood encloses the Envelope Feeder and has been designed to reduce printer noise. It has a hinged door and an observation window. The door provides easy access to any envelope currently being printed. The observation window allows the user to observe printer operations without opening the feeder door.

## **1.9 STAND**

A stand is provided to hold the feeder when the feeder is not on the printer.

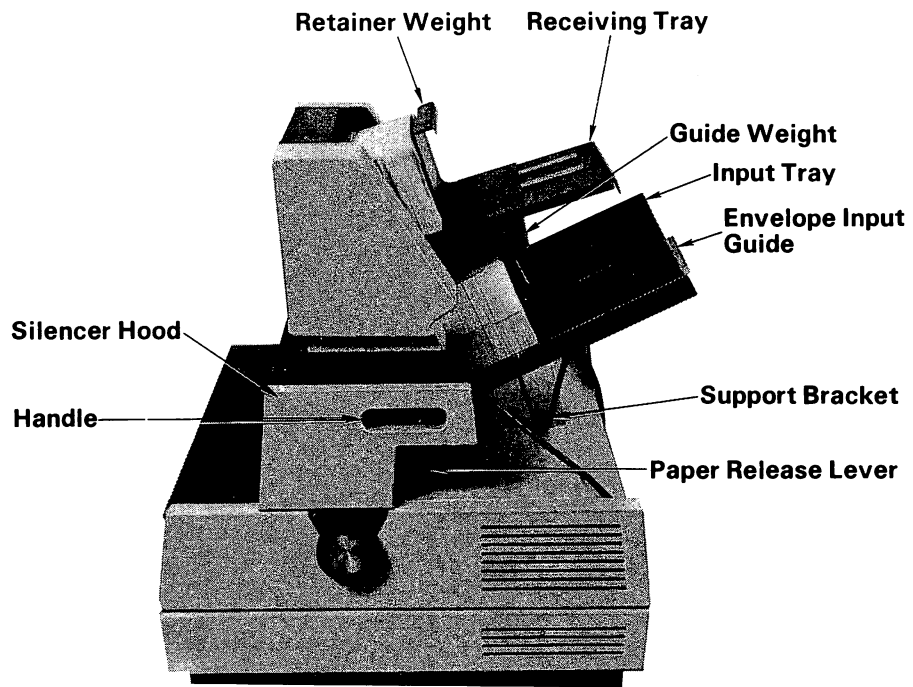

**Figure 1-2. Envelope Feeder**



11  
12



13  
14



## CHAPTER 2 FEEDER OPERATION

### 2.1 MOUNTING AND REMOVAL

The Envelope Feeder is easily mounted on and removed from the 2281W Printer/Plotter. The steps for mounting and removal are described in the following paragraphs.

#### NOTE

Be sure the printer has been properly adjusted by a Wang Service Representative before using the Envelope Feeder.

#### Mounting

Installation of the Envelope Feeder on the printer is accomplished by performing the following steps.

1. Turn off the printer. If this is not done, a power-on reset code sequence [HEX(020DOC030F)] must be executed to set printer defaults prior to operating the feeder on the printer.
2. Remove any paper remaining in the platen.
3. Remove the paper scale and the paper rack from the printer (refer to Figure 2-1). The paper scale can be removed by sliding it to the right to release it from its spring-loaded mount. The paper rack can be detached by loosening and removing the four thumb screws that attach it to the printer.
4. Pull the paper bail forward (refer to Figure 2-1). Position the black rollers to the right side of the paper bail.
5. Grasp the feeder by the handles and lift it from its stand. Lower the feeder onto the printer with the observation window facing forward and the door open. The clamps fit on the printer platen on the small bushing on the right side and on the outside groove of the platen bushing on the left side (refer to Figure 2-1).
6. When the feeder is positioned properly, release the handles. The clamps automatically close when the handles are released. Close the feeder door.

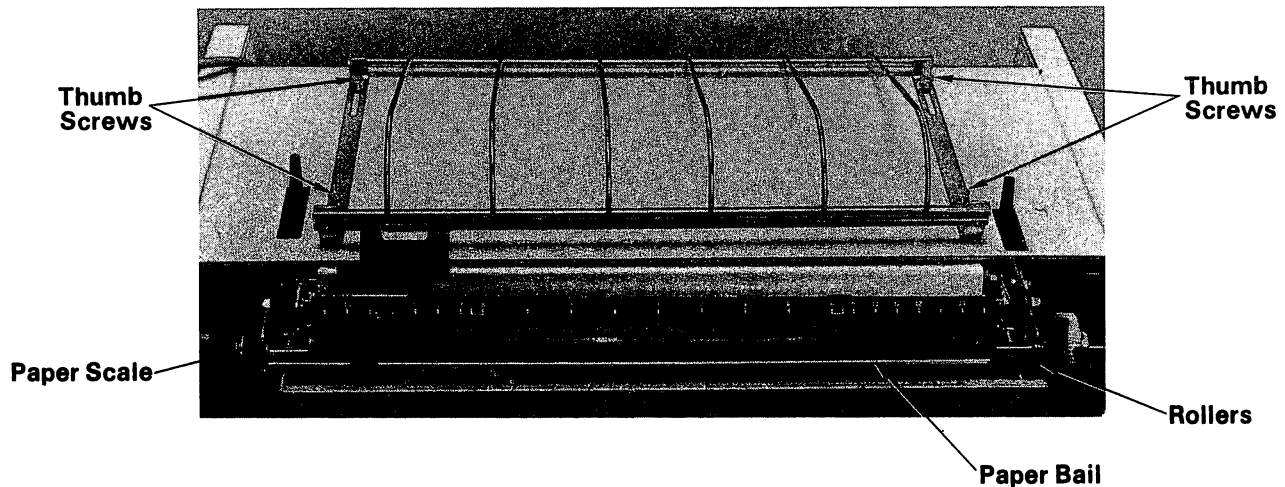

**Figure 2-1. Installation of the Envelope Feeder**

7. Plug the feeder's AC power cord into a separate AC electrical outlet. Plug the interconnector cable on the feeder into the cable receptacle on the back of the printer.
8. Turn the feeder on by pushing in the red ON/OFF button on the front of the feeder; the button will illuminate. The feeder must be powered on before the printer is turned on.
9. Turn the printer on.
10. Set the printer's IMPRESSION (Print Intensity Adjustment) switch to M, move its Paper Release lever to the rear position, and set its Copy Control lever to Position B. Move the Copy Control lever to Position C for thicker envelopes.

The feeder is now ready for use.

### **Removal**

To remove the Envelope Feeder from the printer, perform the following steps.

1. Remove the weights from the input and receiving trays.
2. Turn off the feeder by pushing in the feeder ON/OFF button; the light will extinguish.
3. Turn off the printer. If this is not done, a power-on reset code sequence [HEX(020D0C030F)] must be executed to set printer defaults prior to printer operation.
4. Detach the feeder's interconnector cable from the printer and unplug the electrical cable from the electrical outlet.
5. Open the silencer hood door for a better view of the feeder clamps. Pull up the feeder handles to unlock the clamps and lift the feeder from the printer.



**CAUTION**

Be sure the feeder's interconnector cable and power cord are disconnected before attempting to remove the feeder from the printer.

6. Place the feeder on its stand with the support bracket resting on the bracket stand and the clamps resting on the steel rods on either side of the stand. Release the handles to secure the feeder to the stand.

**NOTE**

When not on the printer, the Envelope Feeder must be placed on its stand to prevent the feeder from being damaged.

## 2.2 LOADING AND REMOVING ENVELOPES

The Wang Envelope Feeder is designed for minimum operator intervention. Loading and removing envelopes are quick and easy processes.

### Loading Envelopes

To load envelopes into the feeder, perform the following steps (refer to Figure 2-2).

1. Make sure the envelope input guide is in the proper grooves for the size of the envelopes being loaded (refer to Section 1.4).
2. Remove the retainer weight and all envelopes from the receiving tray, and raise the receiving tray to the upright position.
3. Fan all envelopes before loading. Make sure the envelopes to be printed are neatly and loosely stacked.

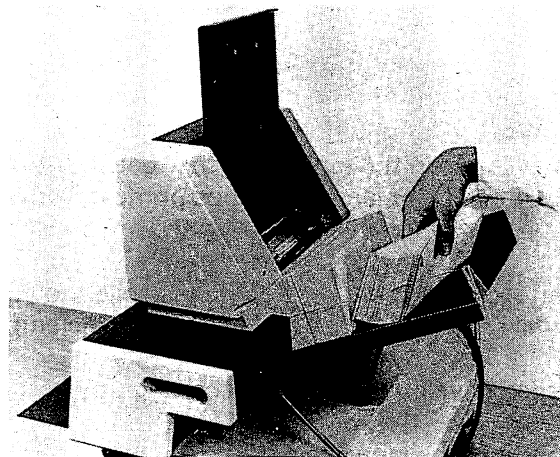

**Figure 2-2. Loading Envelopes**

4. Place the envelopes right side up with the printing surface facing forward in the input tray. Put the guide weight firmly against the last envelope.
5. Lower the receiving tray to its former position.
6. Place the retainer weight in the track and up against the roller at the front of the receiving tray.

**NOTE**

When the feeder is in use, deselect the printer before adding envelopes to the input tray. This will stop printing and prevent envelope jams or feeding problems that might otherwise occur while envelopes are being added.

Do not attempt to load more than 300 envelopes into the input tray at one time.

### Removing Envelopes

To remove envelopes from the feeder, remove the retainer weight from the receiving tray and then remove the addressed envelopes from the tray. To continue operation, load more envelopes as described previously.

**NOTE**

When the feeder is in use, deselect the printer before removing envelopes from the receiving tray. This will stop printing and prevent envelope jams or feeding problems that might otherwise occur while envelopes are being removed.

### Paper Out Condition

When there are no more envelopes in the input tray, the feeder automatically illuminates the printer's RIB/PAPER OUT/COVER UP indicator lamp and stops printing. When this occurs, perform the following steps.

1. Deselect the printer. Any data sent to the printer while the printer is deselected is saved in the printer buffer while new envelopes are loaded into the empty input tray.
2. Remove the addressed envelopes from the receiving tray.
3. Load more envelopes into the input tray.

4. Press either the FEED FRONT or FEED REAR switch on the printer control panel to load a new envelope into the platen.
5. Reselect the printer.

### 2.3 SWITCH-CONTROLLED OPERATIONS

Most Envelope Feeder functions are activated by switches on the printer control panel. Two switch inserts are provided with the Envelope Feeder to identify those operations particular to the feeder. The first insert, CR/LF/FEED FRONT, replaces the printer's CR/LF/↑ switch insert; the second, CLEAR PLATEN/FEED REAR, replaces the printer's TOP OF FORM/↓ switch insert (refer to Figure 2-3).

The lowercase operation of either the CR/LF/FEED FRONT or the CLEAR PLATEN/FEED REAR switch causes the platen to be cleared and a new envelope to be fed to the platen. The uppercase operation of the CLEAR PLATEN/FEED REAR switch causes the platen to be cleared without an envelope feed. If the feeder does not detect an envelope behind the platen when either a Clear or a Feed operation is executed, the Clear command is ignored.



**Figure 2-3. Model 2281W Front Panel Inserts for Envelope Feeder**

### 2.4 ENVELOPE JAMS

Occasionally envelopes may become jammed during a Feed or Clear operation. This section discusses methods by which the operator can clear an envelope jam in the feeder. It should not be considered a guide to repairing the Envelope Feeder. All repairs and maintenance of the feeder must be performed by a Wang Service Representative to keep the feeder warranty in effect.

**WARNING**

Do not, under any circumstances, attempt to remove a jammed envelope from the feeder until the belts have stopped moving.

An envelope most commonly causes a jam when it is wrinkled, imperfectly manufactured, or incorrectly stacked in the input tray. Most jams cause the printer's RIB/PAPER OUT/COVER UP indicator lamp to be illuminated.

The procedures to remedy some possible jams are discussed in the following paragraphs.

### **Jam Before Printing Begins**

Multiple envelopes are fed and jam behind the platen, or a single envelope is fed and jams as it rolls around the platen. If printing has not begun, the jam can be cleared with no data loss. In order to accomplish this, perform the following steps.

1. Deselect the printer.
2. Remove the Envelope Feeder from the printer and place it on its stand.
3. Manually remove any jammed envelopes.
4. Replace the Envelope Feeder on the printer.
5. Press the printer's lowercase FEED FRONT or FEED REAR switch to feed an envelope to the printer.
6. Reselect the printer.

When the printer is reselected, printing will resume. No data should be lost, because printing was not interrupted when the jam occurred.

### **Jam During Printing**

Multiple envelopes are fed to the printer. Printing begins, but the multiple envelope feed causes a jam in the platen, which interrupts the printing operation. To clear the jam, perform the following steps.

1. Deselect the printer.
2. Press the printer's uppercase CLEAR PLATEN switch to clear the envelope from the platen.
3. Press the printer's lowercase FEED FRONT or FEED REAR switch to feed an envelope to the platen.
4. Reselect the printer.

When this type of jam occurs, any data that has already been printed will no longer be available from the print buffer. When the printer is reselected, printing resumes with the data remaining in the buffer.

#### **NOTE**

Never pull an envelope backwards through the platen when clearing a jam. Always move the envelope through to the front of the platen.

Never reuse jammed envelopes.

## CHAPTER 3 PROGRAMMABLE OPERATION

### 3.1 INTRODUCTION

The Envelope Feeder may be operated under program control through use of the printer control codes discussed in Chapter 5 of the *Model 2281W Printer Plotter User Manual*. Additional hex control codes provide special functions for the feeder operator. These control codes are described in the following sections.

#### NOTE

Use of the Envelope Feeder prohibits plotting operations. The feeder is not designed to allow envelopes to move in a reverse direction around the platen. Serious envelope jams may occur if such an attempt is made.

### 3.2 CLEAR PLATEN: HEX(02030F)

The Clear Platen command causes an envelope currently in the platen to be cleared and stacked in the receiving tray without causing a new envelope to be fed to the platen. If the feeder does not detect an envelope behind the platen, the Clear command is ignored.

### 3.3 ENVELOPE FEED: HEX(0C)

The Envelope Feed command causes the envelope currently in the platen to be cleared and stacked in the receiving tray and a new envelope to be fed from the input tray. If the feeder does not detect an envelope behind the platen, the Clear command is ignored and only the Feed command is executed.

### 3.4 SETTING ENVELOPE LENGTH AND HEIGHT

When powered on, the Envelope Feeder sets defaults for the length and height of #10 envelopes (refer to Figure 3-1). When envelopes of other sizes are used, the BASIC program must be used to reset envelope length and height.

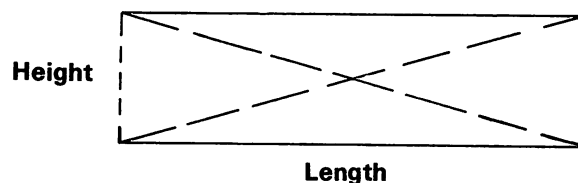

Figure 3-1. Envelope Length and Height

## Envelope Length

Envelope length is set by means of the SELECT PRINT statement (refer to Chapter 2 of the *Model 2281 W Printer/Plotter User Manual*). This statement is used to select the address of the printer and specify the maximum number of characters to be printed per line. For example:

```
10 REM SET THE LENGTH FOR # 7 3/4 ENVELOPES AT 10-PITCH
20 SELECT PRINT 204 (74)
```

Table 3-1 lists the maximum number of 10- and 12-pitch characters per line that can be printed on the three sizes of envelopes accommodated by the Envelope Feeder. The values listed in the right column are the maximum values that may be used as XXXX values in the Move commands and Set Left Margin commands discussed in Section 5.2 of the *Model 2281 W Printer/Plotter User Manual*.

**Table 3-1. Envelope Length Specifications**

Envelope Size	Characters		Right Margin Limit in 1/60-Inch Increments (XXXX)
	10-pitch	12-pitch	
# 7 3/4	74	94	01EE hex
#9	88	105	0240 hex
#10	94	113	0261 hex

## Envelope Height

The Set Envelope Height command, HEX(020C0102YYYY0F), sets the bottom margin for all printing operations on each envelope. It thus enables the user to specify the height of the printing area of each envelope. Whenever the bottom margin of the printing area is reached, an automatic envelope feed is executed, clearing the current envelope and feeding a new envelope from the input tray. Printing automatically continues on the newly fed envelope.

When an envelope is fed behind the platen, the top margin is set at approximately 1.5 inches from the top edge. The height of the print area is measured from this point to the bottom edge of the envelope. The YYYY sequence of the Set Envelope Height command is a positive hexadecimal value representing the end of the available print area. For example:

```
10 REM SET THE HEIGHT FOR #9 ENVELOPES
20 PRINT HEX(020C010200700F)
```

As a result of this statement, when the printer reaches the bottom line of the envelope, it ejects the envelope to the receiving tray, and the feeder feeds a new envelope to the printer.

**NOTE**

Whenever changing to a new envelope size, the user should execute a Set Envelope Height command. (The YYYY values to be used are supplied in Table 3-2.)

Table 3-2 lists the hex value of the maximum number of 1/48-inch incremental movements (YYYY) that can be made vertically on envelopes of the three sizes accommodated by the Envelope Feeder.

**Table 3-2. Envelope Height Specifications**

<b>Envelope Size</b>	<b>Number of Print Lines Available</b>	<b>Envelope Height Limit in 1/48-Inch Increments (YYYY)</b>
#7 3/4	14	0070 hex
#9	14	0070 hex
#10	15	0078 hex

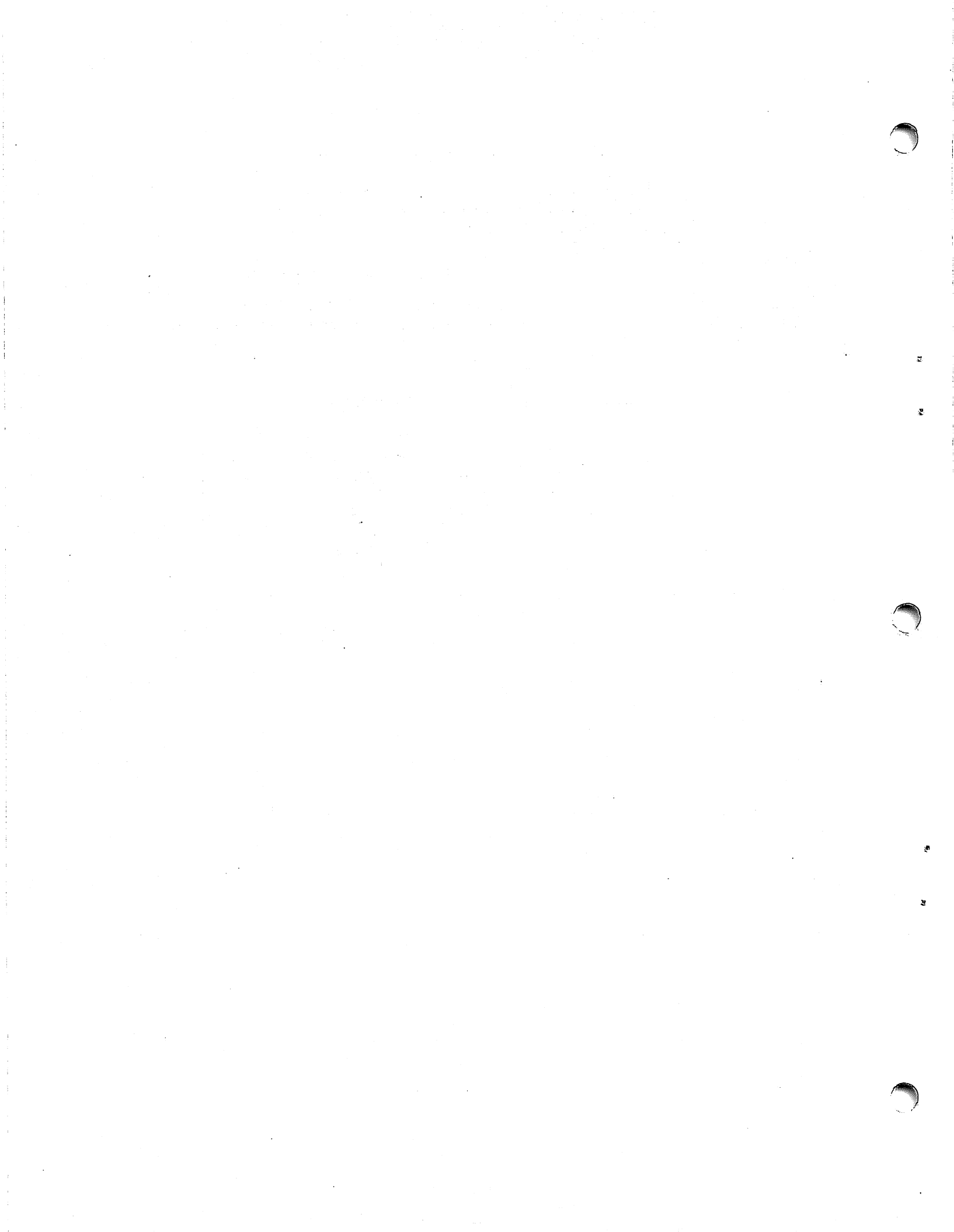



## **CHAPTER 4**

### **GENERAL CARE AND MAINTENANCE**

This chapter lists some procedures that should be strictly followed to keep the Envelope Feeder running smoothly.

#### **4.1 THINGS TO DO**

1. Always fan envelopes before loading.
2. Remove old envelopes from the input tray and restack them when adding new envelopes. Refan envelopes before reloading the input tray.
3. Be aware that changes in humidity can affect envelopes. If envelopes have been stored in a humid area, they should be allowed to stand for 24 hours in a room of normal humidity before they are put through the feeder.
4. Remember to unplug the feeder and detach the interconnector cable before removing the feeder from the printer, unless the feeder is temporarily removed to clear an envelope jam.
5. Place feeder in stand when it is not in use.

#### **4.2 THINGS TO AVOID**

1. Do not attempt to use envelopes sizes other than #7 3/4, #9, and #10 in the feeder.
2. Do not mix different sizes of envelopes.
3. Do not use wrinkled, curled, or previously jammed envelopes.
4. Do not attempt to feed used or previously stuffed envelopes into the feeder.
5. Do not overload. Do not attempt to load more than 300 envelopes into the feeder at one time.
6. Never reach into the feeder when it is operating.
7. Do not load or unload envelopes while the feeder is operating.
8. Do not leave envelopes in the feeder overnight.



2

14



15

16



## APPENDIX A ENVELOPE FEEDER SPECIFICATIONS

### MODELS

Model	Envelope Sizes
EF-11	#7 3/4, #9, #10
EF-12	#7 3/4, #9, #10
EF-13	Minimum: 3.875 in. x 7.5 in. (98.4 mm x 190.5 mm) Maximum: 4.250 in. x 8.875 in. (108.0 mm x 225.4 mm)

### PHYSICAL DIMENSIONS (ALL MODELS)

Height	14.0 in. (36.1 cm)
Depth	17.0 in. (42.4 cm)
Width	23.5 in. (58.5 cm)

### WEIGHT

28.5 lb (13.0 kg)

### ENVELOPE SIZES

Type	Width/Length
#7 3/4	3.875 in. x 7.5 in. ( $\pm 0.03125$ in.) (98.4 mm x 190.5 mm)
#9	3.875 in. x 8.875 in. ( $\pm 0.03125$ in.) (98.4 mm x 225.4 mm)
#10	4.125 in. x 9.5 in. ( $\pm 0.03125$ in.) (104.8 mm x 241.3 mm)

Warpage of new envelopes shall not exceed 0.50 inch. Self-sealing envelopes cannot be used with the Envelope Feeder.

### CAPACITY

Input Tray	300 envelopes
Receiving Tray	300 envelopes

## PAPER GRADE

20 lb (± 1.10 lb)	0 to 50% rag content
22 lb (± 1.10 lb)	0 to 50% rag content
24 lb (± 1.10 lb)	0 to 50% rag content

## SWITCHES AND INDICATORS

Illuminating power button

## INSTALLATION

Feeder latches to platen and rests on rear of cover.  
Electric cable connects feeder to Model 2281W Printer/Plotter.  
Power cable connects feeder to conventional office electrical outlet.

## POWER REQUIREMENTS

Model	Power
EF-11	115 VAC ± 10 %, 60 Hz ± 1 Hz, 50 W
EF-12	230 VAC ± 10 %, 50 Hz ± 1 Hz, 50 W
EF-13	230 VAC ± 10 %, 50 Hz ± 1 Hz, 50 W

## FUSE

1.0 amp (SB)

## CABLE

6-ft AC power cord  
Interconnector cable to printer

## OPERATING ENVIRONMENT

50° to 80° F (10° to 27° C)  
30% to 55% relative humidity, noncondensing (recommended)  
20% to 70% relative humidity, noncondensing (allowable)

### NOTE

Envelope Feeder operation may not meet specifications if envelopes are adversely affected by environmental conditions.

## STORAGE CLEARANCE

Height	20.0 in. (50.8 cm)
Depth	20.0 in. (50.8 cm)
Width	30.0 in. (76.2 cm)

# INDEX

Adjustment .....	2-1
Cable .....	1-2, 2-2, A-2
Clear Platen Command .....	3-1
Envelope Feed Command .....	3-1
Envelope Height .....	3-1, 3-2 to 3-3
Envelope Input Guide .....	1-2, 1-3, 2-3
Envelope Insertion .....	2-3 to 2-4
Envelope Jams .....	2-5 to 2-6
Envelope Length .....	3-1, 3-2
Envelope Removal .....	2-4
Envelope Sizes .....	A-1
Envelope Specifications .....	A-2
Environment .....	4-1
Fuse .....	A-2
Guide Weight .....	1-2, 1-3, 2-2
Handles .....	1-2, 1-3, 2-1
Hood .....	1-2, 1-3
Humidity .....	A-2
Input Tray .....	1-1, 1-3, 2-4, A-1
Installation .....	2-1 to 2-2, A-2
Interconnector Cable .....	1-2, 2-2, 2-3, A-2
Jams .....	2-5 to 2-6
Maintenance .....	4-1
Manual Operation .....	2-5
Models .....	A-1
Paper Out Indicator .....	2-4, 2-5
Power .....	A-2
Power Button .....	1-1
Power Cable .....	1-2, 2-2
Programmable Operation .....	3-1 to 3-3
Receiving Tray .....	1-1, 1-3, 2-4, A-1
Removing the Feeder .....	2-2 to 2-3
Retainer Weight .....	1-2, 1-3, 2-2, 2-4
Set Envelope Height Command .....	3-2 to 3-3
Silencer Hood .....	1-2, 1-3
Size .....	A-1
Stand .....	1-2, 2-3
Switch-Controlled Operation .....	2-5
Temperature .....	A-2

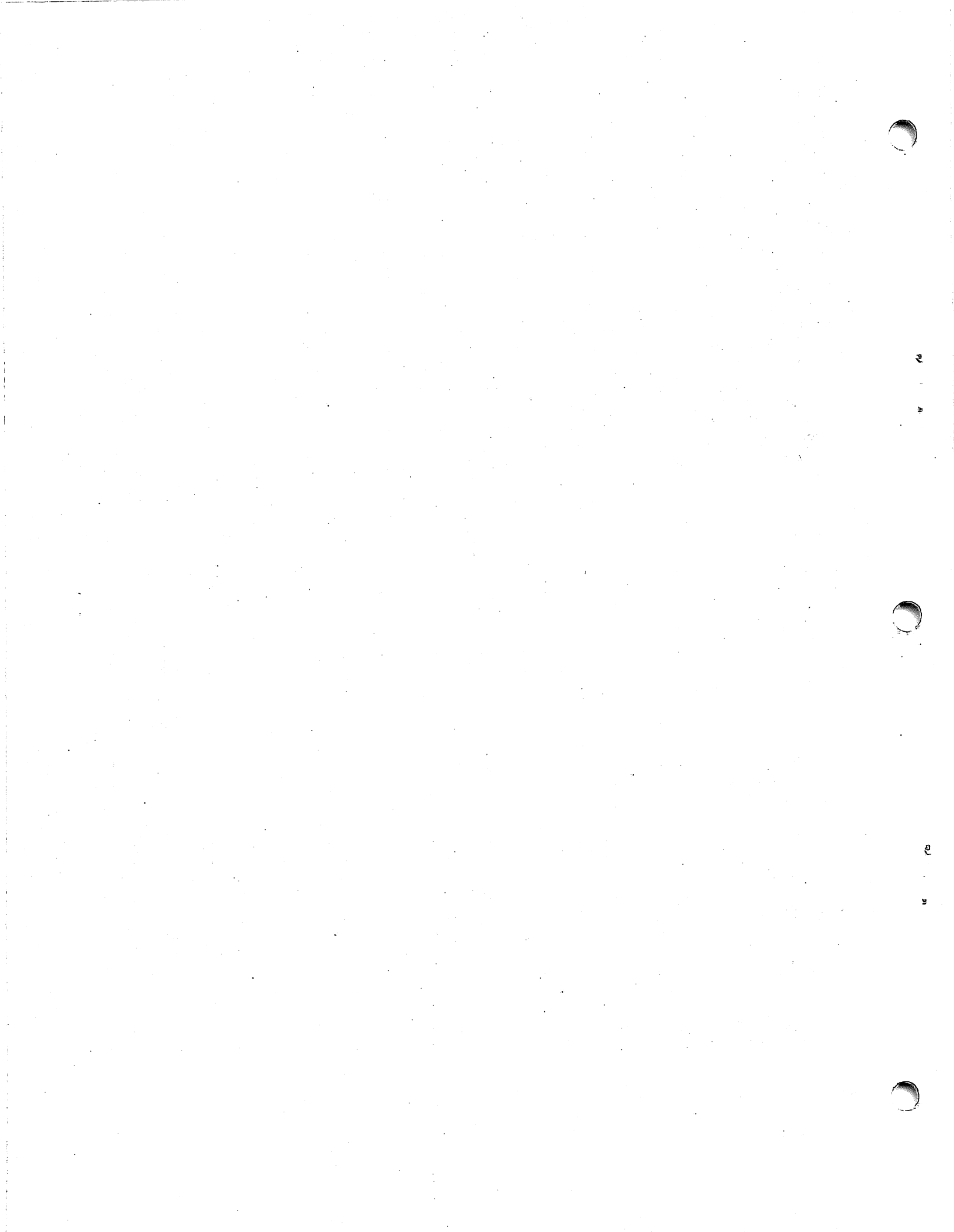

To help us to provide you with the best manuals possible, please make your comments and suggestions concerning this publication on the form below. Then detach, fold, tape closed and mail to us. All comments and suggestions become the property of Wang Laboratories, Inc. For a reply, be sure to include your name and address. Your cooperation is appreciated.

**700-6833**

TITLE OF MANUAL **2200 ENVELOPE FEEDER USER MANUAL**

COMMENTS:

\_\_\_\_\_ Fold

\_\_\_\_\_ Fold

**WANG**

Fold



**NO POSTAGE  
NECESSARY  
IF MAILED  
IN THE  
UNITED STATES**

**BUSINESS REPLY CARD**  
FIRST CLASS      PERMIT NO. 16      LOWELL, MA

POSTAGE WILL BE PAID BY ADDRESSEE

**WANG LABORATORIES, INC.  
ONE INDUSTRIAL AVENUE  
LOWELL, MASSACHUSETTS 01851**

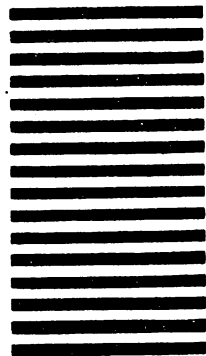

Cut along dotted line.

Attention: Technical Writing Department

Fold





## International Representatives

Argentina  
Bahamas  
Bahrain  
Bolivia  
Botswana  
Brazil  
Canary Islands  
Chile  
Colombia  
Costa Rica  
Cyprus  
Denmark  
Dominican Republic  
Ecuador  
Egypt  
El Salvador  
Finland  
Ghana  
Greece  
Guam  
Guatemala  
Haiti  
Honduras  
Iceland  
India  
Indonesia  
Ireland  
Israel  
Italy  
Ivory Coast  
Japan  
Jordan  
Kenya  
Korea  
Kuwait  
Lebanon  
Liberia  
Malaysia  
Malta  
Mexico  
Morocco  
New Guinea  
Nicaragua  
Nigeria  
Norway  
Paraguay  
Peru  
Philippines  
Portugal  
Qatar  
Saudi Arabia  
Scotland  
Senegal  
South Africa  
Spain  
Sri Lanka  
Sudan  
Tasmania  
Thailand  
Turkey  
United Arab Emirates  
Uruguay  
Venezuela  
Zimbabwe

## United States

<b>Alabama</b> Birmingham Mobile	<b>Florida</b> Coral Gables Hialeah Hollywood Jacksonville Miami Orlando Sarasota Tampa	<b>Iowa</b> Ankeny <b>Kansas</b> Overland Park Wichita <b>Kentucky</b> Louisville <b>Louisiana</b> Baton Rouge Metairie <b>Maine</b> Portland <b>Maryland</b> Baltimore Bethesda Gaithersburg Rockville <b>Massachusetts</b> Boston Burlington Chelmsford Lawrence Littleton Lowell Methuen Tewksbury Worcester <b>Michigan</b> Grand Rapids Kalamazoo Lansing	Southfield <b>Minnesota</b> Eden Prairie Minneapolis <b>Mississippi</b> Jackson <b>Missouri</b> Creve Coeur St. Louis <b>Nebraska</b> Omaha <b>Nevada</b> Las Vegas <b>New Hampshire</b> Manchester <b>New Jersey</b> Bloomfield Clifton Edison Mountainside Toms River <b>New Mexico</b> Albuquerque Santa Fe <b>New York</b> Albany Jericho Lake Success New York City Rochester	Syosset Syracuse Tonawanda <b>North Carolina</b> Charlotte Greensboro Raleigh <b>Ohio</b> Akron Cincinnati Cleveland Independence Toledo Worthington <b>Oklahoma</b> Oklahoma City Tulsa <b>Oregon</b> Eugene Portland Salem <b>Pennsylvania</b> Allentown Erie Harrisburg Philadelphia Pittsburgh State College Wayne <b>Rhode Island</b> Providence	<b>South Carolina</b> Charleston Columbia <b>Tennessee</b> Chattanooga Knoxville Memphis Nashville <b>Texas</b> Austin Dallas El Paso Houston San Antonio <b>Utah</b> Salt Lake City <b>Virginia</b> Newport News Norfolk Richmond Rosslyn Springfield <b>Washington</b> Richland Seattle Spokane <b>Wisconsin</b> Appleton Brookfield Green Bay Madison Wauwatosa
--	---	--	---	---	---

## International Offices

<b>Australia</b> Wang Computer Pty., Ltd. Adelaide, S.A. Brisbane, Qld. Canberra, A.C.T. Perth, W.A. South Melbourne, Vic 3 Sydney, NSW	Victoria, B.C. Winnipeg, Manitoba <b>China</b> Wang Industrial Co., Ltd. Taipei <b>Wang Laboratories, Ltd.</b> Taipei	<b>Japan</b> Wang Computer Ltd. Tokyo <b>Netherlands</b> Wang Nederland B.V. IJsselstein Groningen <b>New Zealand</b> Wang Computer Ltd. Auckland Christchurch Wellington <b>Panama</b> Wang de Panama (CPEC) S.A. Panama City <b>Puerto Rico</b> Wang Computadoras, Inc. Hato Rey <b>Singapore</b> Wang Computer (Pte) Ltd. Singapore <b>Sweden</b> Wang Skandinaviska AB Stockholm Gothenburg	Malmö <b>Switzerland</b> Wang A.G. Zurich Basel Bern Geneva Lausanne St. Gallen <b>Wang Trading A.G.</b> Zug <b>West Germany</b> Wang Deutschland, GmbH Frankfurt Berlin Cologne Düsseldorf Essen Freiburg Hamburg Hannover Kassel Mannheim Munich Nürnberg Saarbrücken Stuttgart
--	---	--	---

# WANG

ONE INDUSTRIAL AVENUE, LOWELL, MASSACHUSETTS 01851. TEL. (617) 459-5000, TWX 710 343-6769, TELEX 94-7421

Printed in U.S.A.  
700-6833  
12-81-1M